



JOCAVI™ Acoustic panels

Acoustic Perfectionism is our Aim

Acoustic Perfectionism is Our Aim



 ABOUT US 4

4  CONCEPTS / PHILOSOPHY 5

(b) ABSORBENT PANELS

ADDSORB	6
ADDSORB REV	7
APL	8
ARCHTRAP	10
CONVEXABSORBER	11
EBONY	12
LEAKY FM	13
JMORSE	14
LIGHTWALLTRAP / CLOUD	15
MELLOWALLTRAP	16
MELLOWCLOUD ABS	17
MELLOWWAFFLE	18
STAITREAT WBA	19
WALLPERF	20
WOODFACE	21
CAMOU	22
BASMEL / CLOUD	23
COSMOS	25
COOKIE / CLOUD	26
DECOART	27
FOAMSORB/ INV	28
NOVEN	29
PET ABS	30
PET REV	31
SEAFOAM	32
SNOWSORB	33
STRIPESORB / ARC	34
SWELL	35
WUSORBER	36
WATERCOT	37
WIDEBAFFLE	38
ASSC	39
ISOBOARD	41

(K) DIFFUSION PANELS

CERAFLECTOR	42
COMPACTFUSER	43
CORKOAK	44
DYNAMICFLOW	45
DIAMOND	46
EFFECTFUSER	47
MELLOWCLOUD DIF	48
NEO 3Q	49
NEO 6Q	50
PLURA	51
RIPPLE	52
SQUARYDIFFUSOR	53
TUNEFLECTOR	54
TWO FX	55
WOODFOIL	56
WOODIFFUSOR	57
WOODQUAD	58
CORALREEF	59
IVORY	60
REFLEX	61
STRIPEFUSER	62
TWIN	63
WAVYFUSER/ INV	64

(M) MUSIC ACCESSORIES

VOCAL MIC	86
BABS	86
HORNDIFFUSER	87
MIC PROTECTOR	87
NEARFIELD BASE	88
SUBWOOFER BASE	88
DRUMBASE	89
KICK PAD KIT	89
WALLBLIND	90
WALLPART	91

(R) ACOUSTIC SHELL

FIXED DIFFUSION	92
PORTABLE DIFFUSION	93

(I) BASSTRAPS

ABSTRACT	65
BASSCORNER	66
BASSLAYER	67
LOWNOTE	68
HUMCUT	70
ROUNDBASSCORNER	72
STAITREAT	73
TONAL	75
TUBABSORBER	77
WALLTRAP	78
BASSKEEPER	79
LF CAMOU	81
LF COSMOS	82
LF TONE	83
SLIMBASS	84
TRAP	85

(E) ECOLOGICAL LINE

ECOISO ABL	96
ECOISO SYSTEM	97
ECOISO SPL	98
GROUTPAINT	99
ECOISO NCF	100
QUADCORK	101

(P) INSULATION

BASMEL CURTAIN	102
ARG	103
SHOCK AB	103
FLOATSHEET	104
STILLNESS	105

(O) OUTDOOR PANELS

AIRBILLOW	108
AIRFLAT	109
AIRHOLED	110
AIRPERF	111
AIRTUBE	112

 ACOUSTIC SHELL INFO 94

 MOTIF 113

 FINISHINGS / COLOURS 115

 PERFORATIONS 131

 ACCESSORIES 130

 WORLDWIDE WORKS 132

ABOUT US

JOCAVI® is a Portuguese company specialized in developing and manufacturing acoustic treatment products for the professional audio industry. As pioneers in the industry, we have built a vast wealth and depth of experience, and established an organizational infrastructure that is second-to-none.

Our passion is both manufacturing and developing new state-of-the-art products and providing our clients with sound acoustic solutions that meet professional working environment needs, while always respecting their corporate image.

As an international reference in the world of acoustics we strive for continued excellence in the development and constant improvement of our products. Utilising computerized calculi and analyses in order to closely determine material characteristics and optimize practical applications.

We're committed to providing original, cutting-edge, technologically innovative, high-quality and durable absorption and diffusion products that deliver excellent performance, at good value - and we do so, with an experienced and highly professional team that is dedicated to ensuring prompt response times and the highest customer satisfaction levels.

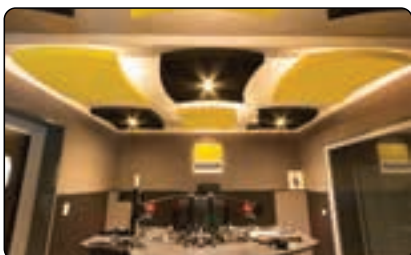

AREAS OF ACTIVITY

JOCAVI® provide personalised solutions for the most demanding ears to all corners of the world. We hold a vast catalogue of highly renowned national and international clients that repeatedly choose JOCAVI® to provide their spaces with sound perfection - from auditoriums, audio studios, commercial or sporting environments, radio stations, theatres, conference rooms and churches to even private listening rooms at home - we have an integrated design solution for any type of space or acoustic need, with our easy to mount panels that flawlessly blend with any desired, or existing décor.

We develop and stock a wide range of high-quality products, enabling a wide variety of applications and design solutions.

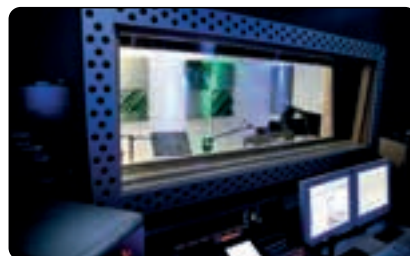

WE ARE ENVIRONMENTALLY FRIENDLY

Over the years JOCAVI® has become increasingly concerned and aware of the need to reduce inert matters that pollute the planet. An issue, we believe the industrial world in particular must pay urgent and careful attention to.

Recycling is all about continuously repeating the life cycle of a given material that has been discarded by society. Giving new life and new uses to such materials is an integral part of our process and corporate commitment.

The recycled materials in our products consist of wood from self-sustainable forests, HIPS, EPS, fabric, ceramics and chipboards. Our painting method uses ecological paints with environmentally harmless dyes and components and no active solvents. In our manufacturing process, the recycled materials range from paper, newspapers, cardboard, magazines, to plastic, packaging, polyester and other textiles to wood and glass.

As we see it, recycling offers infinite advantages. It prevents soil and water contamination, reduces the volume of waste dumped in landfills, spares natural resources and generates jobs.

CONCEPTS AND BUSINESS PHILOSOPHY

ARCHITECTURAL ACOUSTICS

The sound we hear in a room is a combination of the direct sound propagated by the sources and the direct and indirect reflections from the surfaces (floor, walls and ceiling), as well as the limit rate of the room itself (length, width, height). It is by handling the indirect reflections on the surfaces that it is possible to affect and alter the acoustic features of the room and the consequent way we hear and perceive sound considerably. Hence it is one of the central topics in interior acoustics.

The acoustics of buildings was an undeveloped aspect until relatively recent times. In the primordial approaches to this subject the roman architect Marcus Pollio, who lived during the 1st century BC, did some guesswork and pertinent observations regarding the reverberation and interference that could be carried. However, the scientific aspects of the subject were only later developed by the American physicist Joseph Henry in 1856 and more thoroughly by the American physicist Wallace Sabine in 1900. The following years, after the historical landmark that was the Foundation of the architectural acoustics by Sabine, were spent studying how absorption affects sound. At which time, a library was created with absorbent materials, characterized with its respective properties - the absorption coefficients.

COMMON SOUND PROBLEMS IN ROOMS

The acoustics of a room is satisfactorily adequate when there is a correct balance between absorption and sound reflection. That balance is determined by the physical space (dimensions of the room) and by the materials used on the coating. However, the acoustic phenomena like problematic echoes and excessive reflections can frequently occur even in a room with an adequate reverberation time. For instance, when you have a ceiling or a wall with a concave shape, it will be highly reflective. In such cases, the sound is concentrated in a certain point where anomalies are felt and where the sound becomes distorted and unsatisfactory. In the same way, a narrow corridor, connected to a room between parallel reflective walls, can work as a trap, an absorbent chamber is generally beneficial for the lower frequencies. Although the level of absorption of a room is being controlled, other acoustic imperfections can emerge and cause uncomfortable reflections and repeated echoes. It is imperative to pay attention to the elimination of these interferences. Interferences emerge from the difference of distance from the direct sound and the reflected sound, which produce the so called dead points, where some

ROOM DESIGN

The Acoustic Design of a room should take into consideration the fact that human hearing is complex, whether due to physiological characteristics of the ear or due to psychological characteristics. For example, sounds that are familiar to us are easily and quickly interpreted, on the other hand, those sounds that we consider uncommon are not interpreted in the same way, making them sound unreal. This is due to the part of our brain that focuses and interprets audio, which minimizes the attention to these types of sounds. Based on this, it is easily understandable that sound can be radically altered in an enclosed space. For example, in a gym conditioned by the hard materials of the walls, ceilings and stands, the sound causes sound waves and several beats, increasing the reverberation and totally misrepresenting the sound of the sound sources.

The sound produced in a room is modified by reverberation due to the number of reflections from the surfaces and to all existing elements in that room, as well as the furniture and the audience. For this reason a professional audio room should have a normal reverberation level and intelligibility to ensure the sound's natural playback. To obtain the highest acoustic qualities, rooms are designed in such a way that ensures there is a balance between absorption and diffusion, with minimum discrepancy of the time values versus frequency. The control of the low and mid-low frequencies is therefore essential, through the absorbent elements. Enough reflection by diffusion is equally important to ensure a good natural quality of sound.

The easiest and most common way of treating audio spaces, without doubt, is to exclusively apply absorbent materials. This method is used uniquely for reducing reverberation time by the method of absorption. However, it is not the most correct way of doing so because when you absorb too much you can immediately see a weakening of the high frequencies which will throw the relationship between reverberation times versus frequency off balance. The effect will then seem like a dead environment with the audible high frequencies at lower levels, cancelling the natural harmonics and diminishing the perception of the instrument's timbre. Aside from the conception of the building, room design projects are largely

OUR TASK

The passion for musical acoustics has guided my life since I was a child. My taste for this subject together with the tenacity to create and develop state-of-the-art solutions under the JOCAVI® brand name, has resulted in the development of numerous original, innovative, high-quality acoustic products.

For over 20 years, I have had the pleasure to lay down the path of this journey with the help of those around me, my friends and coworkers. As pioneers in the acoustic industry, I feel accomplished and honored to have had the opportunity to dedicate my work to what I love most.

Based on reasonable, widely accepted standards, this notion and organized comprehension on how absorption helps hearing perceptibility, begun to be strongly applied in room acoustic projects. The international standards were created with collaboration from standards normalization institutions; ISO, ASTM, etc.

Architectural acoustic experts study the behavior of sound in closed or semi-open enclosures, as well as the sound transmission between buildings. Sound absorption and diffusion is crucial when studying the behavior of sound in closed rooms to ensure good intelligibility of speech and music.

Sound insulation in buildings in general, as well as in urban projects, is important to minimize the propagation of undesired sounds between rooms and adjacent buildings. In this way, the negative acoustic effects are minimized, like noise contamination and misrepresentation of frequencies arising from several factors.

frequencies are cancelled as we do not feel them or hear them. All these acoustic phenomena, called interferences, simultaneously impair hearing and the sound capture by microphones.

When we talk about a "good room sound" we are probably talking about acoustics based on acoustic science discussed for hundreds of years. Until then, good acoustics were achieved by experimentation, experience or simply by accident. Currently, we know a lot about the parameters that influence the sound in a room. Talking about the control room of a studio, we know that, this room should be as neutral as possible, have the right dimensions and proportions and utilize the recommended materials so it can be balanced in all its sound spectrum, but this is not always the case. Here is a list of important parameters to take into consideration to achieve good acoustics: appropriate reverberation time, modal consistency, no floating echoes, good sound distribution, appropriate sound pressure level and low level of background noise achieved by insulation; among others.

executed by the general architectural sector. This also applies to the acoustic design of room interiors.

In most cases this procedure does not deliver the best results, as architects will naturally not have the same sensibility or understanding of acoustics as musicians or engineers, who have been specifically trained to have a higher sensitivity.

For the generalist planners, using diffuser elements can be a risk when not applied in the right shape or proportion. They may choose more standardized solutions using only absorbents, without using diffuser elements, which require much more elaborate understanding. This can result in giving less importance to how reflection by diffusion can help the balance of the reverberation times, and the consequent good environment intelligibility. It is therefore absolutely imperative to consider the application of the diffusing elements in interior room acoustic project planning and design.

Over the last years, a higher sensitivity to the use of diffusers has been noted, and JOCAVI® with its precious range of products, has immensely contributed to that reality. The use of diffusers represents a very conscientious work for the planner, as they cannot introduce excessive reverberation on any frequency, nor echo certain frequencies in an odd way, nor produce undesirable interference effects or distortion. It is therefore, an attractive product that excites the experts.

There are some available methods that make it possible to modulate the acoustic field associated to a sound source, regarding a certain position or area within a room. A very well-known geometrical modulation method is Ray Tracing.

This computation technique is much more demanding than a simple mathematical calculation. It requires a processing unit which makes the calculation slower. The method allows the planner to choose, adjust and distribute the handling of acoustic materials and surface coating based on the required reflection control, diffusion and absorption properties versus the frequency range, to achieve the desired acoustics for the sound source and audience.

JOCAVI® has now over 100 different internationally renowned acoustic products on the market, catalogued, organized and available for the most complex and demanding applications, as well as for the more practical and simple uses in the world of environmental acoustics. We are always innovating and improving.

Welcome to JOCAVI®, and our full range of Acoustic Solutions.

Yours faithfully,,

João Carlos Vieira



ADDSORB®
ABSORBENT PANEL

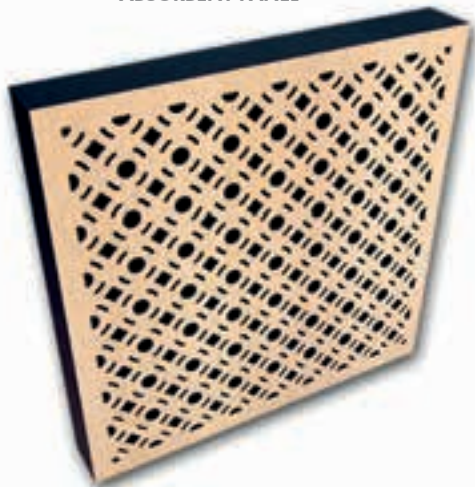

Image of 60x60cm model Ref.:ADD060 (on the left) and Ref.:ADD060 (ambient image).

DESCRIPTION

This panel is mainly used for application in auditoriums, conference rooms, multipurpose rooms, places where acoustic treatment with a continuous coating surface is required. It is an absorbent panel that provides a relevant balance in the mid-range of the sound spectrum and also combines features of a unidirectional diffuser.

There are six types of perforations that give this product several aesthetic and acoustic variants.

This product uses three absorbent materials inside it which have different densities that allow different degrees of permeability, thus making it more efficient at absorbing sound. In large areas, its application may be continuous or modular, thus combining features of other products from this catalogue.

Although this panel is manufactured in standard sizes, other measurements can be considered depending on each project.

This product is very popular because the use of wood in rooms makes them look comfortable.

FEATURES

- Uses 80% of recycled materials.
- NRC : (ADD 0.56/m²), (ADDHC 0.71/m²), (ADDG 0.60/m²) (ADDLS 0.78/m²), (ADDSL 0.79/m²), (ADD0 0.81/m²).
- Fire-resistance: Euroclass B-s2,d0 (similar to old M1).
- 100% recyclable.
- Installation: accessories included.
- Other sizes are available on demand.

TECHNICAL DRAWINGS

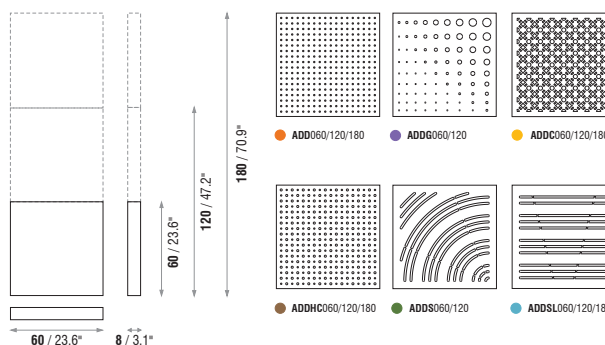

MODELS AND SIZES

MODELS	HEIGHT	WIDTH	DEPTH	WEIGHT
ADD180	180 cm (70.9 in)	60 cm (23.6 in)	8 cm (3.1")	18.9 Kg (41.67 lbs)
ADD120	120 cm (47.2 in)	60 cm (23.6 in)	8 cm (3.1")	12.6 Kg (27.78 lbs)
ADD060	60 cm (23.6 in)	60 cm (23.6 in)	8 cm (3.1")	6.3 Kg (13.89 lbs)

- ADD060/120/180
- ADDG060/120
- ADDC060/120/180
- ADDHC060/120/180
- ADDS060/120
- ADDSL060/120/180

ABSORPTION COEFFICIENT

αS	0.04	0.07	0.09	0.36	0.47	0.52	0.66	0.59	0.55	0.63	0.67	0.70	0.67	0.55	0.50	0.46	0.44	0.41	0.39	0.44	0.48	0.49	0.51	0.50	0.56	
αS	0.04	0.08	0.15	0.39	0.47	0.54	0.61	0.72	0.75	0.71	0.79	0.81	0.84	0.81	0.76	0.57	0.52	0.55	0.49	0.52	0.54	0.55	0.55	0.57	0.57	0.71
αS	0.04	0.08	0.12	0.37	0.50	0.54	0.60	0.61	0.60	0.67	0.70	0.72	0.68	0.59	0.56	0.51	0.49	0.48	0.44	0.48	0.50	0.58	0.58	0.56	0.60	
αS	0.02	0.08	0.15	0.39	0.46	0.55	0.63	0.69	0.67	0.72	0.78	0.83	0.87	0.86	0.84	0.83	0.77	0.74	0.72	0.69	0.68	0.62	0.60	0.60	0.78	
αS	0.03	0.06	0.15	0.41	0.48	0.59	0.65	0.70	0.68	0.72	0.79	0.86	0.91	0.89	0.85	0.80	0.76	0.70	0.74	0.71	0.67	0.60	0.59	0.61	0.79	
αS	0.04	0.07	0.16	0.36	0.49	0.60	0.67	0.75	0.79	0.78	0.80	0.85	0.86	0.90	0.92	0.90	0.79	0.74	0.72	0.69	0.71	0.68	0.66	0.64	0.81	

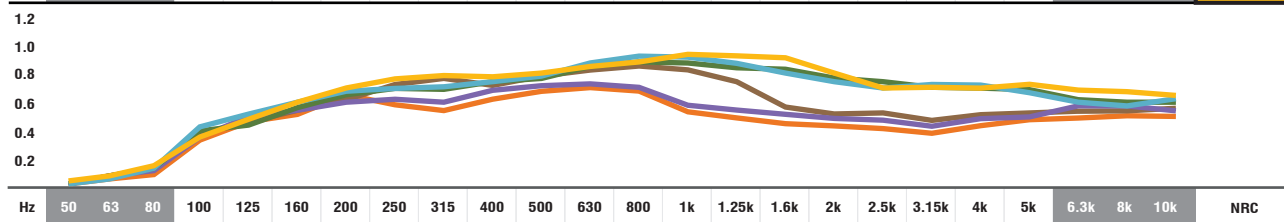

• ABSORPTION COEFFICIENT: Values in accordance with the standards: EN 20654, ASTM C423 and EN 11654. ■ Values [<100 Hz and >5 K] are Non Standard Values.

ENGINEERED COLOURED WOOD COLOURS

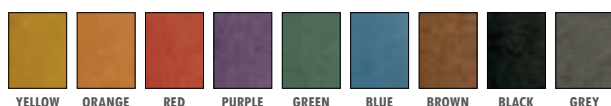

WOOD VENEER FINISHINGS



IMPORTANT NOTICES

- JOCAVI® accepts no responsibility for any printing errors. Specifications can be modified without prior notice, if technical or commercial reasons so require.
- The colours shown on this catalogue are only a reference and an illustration of the products finishing. The colours shown are not binding because brightness, contrast and colour balance may vary due to the printing process.
- Colours may vary due to raw-material suppliers' changes and some differences may occur in tonal range.
- Due to its natural origin, wood-based products will always present natural imperfections inherent to the organic nature. And for similar reasons, they will also present traces of old-age in the course of time.
- Wood and Fabric products are highly susceptible to change its appearance with humidity and temperature. Close attention must be paid to the storage conditions and the acclimatization before, during and after the installation.
- Typical Indoor Comfort Standards state a temperature range of 20°C - 27°C (68°F - 81°F), and a relative humidity of less than 60%. These would be considered as normal operational levels of JOCAVI® products' range.
- Despite all the standard sizes of all products, this model can be customised upon previous consultation. Sizes may vary slightly due to their production method and some inherent raw-materials characteristics.

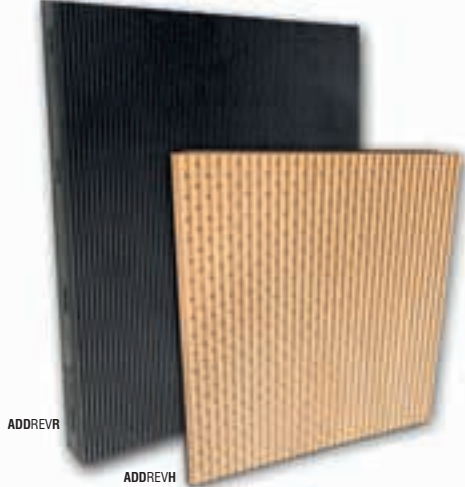

ADDREVR

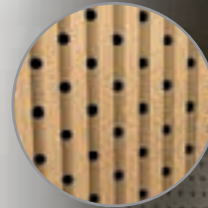

ADDREVH

Image of Addisorb[®] REV models Ref.:ADR colour and Ref.:ADRH wood (on the left) and Ref.:ADRH colour (ambient image).

DESCRIPTION

The ADDSORB REV[®] revetment is a composite wood veneer finish consisting of a medium/high density coloured fibreboard (Engineered Coloured Wood) which is grooved on the face and perforated on the back, its box interior is filled with an acoustic foam absorbent layer.

The ADDSORB REV[®] revetment is also available, as an option, in natural wood veneer finish consisting of high density fibreboard (HDF).

This type of acoustic covering is mainly used for large-scale areas of application: auditoriums, conference rooms, multipurpose rooms, airports, places where acoustic treatment with a continuous coating surface is required.

It is an absorbent panel that relevantly improves absorption in the mid-range of the sound spectrum.

The ADDSORB REV[®] is presented in both standard and customised sizes providing different aesthetic and acoustic variants. These two finish options give this product a variety of natural wood finishes and colours. Due to their slots, the panel joints are invisible because of the change in geometry of the panel edges, and when carefully installed the surfaces can appear uniform.

The acoustic absorption coefficients are achieved by combining the percentage of the plate's grooves and perforation with the acoustic foam absorbent layer. The acoustic performance may be increased if the product is applied with an air space between the product and the main wall or ceiling. The ADDSORB REV[®] is available for both ceiling and wall applications. It can be installed using the standard metal ceiling suspension system or direct fixing to the concrete surface using our accessories.

JOCAVI[®] can customize the sizes, perforations, colours and finishes, according to each specific project, but a minimum amount is required.

FEATURES

- Finish: Coloured wood veneer and wood finishings.
- NRC : (ADDREVR 0.74/m²), (ADDREVH 0.77/m²).
- Perforations (%): (ADDREVR 25.8%), (ADDREVH 11.2%).
- Fire-resistance: Euroclass B-s2,d0 (similar to old M1).
- Standard and customised grooves and perforations.
- 100% recyclable
- Installation: metal or wood bars, glues and/or screws, can be included.
- Other sizes are available on demand, between dimensions of:
Min. 60x60x4.6cm (23.6"x23.6"x1.8") - Max. 180x120x4.6cm (70.9"x47.2"x1.8")
- Aluminium optional mounting bars sold separately

ABSORPTION COEFFICIENT

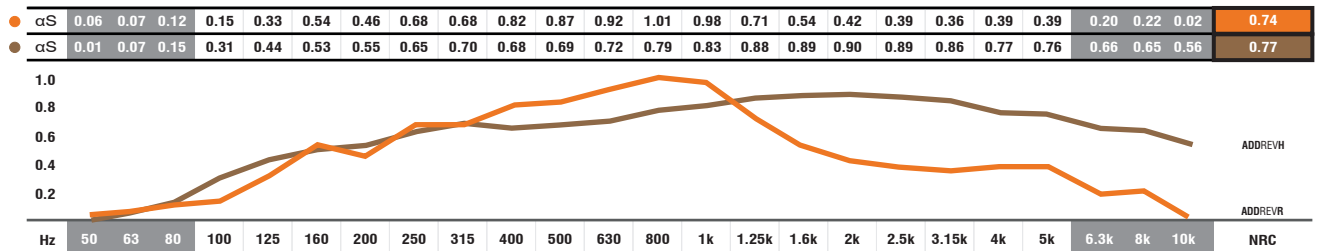

● ● ABSORPTION COEFFICIENT: Values in accordance with the standards: EN 20654, ASTM C423 and EN 11654. ■ Values [<100Hz and > 5K] are Non Standard Values.

ENGINEERED COLOURED WOOD COLOURS



TECHNICAL DRAWINGS

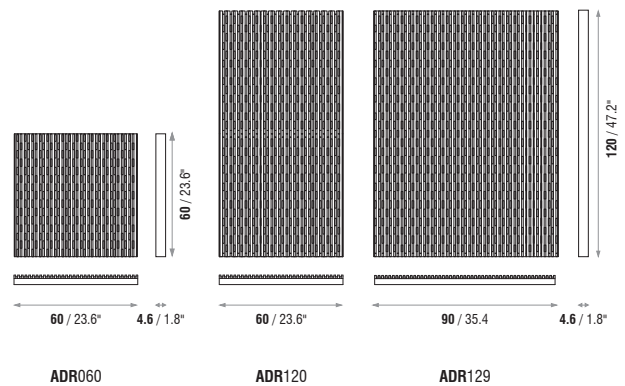

MODELS AND SIZES

MODELS	HEIGHT	WIDTH	DEPTH	WEIGHT
● ADRR060	60 cm (23.6")	60 cm (23.6")	*4,6 cm (1.8")	4,3 Kg (9.48 lbs)
● ADRR120	120 cm (47.2")	60 cm (23.6")	*4,6 cm (1.8")	8,7 Kg (19.18 lbs)
● ADRR129	120 cm (47.2")	90 cm (35.4")	*4,6 cm (1.8")	13 Kg (28.66 lbs)
● ADRH060	60 cm (23.6")	60 cm (23.6")	*4,6 cm (1.8")	4 Kg (8.82 lbs)
● ADRH120	120 cm (47.2")	60 cm (23.6")	*4,6 cm (1.8")	8 Kg (17.64 lbs)
● ADRH129	120 cm (47.2")	90 cm (35.4")	*4,6 cm (1.8")	12 Kg (26.46 lbs)

*5,2cm (2.0") WITH ALUMINIUM MOUNTING BARS (NOT INCLUDED).

WOOD VENEER FINISHINGS



IMPORTANT NOTICES

- JOCAVI[®] accepts no responsibility for any printing errors. Specifications can be modified without prior notice, if technical or commercial reasons so require.
- The colours shown on this catalogue are only a reference and an illustration of the products finishing. The colours shown are not binding because brightness, contrast and colour balance may vary due to the printing process.
- Colours may vary due to raw-material suppliers' changes and some differences may occur in tonal range.
- Due to its natural origin, wood-based products will always present natural imperfections inherent to the organic nature. And for similar reasons, they will also present traces of old-age in the course of time.
- Wood and Fabric products are highly susceptible to change its appearance with humidity and temperature. Close attention must be paid to the storage conditions and the acclimatization before, during and after the installation.
- Typical Indoor Comfort Standards state a temperature range of 20°C - 27°C (68°F - 81°F), and a relative humidity of less than 60%. These would be considered as normal operational levels of JOCAVI[®] products' range.
- Despite all the standard sizes of all products, this model can be customised upon previous consultation. Sizes may vary slightly due to their production method and some inherent raw-materials characteristics.



APL®

ABSORBENT PANELS WITH LIGHTS



Image of 120x60cm model Ref.:BAL120SCL (on the left) and the Ref.:LIGC090L model applied (ambient image).

DESCRIPTION

JOCAVI® supplies high-tech efficient and delicate luminaires and downlights mounted on some of our benchmark absorbent panels.

These two types of LED lamps; luminaires and downlights offer respectively a perfectly uniform or directionality light beam making these a perfect solution for more demanding lighting spaces.

These acoustic panels incorporate highly efficient LED Array, comprised a rail of direct light, suspended by four invisible nylon cables, serving as anchors and electrical wiring. Available on the following models; MELLOWALLTRAP®, LIGHTWALLTRAP®, BASMEL® and COOKIE®.

Perfect for all spaces requiring acoustic absorption along with and at the same time lighting options; for offices, studios or places where the efficiency and comfort are needed.

FEATURES (with Linne S O model)

- Velvety finishing and acoustic foam with fabric;
- Fire-resistance: Euroclass B (similar to old M1);
- HO (High Output Stream); Photometric Code 830-840;
- Luminous Flux 2231/ 2422 (lm); System Efficiency 110/120 (lm/W);
- Temperature Colour: 4000 (K); LED high lifetime (> 50 000h);
- Installation: accessories included;
- Other sizes available on demand.

TECHNICAL DRAWINGS (with Linne S O model)

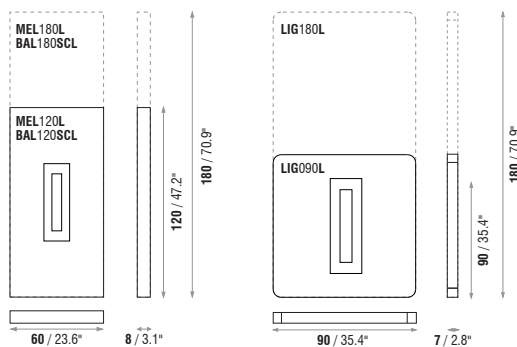

STANDARD FABRIC COLOURS

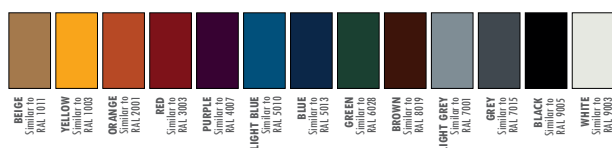

IMPORTANT NOTICES

- JOCAVI® accepts no responsibility for any printing errors. Specifications can be modified without prior notice, if technical or commercial reasons so require.
- The colours shown on this catalogue are only a reference and an illustration of the products finishing. The colours shown are not binding because brightness, contrast and colour balance may vary due to the printing process.
- Colours may vary due to raw-material suppliers' changes and some differences may occur in tonal range.
- Typical Indoor Comfort Standards state a temperature range of 20°C - 27°C (68°F - 81°F), and a relative humidity of less than 60%. These would be considered as normal operational levels of JOCAVI® products' range.
- Despite all the standard sizes of all products, this model can be customised upon previous consultation. Sizes may vary slightly due to their production method and some inherent raw-materials characteristics.

MODELS AND SIZES

MODELS	HEIGHT	WIDTH	DEPTH	WEIGHT
MEL180L/ LB	180 cm (70.9 in)	60 cm (23.6 in)	8 cm (3.1 in)	14.2 Kg (31.31 lbs)
MEL120L/ LB	120 cm (47.2 in)	60 cm (23.6 in)	8 cm (3.1 in)	9.5 Kg (20.94 lbs)
LIG180L/ LB	180 cm (70.9 in)	90 cm (35.4 in)	7 cm (2.8 in)	22.5 Kg (49.60 lbs)
LIG090L/ LB	90 cm (35.4 in)	90 cm (35.4 in)	7 cm (2.8 in)	12.7 Kg (28.00 lbs)
LIGR120L/ LB	-	Ø 120 cm (47.2 in)	7 cm (2.8 in)	12.4 Kg (27.34 lbs)
LIGR090L/ LB	-	Ø 90 cm (35.4 in)	7 cm (2.8 in)	9.3 Kg (20.50 lbs)
LIGC090L/ LB	90 cm (35.4 in)	90 cm (35.4 in)	7 cm (2.8 in)	10.1 Kg (22.27 lbs)
BAL180SCL	180 cm (70.9 in)	60 cm (23.6 in)	8 cm (3.1 in)	3.13 Kg (6.90 lbs)
BAL120SCL	120 cm (47.2 in)	60 cm (23.6 in)	8 cm (3.1 in)	2.12 Kg (4.67 lbs)
COK120SCL	-	Ø 120 cm (47.2 in)	6 cm (2.4 in)	1.10 Kg (0.46 lbs)

FEATURES (with Elementare model)

- Velvety finishing and acoustic foam with fabric;
- Fire-resistance: Euroclass B (similar to old M1);
- HO (High Output Stream); Photometric Code 827-940;
- Luminous Flux 4032/ 3752 (lm); System Efficiency 100-93 (lm/W);
- Temperature Colour: 5000 - 4000 (K); LED high lifetime (> 50 000h);
- Installation: accessories included;
- Other sizes available on demand.

TECHNICAL DRAWINGS (with Elementare model)

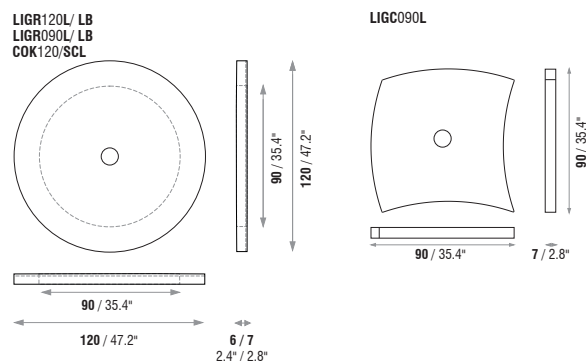

VELVETY COLOURS (only available in Melamine Foam)

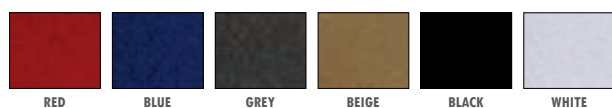

MELLOWALLTRAP®

ABSORPTION COEFFICIENT

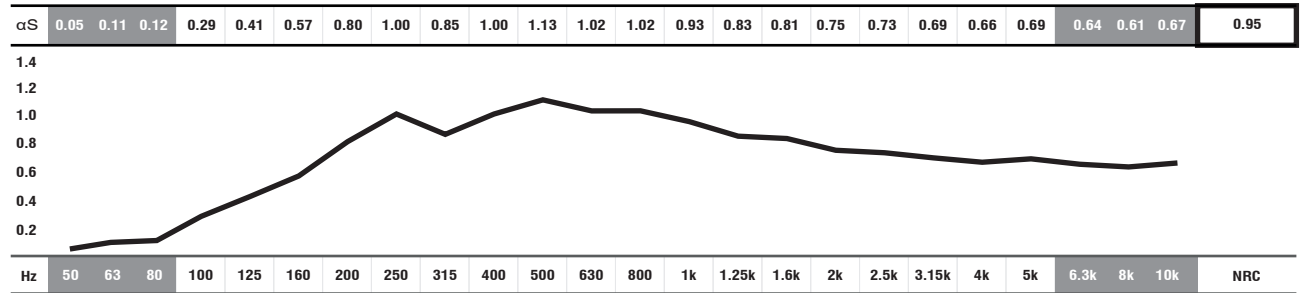

■ ABSORPTION COEFFICIENT: Values in accordance with the standards: EN 20654, ASTM C423 and EN 11654. ■ Values [$<100\text{Hz}$ and $>5\text{K}$] are Non Standard Values.

LIGHTWALLTRAP®

ABSORPTION COEFFICIENT

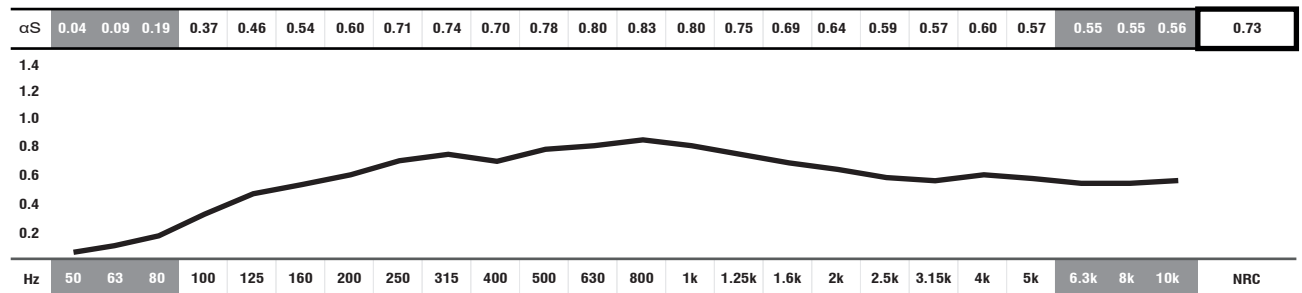

■ ABSORPTION COEFFICIENT: Values in accordance with the standards: EN 20654, ASTM C423 and EN 11654. ■ Values [$<100\text{Hz}$ and $>5\text{K}$] are Non Standard Values.

COOKIE®

ABSORPTION COEFFICIENT*

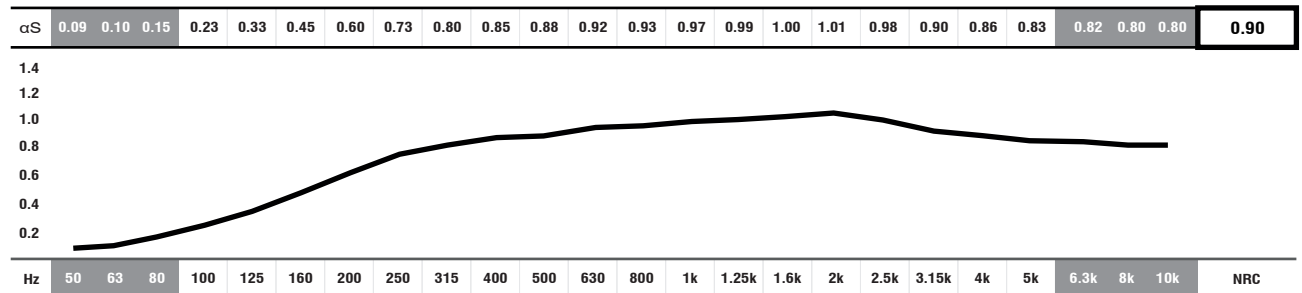

■ ABSORPTION COEFFICIENT: Values in accordance with the standards: EN 20654, ASTM C423 and EN 11654. ■ Values [$<100\text{Hz}$ and $>5\text{K}$] are Non Standard Values.
*PANEL DATA ONLY OF REF.: COK060 VELVETY FINISHING.

BASMEL®

ABSORPTION COEFFICIENT

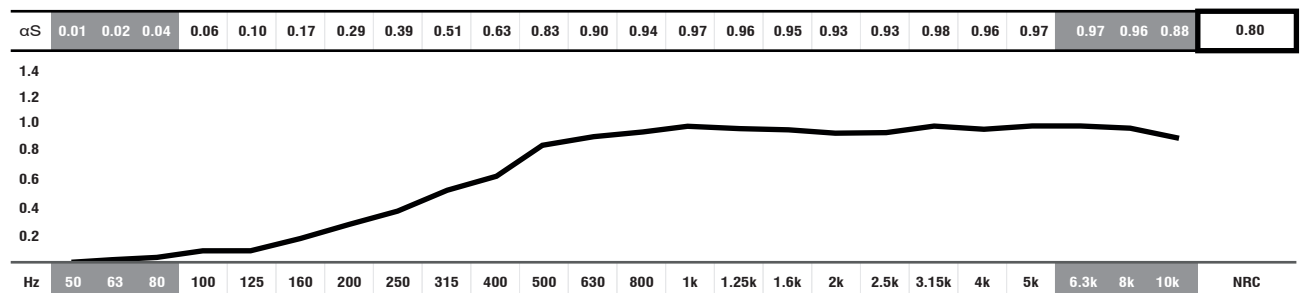

■ ABSORPTION COEFFICIENT: Values in accordance with the standards: EN 20654, ASTM C423 and EN 11654. ■ Values [$<100\text{Hz}$ and $>5\text{K}$] are Non Standard Values.



ARCHTRAP®

ABSORBENT PANEL

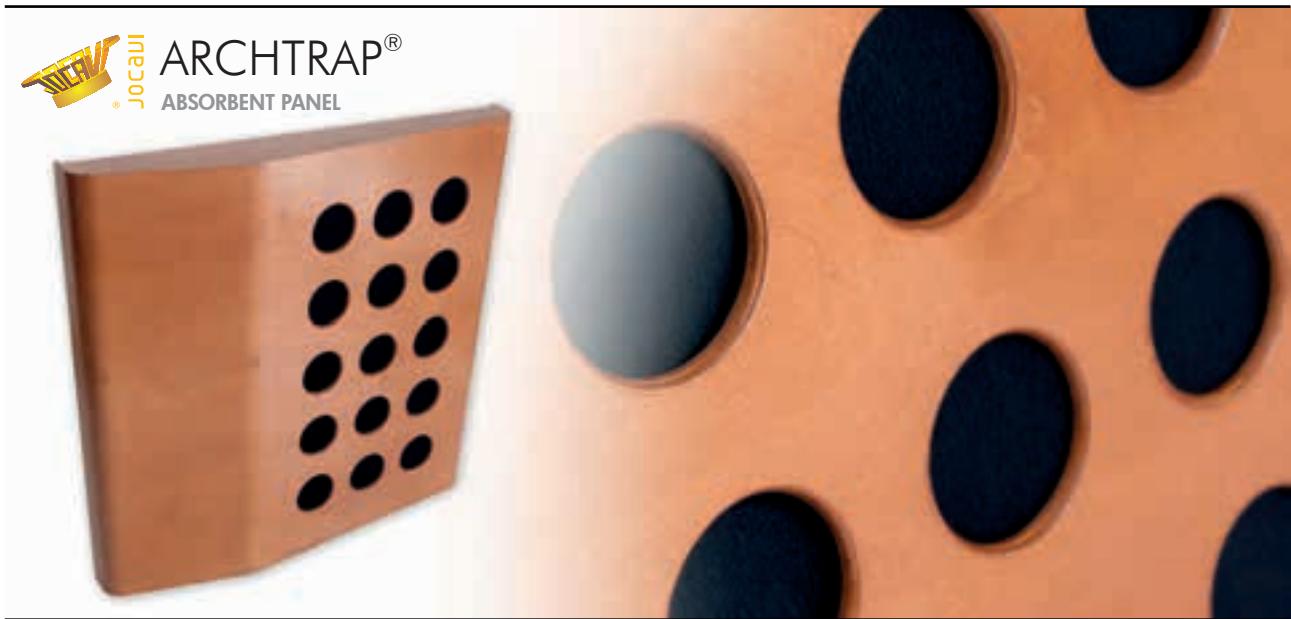

Image of 60x60cm model Ref.:ARC060.

DESCRIPTION

The ARCHTRAP® is a flat-shaped acoustic absorbent panel, made with birch plywood on a calculated absorbent box. This panel is meant to absorb mid-low range frequencies. Its shape is the same as the ATP® Snowsorb® and both can be used together to achieve numerous sound absorption solutions.

We can make several different aesthetic effects by rotating the panels 90° degrees and positioning them according to one's taste and to the room requirements.

As this panel is made of varnished birch plywood, it also provides some scattering diffusion. When using multiple pieces jointly, the angle of incidence never is too convergent which leads to a homogeneous sound scattering.

This piece is available in various wood finishings or regular colours, thus allowing an appropriate background for each space. The mounting process is rather easy by simply using the docking accessories' screws that are supplied.

TECHNICAL DRAWINGS

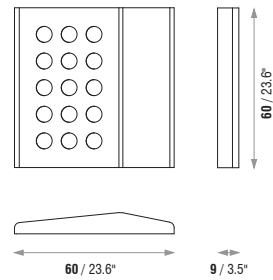

FEATURES

- Manufactured in birch plywood.
- NRC: **0.63/m²**.
- Average diffusion: **0.48/m²** [$>100\text{Hz}; <5\text{KHz}$].
- Fire-resistance: Euroclass B-s2,d0 (similar to old M1).
- Recyclable.
- Installation: accessories included.
- Several colours available.

MODELS AND SIZES

MODELS	HEIGHT	WIDTH	DEPTH	WEIGHT
ARC060	60 cm (23.6 in)	60 cm (23.6 in)	9 cm (3.5 in)	5 Kg (11.02 lbs)

DIFFUSION - ABSORPTION COEFFICIENT

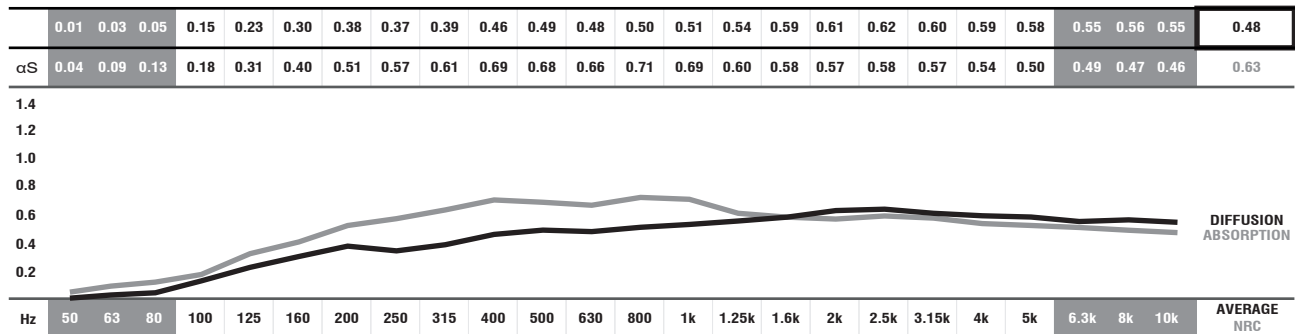

■ ABSORPTION COEFFICIENT: Values in accordance with the standards: EN 20654, ASTM C423 and EN 11654. ■ Values [$<100\text{Hz}$ and $> 5\text{K}$] are Non Standard Values.
 ■ DIFFUSION COEFFICIENT: These values were obtained by mathematical calculations and tests carried out in our laboratory.

WOOD VENEER FINISHINGS



IMPORTANT NOTICES

- JOCAVI® accepts no responsibility for any printing errors. Specifications can be modified without prior notice, if technical or commercial reasons so require.
- The colours shown on this catalogue are only a reference and an illustration of the products finishing. The colours shown are not binding because brightness, contrast and colour balance may vary due to the printing process.
- Colours may vary due to raw-material suppliers' changes and some differences may occur in tonal range.
- Due to its natural origin, wood-based products will always present natural imperfections inherent to the organic nature. And for similar reasons, they will also present traces of old-age in the course of time.
- Wood and Fabric products are highly susceptible to change its appearance with humidity and temperature. Close attention must be paid to the storage conditions and the acclimatization before, during and after the installation.
- Typical Indoor Comfort Standards state a temperature range of 20°C - 27°C (68°F - 81°F), and a relative humidity of less than 60%. These would be considered as normal operational levels of JOCAVI® products' range.
- Despite all the standard sizes of all products, this model can be customised upon previous consultation. Sizes may vary slightly due to their production method and some inherent raw-materials characteristics.



CONVEXABSORBER®

ABSORBENT PANEL



Image of 180x114cm model Ref.:CON180 (on the left) and 180x114cm models applied (ambient image).

DESCRIPTION

The CONVEXABSORBER® is an absorbent panel which is efficient at absorbing low and medium frequencies. It was designed to be installed on ceilings and walls. It is manufactured by combining two techniques: a box tuned to 200 Hz, which is efficient at low and mid-low frequencies, and a mathematically studied absorbent labyrinth, which provides this product with an excellent performance in absorbing sound. Given its characteristics, this panel balances reverberation times and echoes in large-sized rooms, auditoriums, etc.. Because of its large and convex shape, it also is a diffuser with a large dispersion surface. When the areas so require, these panels can be installed alternately at 90° angles, the dispersion thus being on two plans. The CONVEXABSORBER® panel was designed and tested in order to guarantee its high performance in controlling sound energy, by reducing resonances and reflections. It has a wide range of applications.

FEATURES

- Uses 65% of recycled materials.
- NRC: **0.81/m²**.
- Fire-resistance: Euroclass B (similar to old M1).
- To apply in large rooms.
- Installation: accessories included.

TECHNICAL DRAWINGS

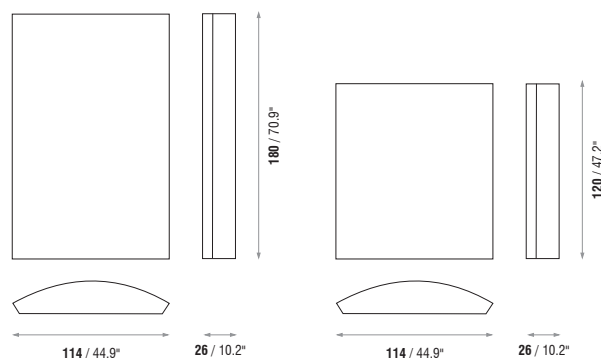

MODELS AND SIZES

MODELS	HEIGHT	WIDTH	DEPTH	WEIGHT
CON180	180 cm (70.9 in)	114 cm (44.9 in)	26 cm (10.2 in)	35.1 Kg (77.38 lbs)
CON120	120 cm (47.2 in)	114 cm (44.9 in)	26 cm (10.2 in)	23.4 Kg (51.59 lbs)

ABSORPTION COEFFICIENT

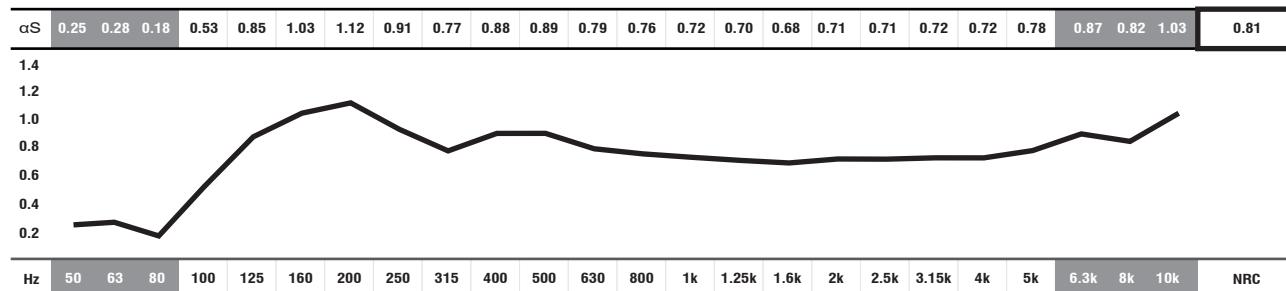

■ ABSORPTION COEFFICIENT: Values in accordance with the standards: EN 20654, ASTM C423 and EN 11654.

■ Values [<100Hz and > 5K] are Non Standard Values.

STANDARD FABRIC COLOURS



IMPORTANT NOTICES

- JOCAVI® accepts no responsibility for any printing errors. Specifications can be modified without prior notice, if technical or commercial reasons so require.
- RAL® is an international independent colour standard system partner for industry, trade, architecture and design. Should be consulted before placing any order.
- The colours shown on this catalogue are only a reference and an illustration of the products finishing. The colours shown are not binding because brightness, contrast and colour balance may vary due to the printing process.
- Colours may vary due to raw-material suppliers' changes and some differences may occur in tonal range.
- Wood and Fabric products are highly susceptible to change its appearance with humidity and temperature. Close attention must be paid to the storage conditions and the acclimatization before, during and after the installation.
- Typical Indoor Comfort Standards state a temperature range of 20°C - 27°C (68°F - 81°F), and a relative humidity of less than 60%. These would be considered as normal operational levels of JOCAVI® products' range.
- Despite all the standard sizes of all products, this model can be customised upon previous consultation. Sizes may vary slightly due to their production method and some inherent raw-materials characteristics.



Image of 60x60cm models Ref.:EBY060 (on the left) and Ref.:EBY120 (ambient image).

DESCRIPTION

The EBONY® is a medium-frequency acoustic absorption panel. Its convex shape helps to reduce the first convergent angles in rooms. The front part of this model consists of a polyurethane resonant membrane in an air-box. Three other raw-materials with different properties are used inside it.

In spite of its small size, the EBONY® also has a reasonable absorption coefficient at low frequencies.

Due to its shape, the absorption panel EBONY® combines to perfection, technically and aesthetically, with the ATP® diffuser model, the IVORY®.

This product is meant to be mounted on walls and ceilings and its low weight makes it particularly suitable for ceilings.

The EBONY® is an absorbent panel which is widely efficient in the mid and mid-low range of the sound spectrum.

TECHNICAL DRAWINGS

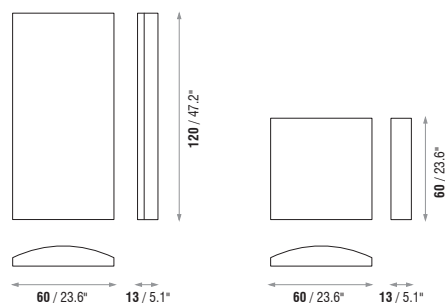

FEATURES

- Uses 55% of recycled materials.
- NRC: **0.64/m²**.
- 100% recyclable.
- Fire-resistance: Euroclass B (similar to old M1).
- Installation: accessories included.

MODELS AND SIZES

MODELS	HEIGHT	WIDTH	DEPTH	WEIGHT
EBY120	120 cm (47.2 in)	60 cm (23.6 in)	13 cm (5.1 in)	7.6 Kg (16.76 lbs)
EBY060	60 cm (23.6 in)	60 cm (23.6 in)	13 cm (5.1 in)	3.8 Kg (8.38 lbs)

ABSORPTION COEFFICIENT

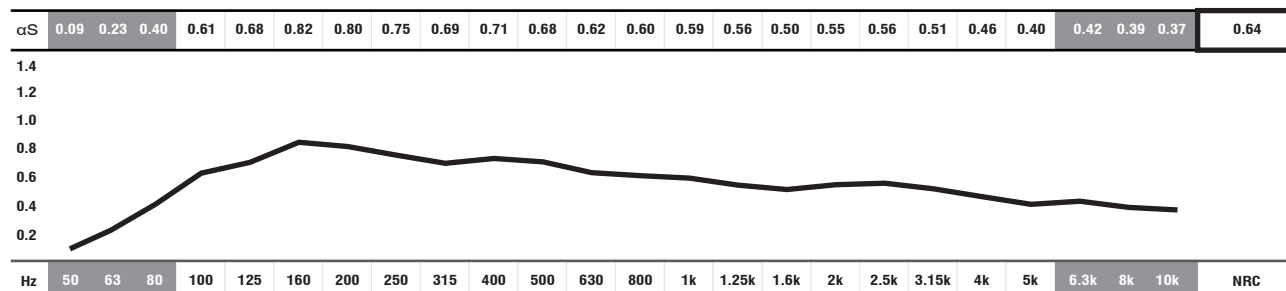

■ ABSORPTION COEFFICIENT: Values in accordance with the standards: EN 20654, ASTM C423 and EN 11654.

■ Values [$<100\text{Hz}$ and $>5\text{K}$] are Non Standard Values.

STANDARD FABRIC COLOURS

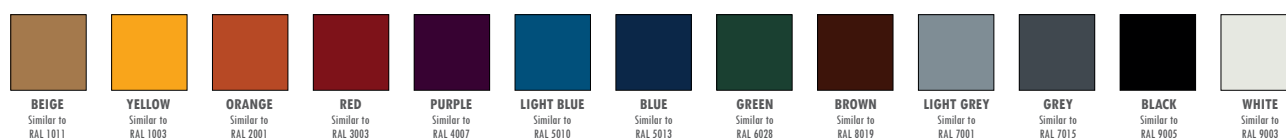

IMPORTANT NOTICES

- JOCAVI® accepts no responsibility for any printing errors. Specifications can be modified without prior notice, if technical or commercial reasons so require.
- RAL® is an international independent colour standard system partner for industry, trade, architecture and design. Should be consulted before placing any order.
- The colours shown on this catalogue are only a reference and an illustration of the products finishing. The colours shown are not binding because brightness, contrast and colour balance may vary due to the printing process.
- Colours may vary due to raw-material suppliers' changes and some differences may occur in tonal range.
- Wood and Fabric products are highly susceptible to change its appearance with humidity and temperature. Close attention must be paid to the storage conditions and the acclimatization before, during and after the installation.
- Typical Indoor Comfort Standards state a temperature range of 20°C - 27°C (68°F - 81°F), and a relative humidity of less than 60%. These would be considered as normal operational levels of JOCAVI® products' range.
- Despite all the standard sizes of all products, this model can be customised upon previous consultation. Sizes may vary slightly due to their production method and some inherent raw-materials characteristics.



LEAKY FM[®]

ABSORBENT PANEL



Image of 60x60cm model Ref.:LFM060 (on the left) and Ref.:LFM120 (ambient image).

DESCRIPTION

JOCAVI[®] has developed the LeakyFM[®] as an additional option within the range of its absorption panels. It is mainly meant for radio and television studios, as well as broadcasting and voice-over rooms and auditoriums.

The typical voice-off loudness requires an adequate planning of the room's acoustics in order to provide good sound reception. JOCAVI[®] has come up with this product which has a good absorption coefficient at 500Hz, exactly within the mid-range of the human voice, thus creating a sort of a loudness effect in rooms that radio speakers and professionals much appreciate.

Although it is different in aesthetic terms, the LeakyFM[®] is attractive and has a pleasant design. This panel provides the customer with six options to project his space.

The LeakyFM[®] is available in three different aesthetics with equally different acoustic features.

It is built by combining absorbent raw materials made from natural fibres and recycled synthetic fibres.

FEATURES

- Uses 80% of recycled materials.
- NRC: (LFM 0.86/m²), (LFMB 0.82/m²), (LFMC 0.80/m²) (LFM3D 0.74/m²), (LFMT 0.93/m²), (LFMD 0.93/m²).
- Fire-resistance: Euroclass B-s2,d0 (similar to old M1).
- 100% recyclable.
- Installation: accessories included.
- Other sizes are available on demand.

TECHNICAL DRAWINGS

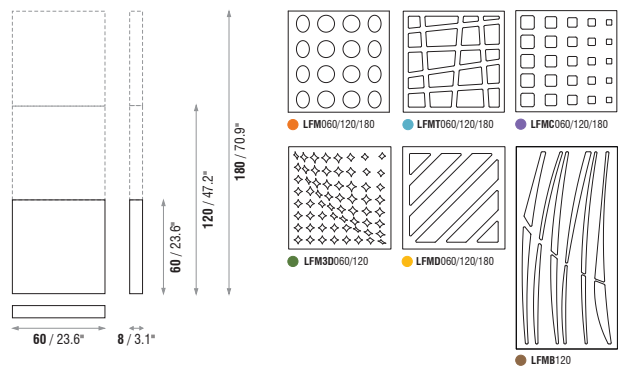

MODELS AND SIZES

MODELS	HEIGHT	WIDTH	DEPTH	WEIGHT
LFM180	180 cm (70.9 in)	60 cm (23.6 in)	8 cm (3.1")	18.9 Kg (41.67 lbs)
LFM120	120 cm (47.2 in)	60 cm (23.6 in)	8 cm (3.1")	12.6 Kg (27.78 lbs)
LFM060	60 cm (23.6 in)	60 cm (23.6 in)	8 cm (3.1")	6.3 Kg (13.89 lbs)

- LFM060/120/180
- LFMC060/120/180
- LFMD060/120/180
- LFMB120
- LFM3D060/120
- LFMT060/120/180

ABSORPTION COEFFICIENT

• αS	0.04	0.06	0.09	0.16	0.25	0.38	0.58	0.81	1.01	1.09	1.15	1.12	0.96	0.87	0.80	0.67	0.62	0.54	0.52	0.55	0.63	0.77	0.81	0.80	0.86
• αS	0.05	0.06	0.07	0.15	0.23	0.34	0.52	0.67	0.85	0.94	1.00	1.01	1.04	0.99	0.90	0.77	0.64	0.55	0.48	0.48	0.55	0.59	0.64	0.62	0.82
• αS	0.05	0.06	0.07	0.14	0.23	0.30	0.49	0.71	0.81	0.88	0.92	0.95	0.97	0.91	0.82	0.69	0.66	0.54	0.48	0.50	0.58	0.59	0.65	0.64	0.80
• αS	0.03	0.05	0.08	0.14	0.20	0.27	0.44	0.66	0.78	0.86	0.89	0.92	0.88	0.83	0.71	0.63	0.56	0.50	0.43	0.45	0.46	0.48	0.51	0.49	0.74
• αS	0.04	0.08	0.15	0.26	0.38	0.55	0.74	0.92	1.06	1.16	1.13	1.08	0.97	0.93	0.84	0.79	0.75	0.69	0.68	0.71	0.75	0.83	0.84	0.84	0.93
• αS	0.04	0.08	0.14	0.25	0.36	0.52	0.73	0.91	1.04	1.09	1.12	1.05	0.96	0.92	0.82	0.76	0.75	0.68	0.65	0.69	0.74	0.82	0.84	0.84	0.93

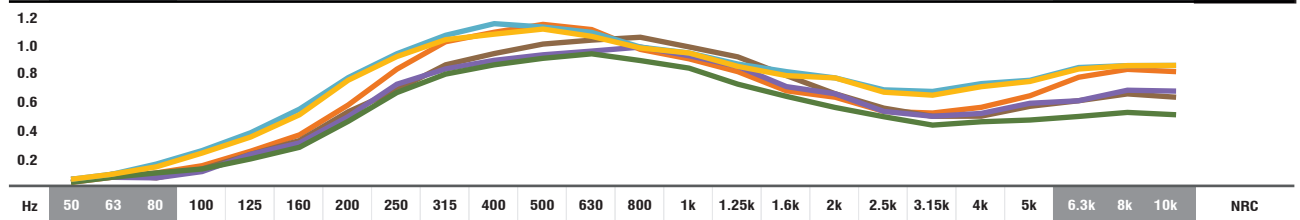

• ABSORPTION COEFFICIENT: Values in accordance with the standards: EN 20654, ASTM C423 and EN 11654. ■ Values [$<100\text{Hz}$ and $>5\text{K}$] are Non Standard Values.

ENGINEERED COLOURED WOOD COLOURS

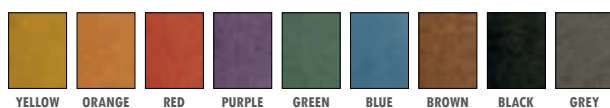

WOOD VENEER FINISHINGS



IMPORTANT NOTICES

- JOCAVI[®] accepts no responsibility for any printing errors. Specifications can be modified without prior notice, if technical or commercial reasons so require.
- The colours shown on this catalogue are only a reference and an illustration of the products finishing. The colours are not binding because brightness, contrast and colour balance may vary due to the printing process.
- Colours may vary due to raw-material suppliers' changes and some differences may occur in tonal range.
- Due to its natural origin, wood-based products will always present natural imperfections inherent to the organic nature. And for similar reasons, they will also present traces of old-age in the course of time.
- Wood and Fabric products are highly susceptible to change its appearance with humidity and temperature. Close attention must be paid to the storage conditions and the acclimatization before, during and after the installation.
- Typical Indoor Comfort Standards state a temperature range of 20°C - 27°C (68°F - 81°F), and a relative humidity of less than 60%. These would be considered as normal operational levels of JOCAVI[®] products' range.
- Despite all the standard sizes of all products, this model can be customised upon previous consultation. Sizes may vary slightly due to their production method and some inherent raw-materials characteristics.



J MORSE®
ABSORBENT PANEL



Image of 60x60cm model Ref.: JCV060 (on the left) and detail image on the right

DESCRIPTION

JMorse® is a very attractive acoustic treatment panel to acoustically decorate room environments. The appearance of this model combines the hardness of the colored HMDF of the case with the PET's spherical shapes in low and high relief. This model has a small resonance box that allows a very interesting absorption in the mid/low range of the sound spectrum. The relief of these models is given by PET material which is manufactured with natural fibers using wasted recycled polyester ones in a hot-pressing process to agglomerate the thickness, shape and density. This raw material contributes to a healthy indoor air quality and it is rated as a non-toxic solution that acts as an excellent fire retardant, also actively inhibiting the growth of mildew, mold, and bacteria. This model can be supplied in small sizes for studios or in large sizes for large rooms and public spaces, offering two alternatives: the convex balls in high relief or the concave balls in low relief. JMorse was developed as part of the interior design, adequate for studios and comfortable workplaces, as well as public spaces dealing with the acoustic environment and improving sound intelligibility within the room. It is suitable for application on walls and ceilings in various types of environments; public spaces, workspaces, hotels, multi-function halls, conference rooms and gyms, where acoustic and aesthetic performance appeal is important within a controlled budget.

FEATURES

- Raw materials: PET Natural recycled polyester fibre | HMDF Coloured wood veneer.
- NRC: **0.80/m²**
- Dimensions: 600x600mm | 1200x 600mm | 1800x1200mm.
- Fire-resistance: Euroclass B-s2, d0 or M1 (Fr).
- Very easy to install including mounting accessories.
- 100% recyclable.

TECHNICAL DRAWINGS

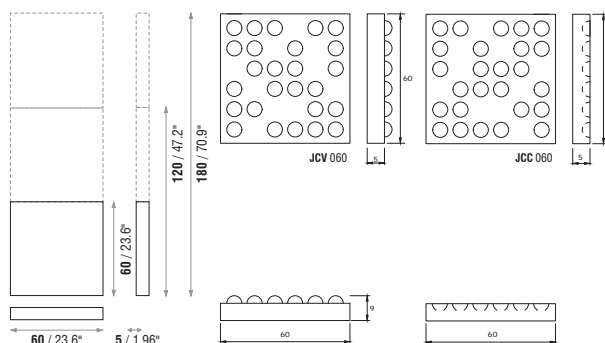

MODELS AND SIZES

MODELS	HEIGHT	WIDTH	DEPTH	WEIGHT
JCC 180 / JCV 180	180 cm (70.9 in)	120 cm (47.2 in)	5/9 cm (3.93" / 3.54")	18.9 Kg (41.67 lbs)
JCC 120 / JCV 120	120 cm (47.2 in)	60 cm (23.6 in)	5/9 cm (3.93" / 3.54")	12.6 Kg (27.78 lbs)
JCC 060 / JCV 060	60 cm (23.6 in)	60 cm (23.6 in)	5/9 cm (3.93" / 3.54")	6.3 Kg (13.89 lbs)

STANDARD PET COLOURS

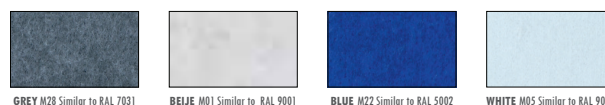

ABSORPTION COEFFICIENT

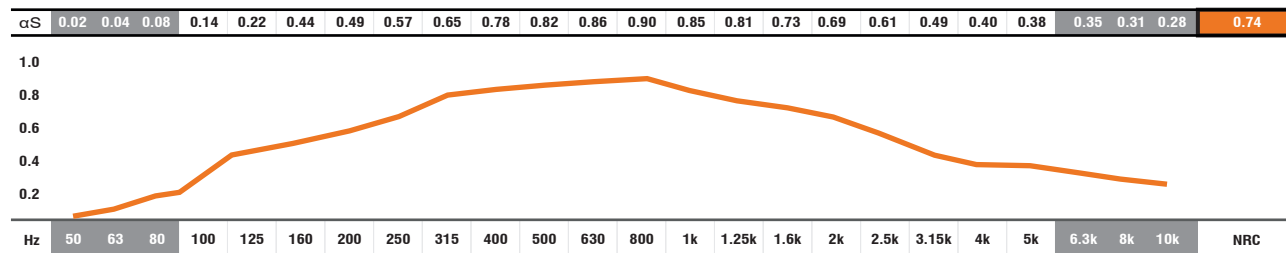

• ABSORPTION COEFFICIENT: Values in accordance with the standards: EN 20654, ASTM C423 and EN 11654.

■ Values [$<100\text{Hz}$ and $>5\text{K}$] are Non Standard Values.

ENGINEERED COLOURED WOOD COLOURS

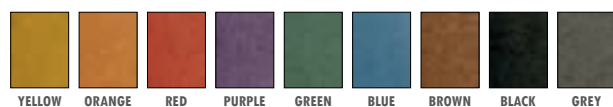

WOOD VENEER FINISHINGS



IMPORTANT NOTICES

- JOCAVI® accepts no responsibility for any printing errors. Specifications can be modified without prior notice, if technical or commercial reasons so require.
- The colours shown on this catalogue are only a reference and an illustration of the products finishing. The colours shown are not binding because brightness, contrast and colour balance may vary due to the printing process.
- Colours may vary due to raw-material suppliers' changes and some differences may occur in tonal range.
- Due to its natural origin, wood-based products will always present natural imperfections inherent to the organic nature. And for similar reasons, they will also present traces of old-age in the course of time.
- Wood and Fabric products are highly susceptible to change its appearance with humidity and temperature. Close attention must be paid to the storage conditions and the acclimatization before, during and after the installation.
- Typical Indoor Comfort Standards state a temperature range of 20°C - 27°C (68°F - 81°F), and a relative humidity of less than 60%. These would be considered as normal operational levels of JOCAVI® products' range.
- Despite all the standard sizes of all products, this model can be customised upon previous consultation. Sizes may vary slightly due to their production method and some inherent raw-materials characteristics.



LIGHTWALLTRAP® / CLOUD

ABSORBENT PANEL



Image of 180x90cm, of the new 90x90cm cloud shape, the 90cm circular panel and 90x30cm model Ref.:LIG180, LIGC090, LIGR090 and LIG030 (on the left) and Ref.:LIGR090 model applied (ambient image).

DESCRIPTION

This panel is related to the MELLOWALLTRAP® and the WALLTRAP® panels, as it is an absorption panel to be applied on walls and ceilings that predominantly absorbs in the mid-range of the sound spectrum.

The similarities end there given that its size, technical characteristics and respective type of mounting are quite different.

It is an acoustic panel that absorbs medium frequencies and has been developed to be used in various sized rooms.

This product is manufactured with raw materials of different mass and density which are duly coupled in order to increase its absorption coefficient as much as possible.

Several panels can be assembled together with surprising results. As regards its size, it is one of the most effective panels available in the market.

TECHNICAL DRAWINGS

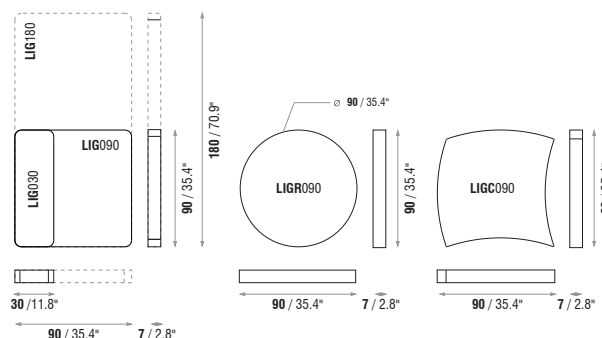

FEATURES

- Uses 65% of recycled materials.
- NRC: **0.73/m²**.
- Fire-resistance: Euroclass B (similar to old M1).
- 100% recyclable.
- Installation: accessories included.
- Other sizes available on demand.
- **MOTIF®** finishing available in all models **except in LIGR90/120 and LIGC090 models**.

MODELS AND SIZES

MODELS	HEIGHT	WIDTH	DEPTH	WEIGHT
LIG180	180 cm (70.9 in)	90 cm (35.4 in)	7 cm (2.8 in)	20.3 Kg (44.75 lbs)
LIG090	90 cm (35.4 in)	90 cm (35.4 in)	7 cm (2.8 in)	11.2 Kg (24.69 lbs)
LIG030	30 cm (11.8 in)	90 cm (35.4 in)	7 cm (2.8 in)	3.8 Kg (8.38 lbs)
LIGR120	-	ø120 cm (47.2 in)	7 cm (2.8 in)	11.8 Kg (26.01 lbs)
LIGR090	-	ø90 cm (35.4 in)	7 cm (2.8 in)	8.7 Kg (19.18 lbs)
LIGC090	90 cm (35.4 in)	90 cm (35.4 in)	7 cm (2.8 in)	9.5 Kg (20.94 lbs)

ABSORPTION COEFFICIENT

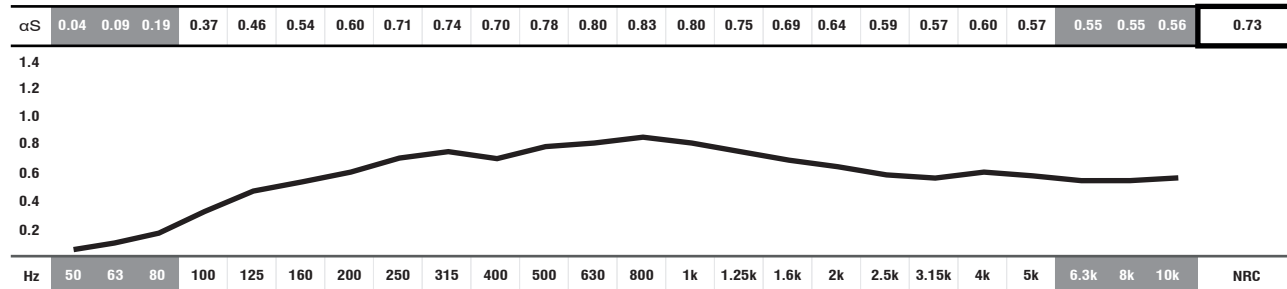

■ ABSORPTION COEFFICIENT: Values in accordance with the standards: EN 20654, ASTM C423 and EN 11654.

■ Values [$<100\text{Hz}$ and $>5\text{K}$] are Non Standard Values.

STANDARD FABRIC COLOURS



IMPORTANT NOTICES

- JOCAVI® accepts no responsibility for any printing errors. Specifications can be modified without prior notice, if technical or commercial reasons so require.
- RAL® is an international independent colour standard system partner for industry, trade, architecture and design. Should be consulted before placing any order.
- The colours shown on this catalogue are only a reference and an illustration of the products finishing. The colours shown are not binding because brightness, contrast and colour balance may vary due to the printing process.
- Colours may vary due to raw-material suppliers' changes and some differences may occur in tonal range.
- Wood and Fabric products are highly susceptible to change its appearance with humidity and temperature. Close attention must be paid to the storage conditions and the acclimatization before, during and after the installation.
- Typical Indoor Comfort Standards state a temperature range of 20°C - 27°C (68°F - 81°F), and a relative humidity of less than 60%. These would be considered as normal operational levels of JOCAVI® products' range.
- Despite all the standard sizes of all products, this model can be customised upon previous consultation. Sizes may vary slightly due to their production method and some inherent raw-materials characteristics.



Image of 180x60cm, 120x60cm and 60x60cm models Ref.:MEL180, MEL120 and MEL060 (on the left) and three Ref.:MEL120 models applied (ambient image) with MOTIF® finishing.

DESCRIPTION

Auditoriums, music audition rooms, studios, practice rooms, etc., need an efficient surface that is efficient at absorbing sound waves within the largest possible range of frequencies.

The MELLOWALLTRAP® is an absorbent panel meant to be installed on walls and ceilings. This product is particularly important for absorbing the mid and mid-high range of the sound spectrum. This panel excels due to its high performance, small size and low weight.

Although it is manufactured with the best absorbent materials of medium frequencies, JOCAVI® added to those materials a mathematically-studied form of incisions in order to increase and improve its results.

The MELLOWALLTRAP®'s shape was designed to absorb the incident sound on walls and ceilings, thus reducing the reflected energy at the hearing point and eliminating, to some extent, the room effect.

It is an absorption panel which is highly efficient in the mid-range of the sound spectrum.

FEATURES

- Uses 75% of recycled materials.
- NRC: **0.95/m²**.
- Fire-resistance: Euroclass B (similar to old M1).
- To apply in large rooms
- 100% recyclable.
- Installation: accessories included.
- Other sizes are available on demand.

TECHNICAL DRAWINGS

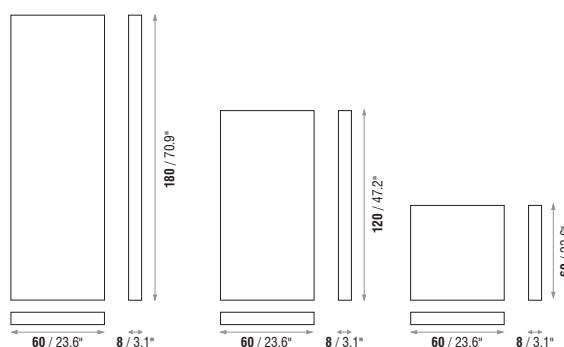

MODELS AND SIZES

MODELS	HEIGHT	WIDTH	DEPTH	WEIGHT
MEL180	180 cm (70.9 in)	60 cm (23.6 in)	8 cm (3.1 in)	12 Kg (26.46 lbs)
MEL120	120 cm (47.2 in)	60 cm (23.6 in)	8 cm (3.1 in)	8 Kg (17.64 lbs)
MEL060	60 cm (23.6 in)	60 cm (23.6 in)	8 cm (3.1 in)	4 Kg (8.82 lbs)

ABSORPTION COEFFICIENT

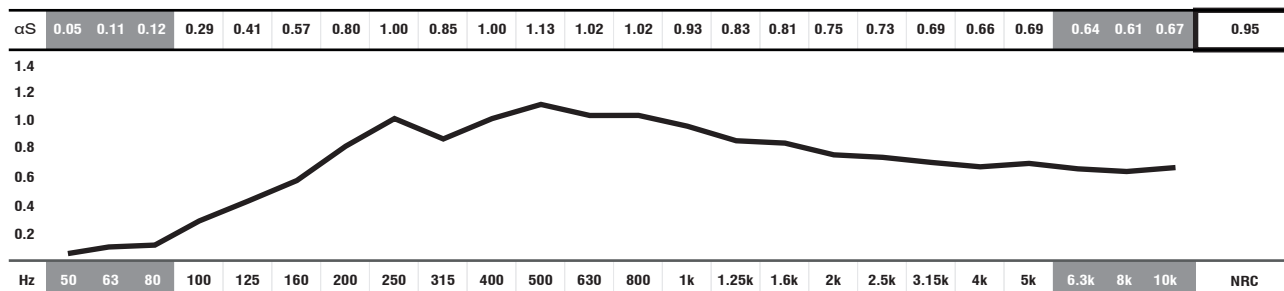

■ ABSORPTION COEFFICIENT: Values in accordance with the standards: EN 20654, ASTM C423 and EN 11654.

■ Values [< 100 Hz and > 5 K] are Non Standard Values.

STANDARD FABRIC COLOURS



IMPORTANT NOTICES

- JOCAVI® accepts no responsibility for any printing errors. Specifications can be modified without prior notice, if technical or commercial reasons so require.
- RAL® is an international independent colour standard system partner for industry, trade, architecture and design. Should be consulted before placing any order.
- The colours shown on this catalogue are only a reference and an illustration of the products finishing. The colours shown are not binding because brightness, contrast and colour balance may vary due to the printing process.
- Colours may vary due to raw-material suppliers' changes and some differences may occur in tonal range.
- Wood and Fabric products are highly susceptible to change its appearance with humidity and temperature. Close attention must be paid to the storage conditions and the acclimatization before, during and after the installation.
- Typical Indoor Comfort Standards state a temperature range of 20°C - 27°C (68°F - 81°F), and a relative humidity of less than 60%. These would be considered as normal operational levels of JOCAVI® products' range.
- Despite all the standard sizes of all products, this model can be customised upon previous consultation. Sizes may vary slightly due to their production method and some inherent raw-materials characteristics.



MELLOWCLOUD® ABS

SUSPENDED ABSORBENT PANEL

THREE
UPDATED
SHAPES



Image of Mellowcloud® ABS model Ref.:MELABS applied (ambient image).

DESCRIPTION

The MELLOWCLOUD® ABS is a One Dimensional Curved Shaped Absorbent Acoustic panel for the acoustic construction industry. This model has been designed to provide almost infinite possibilities free combinations for ceiling applications.

The MELLOWCLOUD® ABS is a mid-range frequency absorption acoustic panel, consisting of a rigid EPS body with porous absorbing acoustic foam coated with fabric, evolves and meets the aesthetic challenge while offering as well an optimal One Dimensional Sound Diffusion. Shaping and curving the surfaces can improve the coverage of the sound scattered diffusion energy throughout the room.

This model can be compared and combined with MELLOWCLOUD® DIF, which have the same ideology.

This is a product to be suspended in ceilings or on metal grids. The MELLOWCLOUD® ABS improves soundproofing and reverberation time levels for all types of environments, it is mainly installed in large areas of application such as auditoriums, conference rooms, multipurpose rooms, hospitals, clinics, offices, shops, radio stations restaurants, bars, food courts and airports, places where airborne noise reduction is imperative.

TECHNICAL DRAWINGS

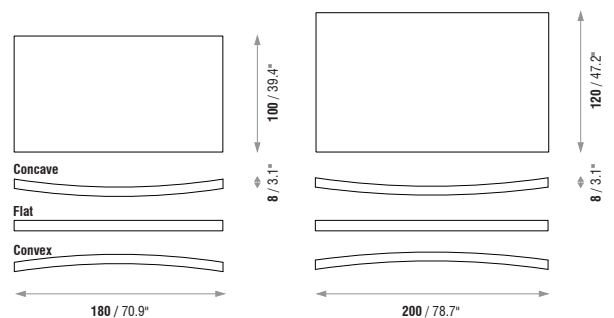

FEATURES

- JOCAVI® fabric finish.
- NRC : **0.89/m²**
- Fire-resistance: Euroclass B (similar to old M1).
- Optimized shape, arraying and positioning insures uniform coverage.
- Panels can be used independently or tiled side to side and front to back.
- Suspended using Integrated mounting hardware and cable system (only four supports/hangers by each panel).
- Size max: 2,00mt x 1,20mt (several modules can be interconnected).
- Very lightweight (5 Kg/m² - 80 mm thick panel).

MODELS AND SIZES

MODELS	HEIGHT	WIDTH	DEPTH	WEIGHT
MCDABS200	200 cm (78.7 in)	120 cm (47.2 in)	8 cm (3.1 in)	14 Kg (30.86 lbs)
MCDABS180	180 cm (70.9 in)	100 cm (39.4 in)	8 cm (3.1 in)	9 Kg (19.84 lbs)

DIFFUSION - ABSORPTION COEFFICIENT

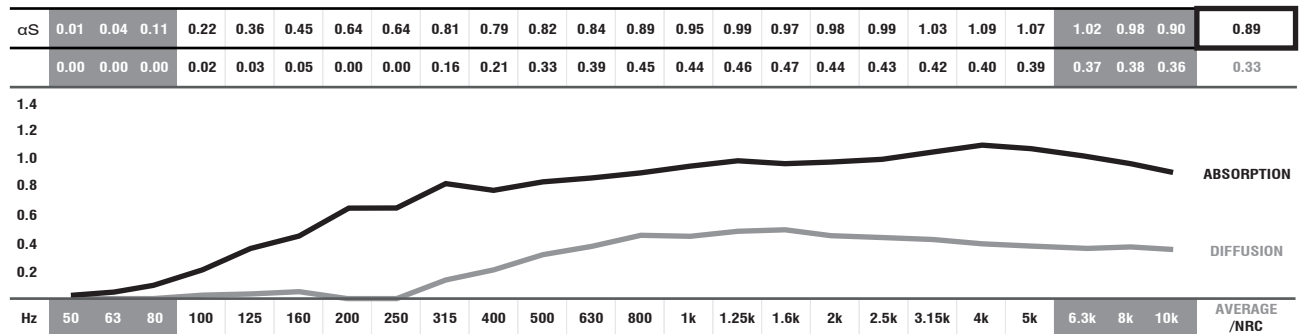

■ ABSORPTION COEFFICIENT: Values in accordance with the standards: EN 20654, ASTM C423 and EN 11654. ■ Values [$<100\text{Hz}$ and $>5\text{K}$] are Non Standard Values.
 ■ DIFFUSION COEFFICIENT: These values were obtained by mathematical calculations and tests carried out in our laboratory.

STANDARD FABRIC COLOURS

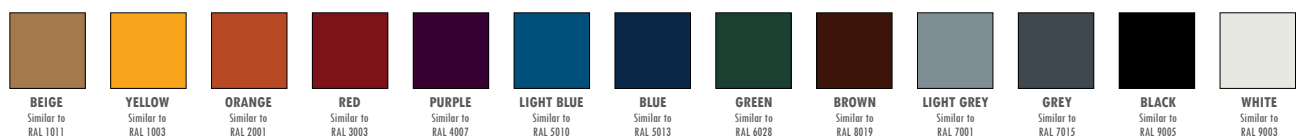

IMPORTANT NOTICES

- JOCAVI® accepts no responsibility for any printing errors. Specifications can be modified without prior notice, if technical or commercial reasons so require.
- RAL® is an international independent colour standard system partner for industry, trade, architecture and design. Should be consulted before placing any order.
- The colours shown on this catalogue are only a reference and an illustration of the products finishing. The colours shown are not binding because brightness, contrast and colour balance may vary due to the printing process.
- Colours may vary due to raw-material suppliers' changes and some differences may occur in tonal range.
- Wood and Fabric products are highly susceptible to change its appearance with humidity and temperature. Close attention must be paid to the storage conditions and the acclimatization before, during and after the installation.
- Typical Indoor Comfort Standards state a temperature range of 20°C - 27°C (68°F - 81°F), and a relative humidity of less than 60%. These would be considered as normal operational levels of JOCAVI® products' range.
- Despite all the standard sizes of all products, this model can be customised upon previous consultation. Sizes may vary slightly due to their production method and some inherent raw-materials characteristics.



MELLOWAFFLE®

ABSORBENT PANEL

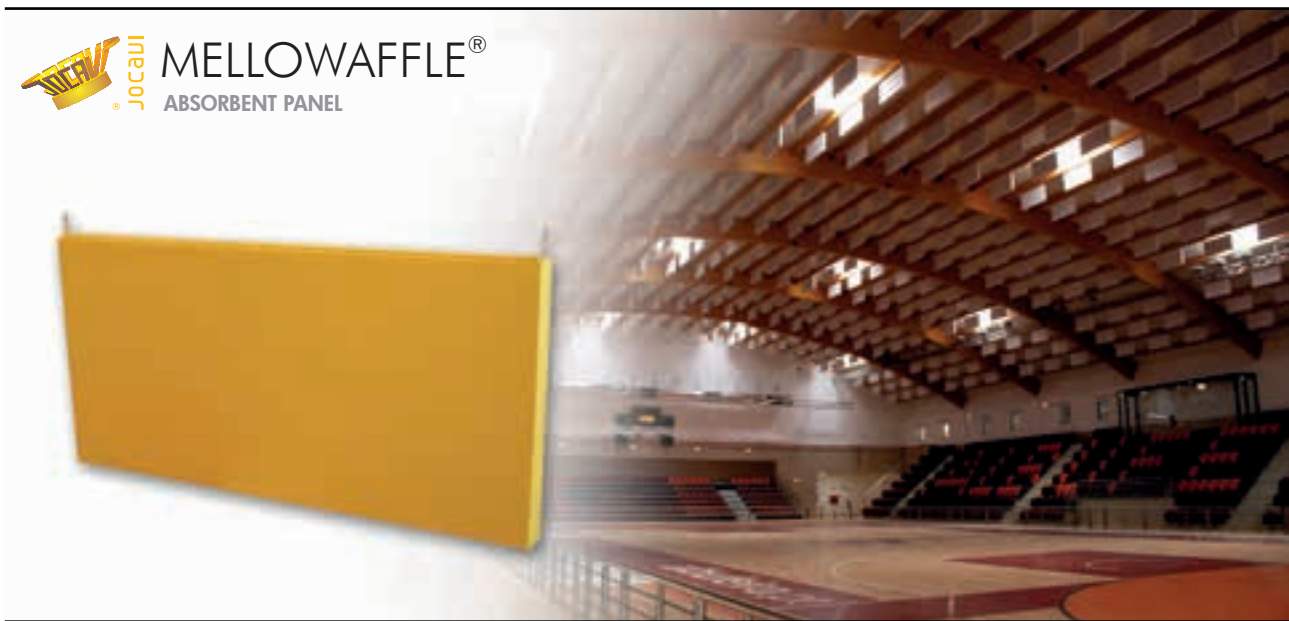

Image of 137x62cm model Ref.:MEW137 (on the left) and Ref.:MEW137 model applied (ambient image).

DESCRIPTION

JOCAVI's MELLOWAFFLE® has been designed to be suspended in large areas in order to eliminate echoes and reduce the reverberation time. It controls and reduces problems caused by airborne noise. This is the product recommended for large volume rooms: big studios, gymnasiums, pavilions, swimming-pools, factories, warehouses, commercial and industrial buildings, machine or engine rooms where airborne noise is a concern. The MELLOWAFFLE® has two absorbent sides which are different from each other. Due to the large exposed area, its absorption coefficient is quite high. It is installed by suspension from a steel cable or is directly fixed to the building structure or masonry with its appropriate accessories. Besides the mentioned acoustic characteristics, this product is highly resistant to abrasion and fire (old class M1). When set on fire, it releases a very low quantity of smoke. It has a long durability. It is cleaned and maintained through suction. This product has relatively good resistance to humidity and is, therefore, also recommended for swimming-pools. This is an excellent and much better alternative to the application of acoustic foams.

FEATURES

- Uses 75% of recycled materials.
- NRC : **1.09/m²**.
- Fire-resistance: Euroclass B (similar to old M1).
- 100% recyclable.
- Installation: accessories included.

TECHNICAL DRAWINGS

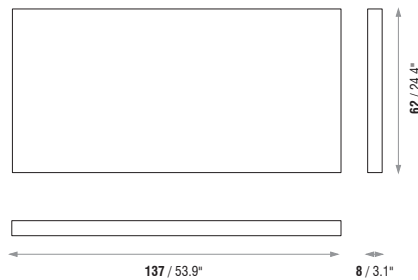

MODELS AND SIZES

MODELS	HEIGHT	WIDTH	DEPTH	WEIGHT
MEW137	137 cm (53.9 in)	62 cm (24.4 in)	8 cm (3.1 in)	3.4 Kg (3.4 lbs)

ABSORPTION COEFFICIENT

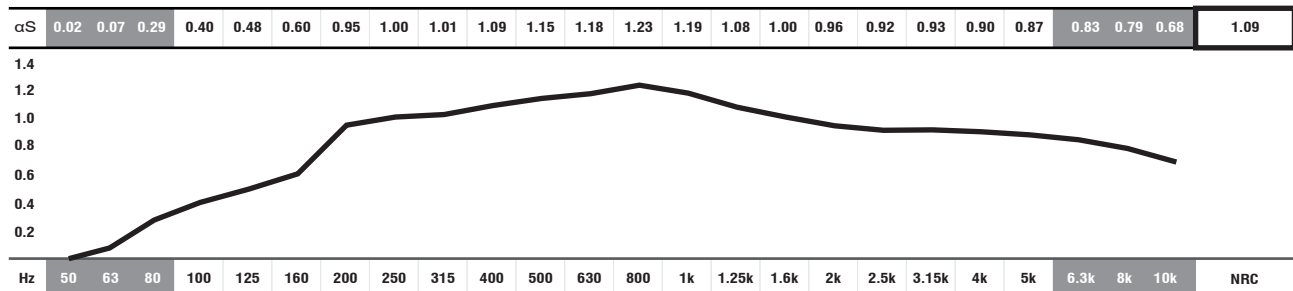

■ ABSORPTION COEFFICIENT: Values in accordance with the standards: EN 20654, ASTM C423 and EN 11654.

■ Values [< 100 Hz and > 5 K] are Non Standard Values.

STANDARD FABRIC COLOURS



IMPORTANT NOTICES

- JOCAVI® accepts no responsibility for any printing errors. Specifications can be modified without prior notice, if technical or commercial reasons so require.
- RAL® is an international independent colour standard system partner for industry, trade, architecture and design. Should be consulted before placing any order.
- The colours shown on this catalogue are only a reference and an illustration of the products finishing. The colours shown are not binding because brightness, contrast and colour balance may vary due to the printing process.
- Colours may vary due to raw-material suppliers' changes and some differences may occur in tonal range.
- Wood and Fabric products are highly susceptible to change its appearance with humidity and temperature. Close attention must be paid to the storage conditions and the acclimatization before, during and after the installation.
- Typical Indoor Comfort Standards state a temperature range of 20°C - 27°C (68°F - 81°F), and a relative humidity of less than 60%. These would be considered as normal operational levels of JOCAVI® products' range.
- Despite all the standard sizes of all products, this model can be customised upon previous consultation. Sizes may vary slightly due to their production method and some inherent raw-materials characteristics.



STAIDTREAT WBA®

ABSORBENT PANEL



Image of 60x60cm model Ref.:WBA060 (on the left) and 60x60cm models applied (ambient image).

DESCRIPTION

The STAIDTREAT WBA® is a medium-frequency absorbent panel which is meant to be placed on walls or normal ceilings.

This absorbent panel has been developed by combining an adequately shaped high density black HIPS box with a filling composed of an absorbent material that was exclusively manufactured for this panel in order to increase its sound absorption coefficient.

The outer finishing plate is made of a porous and permeable pressed mineral granulate, which is highly absorbent in the medium and high frequencies, thus making this panel very balanced as regards absorption/frequency.

It is also available with an high quality performance speaker. Its designed to aesthetically conceal acoustic treatment with speakers providing a good sound intelligibility, besides making technology imperceptible to eyesight. This system was essentially planned for 7.1 and 5.1 home-theatres surround systems, but it is also advisable for conference rooms, restaurants and bars, public spaces and for background music or speech purposes.

FEATURES

- Plate of pressed granulated minerals.
- NRC: **0.66/m²**.
- Fire-resistance: Euroclass A2-s2,d0 (similar to old M1).
- Made of recycled materials.
- Can be applied on walls and ceilings.
- Installation: Mounting Aluminium Bars NOT included.
- Available in 6 colours.

TECHNICAL DRAWINGS

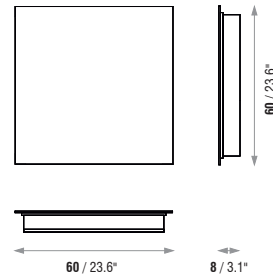

MODELS AND SIZES

MODELS	HEIGHT	WIDTH	DEPTH	WEIGHT
WBA060	60 cm (23.6 in)	60 cm (23.6 in)	8 cm (3.1 in)	3.9 Kg (8.60 lbs)
WBA060/SP	60 cm (23.6 in)	60 cm (23.6 in)	8 cm (3.1 in)	9.1 Kg (20.06 lbs)

ABSORPTION COEFFICIENT

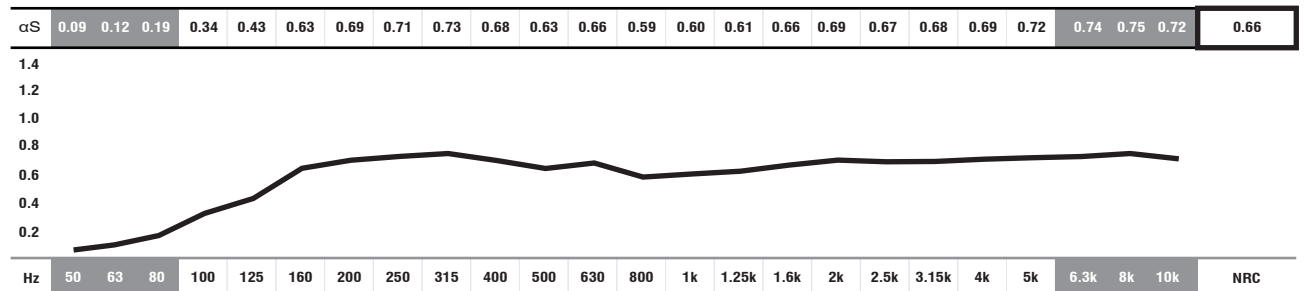

■ ABSORPTION COEFFICIENT: Values in accordance with the standards: EN 20654, ASTM C423 and EN 11654.

■ Values [<100Hz and > 5K] are Non Standard Values.

STANDARD MINERAL GRANULATED COLOURS

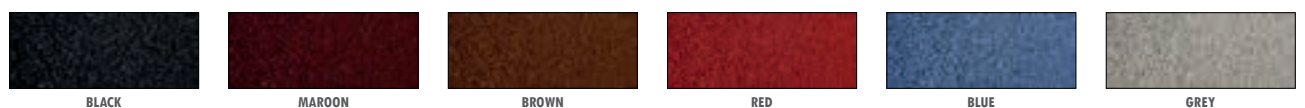

IMPORTANT NOTICES

- JOCAVI® accepts no responsibility for any printing errors. Specifications can be modified without prior notice, if technical or commercial reasons so require.
- RAL® is an international independent colour standard system partner for industry, trade, architecture and design. Should be consulted before placing any order.
- The colours shown on this catalogue are only a reference and an illustration of the products finishing. The colours shown are not binding because brightness, contrast and colour balance may vary due to the printing process.
- Colours may vary due to raw-material suppliers' changes and some differences may occur in tonal range.
- Typical Indoor Comfort Standards state a temperature range of 20°C - 27°C (68°F - 81°F), and a relative humidity of less than 60%. These would be considered as normal operational levels of JOCAVI® products' range.
- Sizes may vary slightly due to their production method and some inherent raw-materials characteristics.



WALLPERF® ABSORBENT PANEL

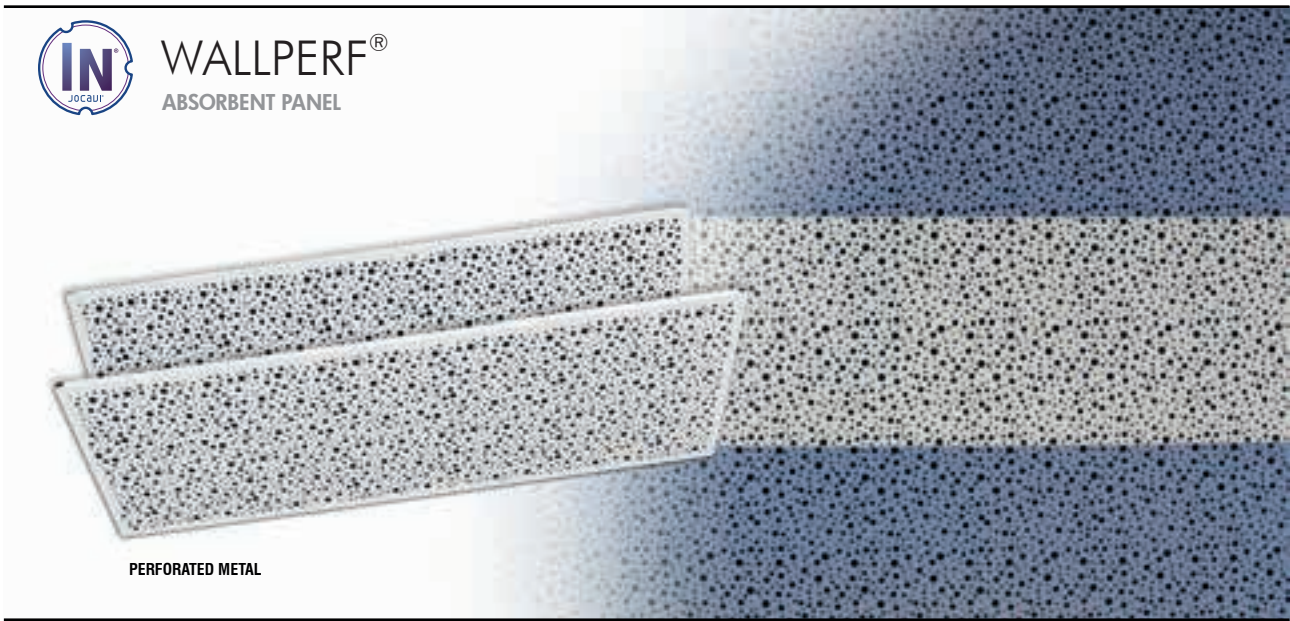

PERFORATED METAL

Image of 180x60cm model Ref.:MTPF025QC.

DESCRIPTION

WALLPERF® is an additional option within the IN® absorption panels range. It is mainly meant for stadiums, large halls, airports, subways and bus stations, as well as for industrial applications. It can also be applied in moist environments or outdoors.

This panel's structure is made on a perforated metal lacquered plate, which gives the product a good robustness; the interior is built by combining absorbent raw materials made from mineral and synthetic fibers.

The typical public and industrial spaces require an adequate planning of acoustics in order to provide good sound perception. The brand IN® has come up with this line of products which has a good absorption in the largest common noise range.

Although it is different in aesthetic terms, the WALLPERF® is attractive and has a pleasant design. The WALLPERF® is available in multiple colours with the same acoustic features. It is easy to install on the walls and ceilings with its own accessories.

TECHNICAL DRAWINGS

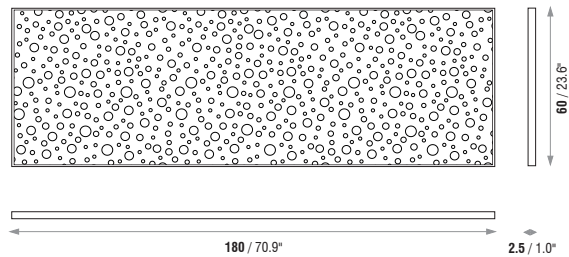

FEATURES

- Made of metal lacquered plate and different raw absorbent materials inside.
- NRC: **0.94/m²**.
- Fire-resistance: B-s1,d1 (similar to old M1).
- For ceiling and wall applications.
- Good robustness and airborne noise control.
- Suitable for areas with large space, subways, stadiums, airports and bus stations, pavilions as well as for public or industrial facilities.

MODELS AND SIZES

MODELS	HEIGHT	WIDTH	DEPTH	WEIGHT
MTPF025QC	180 cm (70.9 in)	60 cm (23.6 in)	2.5 cm (1.0 in)	3.3 Kg (7.28 lbs)

ABSORPTION COEFFICIENT

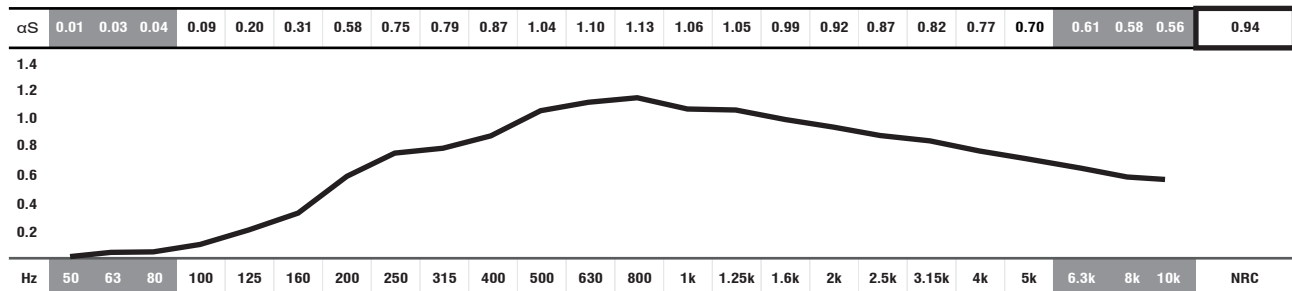

■ ABSORPTION COEFFICIENT: Values in accordance with the standards: EN 20654, ASTM C423 and EN 11654.

■ Values [$<100\text{Hz}$ and $>5\text{K}$] are Non Standard Values.

STANDARD COLOURS



IMPORTANT NOTICES

- JOCAVI® accepts no responsibility for any printing errors. Specifications can be modified without prior notice, if technical or commercial reasons so require.
- The colours shown on this catalogue are only a reference and an illustration of the products finishing. The colours shown are not binding because brightness, contrast and colour balance may vary due to the printing process.
- Colours may vary due to raw-material suppliers' changes and some differences may occur in tonal range. Close attention must be paid to the storage conditions and the acclimatization before, during and after the installation.
- Typical Indoor Comfort Standards state a temperature range of 20°C - 27°C (68°F - 81°F), and a relative humidity of less than 60%. These would be considered as normal operational levels of JOCAVI® products' range.
- Despite all the standard sizes of all products, this model can be customised upon previous consultation. Sizes may vary slightly due to their production method and some inherent raw-materials characteristics.



WOODFACE® ABSORBENT PANEL



Images of 120x60cm model Ret.:WP0616 and Ret.:WP1624 on the left and applied on the background image.

DESCRIPTION

WOODFACE® models are a wooden construction finishing material with acoustic absorbing properties. Following an ecological philosophy, this line of acoustic treatment materials was exclusively developed from recycled pressed wood fibers (HMDF) and coconut fibers, which are recycled materials.

This line of products provides a practical and efficient solution for acoustic treatment. It is composed of coconut fiber (as an energy absorbent material) and perforated panels made of pressed wood fiber (as a finishing surface). This compound, made of strictly 95% recycled materials, has an excellent technical performance. The coconut fiber is a natural, renewable and very light vegetal material. It has high porosity (95% of pores), which translates into an extremely high absorption of sound energy.

The good behavior of the recycled wood fibers, associated with the coconut fiber's micro-porous absorbent properties, makes it a natural first-class combination in terms of acoustic solutions.

The WOODFACE® is ideal for installing in auditoriums, conference rooms, sport pavilions, business and public spaces, restaurants and bars, etc... It can be installed with normal wood-strips or with the supplied aluminum interconnection bar.

FEATURES

- Standard perforations / wood finishings and coconut fibres (coir fibres).
- Uses 95% of recycled materials.
- NRC: **0.63/m²** (WP0616) and **0.64/m²** (WP1624).
- Fire-resistance: Wood Veneer Faced (or Engineered Coloured Fibre) Boards - Euroclass B-s2,d0 (similar to old M1), Coconut (Coir Fibre) - Euroclass E (similar to old M4).
- Installation: wood or metal bars.
- Others sizes are available on demand.

TECHNICAL DRAWINGS

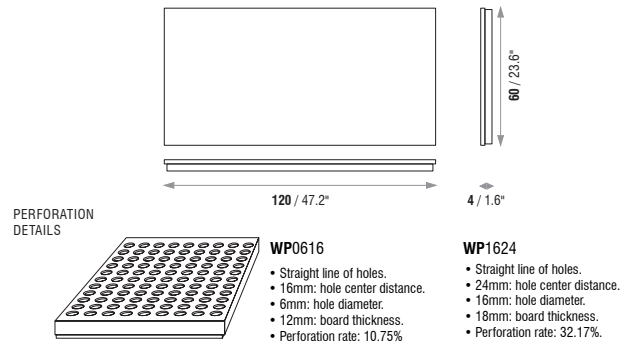

MODELS AND SIZES

MODELS	HEIGHT	WIDTH	DEPTH	WEIGHT
WP0616	120 cm (47.2 in)	60 cm (23.6 in)	4 cm (1.6 in)	2.5 Kg (5.51 lbs)
WP1624	120 cm (47.2 in)	60 cm (23.6 in)	4 cm (1.6 in)	2.5 Kg (5.51 lbs)

OTHER SIZES AVAILABLE UNDER CONSULTING

ABSORPTION COEFFICIENT

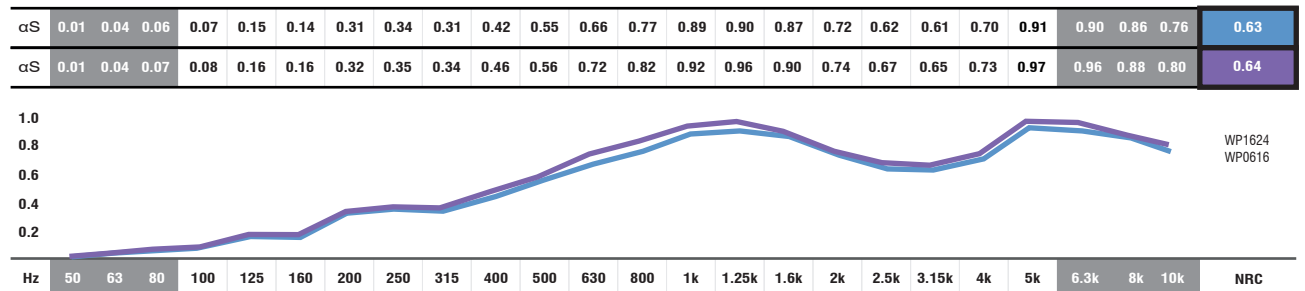

■ ABSORPTION COEFFICIENT: Values in accordance with the standards: EN 20654, ASTM C423 and EN 11654.

■ Values [$<100\text{Hz}$ and $>5\text{K}$] are Non Standard Values.

WOOD VENEER FINISHINGS



IMPORTANT NOTICES

- JOCAVI® accepts no responsibility for any printing errors. Specifications can be modified without prior notice, if technical or commercial reasons so require.
- The colours shown on this catalogue are only a reference and an illustration of the products finishing. The colours shown are not binding because brightness, contrast and colour balance may vary due to the printing process.
- Colours may vary due to raw-material suppliers' changes and some differences may occur in tonal range.
- Due to its natural origin, wood-based products will always present natural imperfections inherent to the organic nature. And for similar reasons, they will also present traces of old-age in the course of time.
- Wood and Fabric products are highly susceptible to change its appearance with humidity and temperature. Close attention must be paid to the storage conditions and the acclimatization before, during and after the installation.
- Typical Indoor Comfort Standards state a temperature range of 20°C - 27°C (68°F - 81°F), and a relative humidity of less than 60%. These would be considered as normal operational levels of JOCAVI® products' range.
- Despite all the standard sizes of all products, this model can be customised upon previous consultation. Sizes may vary slightly due to their production method and some inherent raw-materials characteristics.



CAMOU[®]

ABSORBENT PANEL

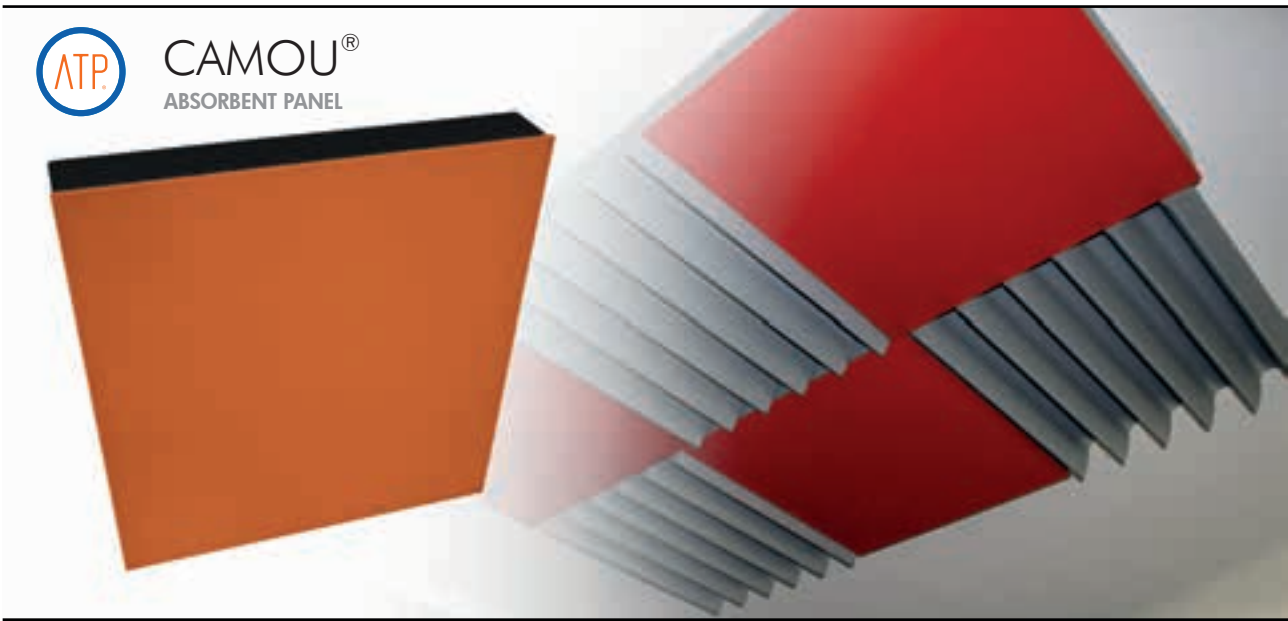

Image of 60x60cm model Ref.:CAM060 (on the left) and Ref.:CAM060 applied (ambient image).

DESCRIPTION

This panel is an updated version of the COSMOS[®] panel, but is distinct from it. It is an absorbent panel, in particular of the mid-range of the sound spectrum, and is meant to be mounted on walls and ceilings. This model has a fabric-coated front part and a support structure that gives it more mass and enables, therefore, quite different acoustic performances.

The CAMOU[®] may be used in any type of rooms to reduce airborne noise. It is particularly efficient in rooms where the aesthetic factor is more neutral. This panel can be glued directly on walls and ceilings. Mounting stripes are available for removable mounting. All installation accessories are sold separately. It can be installed by coupling several pieces that form a very absorbent surface with outstanding results. Its size makes it one of the best available options in the market. The back part is an EPS solid box which can be painted on request with our EPS available colours. The box interior's acoustic labyrinth is filled with recycled acoustic material.

FEATURES

- Fabric-coated acoustic regular foam on a rigid framework.
- NRC: **0.84/m²** [$>100\text{Hz}$; $<5\text{KHz}$].
- Fire-resistance: Fabric - Euroclass B (similar to old M1); EPS - Euroclass B-s3,d1 (similar to old M1).
- Several fabric colours available.
- Box available in raw white EPS or in raw black EPS.
- Box sides can optionally be painted to match the front colour.
- Very easy to install.

TECHNICAL DRAWINGS

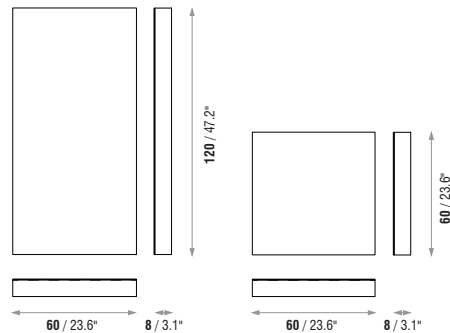

MODELS AND SIZES

MODELS	HEIGHT	WIDTH	DEPTH	WEIGHT
CAM120	120 cm (47.2 in)	60 cm (23.6 in)	8 cm (3.1 in)	3.4 Kg (7.50 lbs)
CAM060	60 cm (23.6 in)	60 cm (23.6 in)	8 cm (3.1 in)	1.7 Kg (3.75 lbs)

ABSORPTION COEFFICIENT

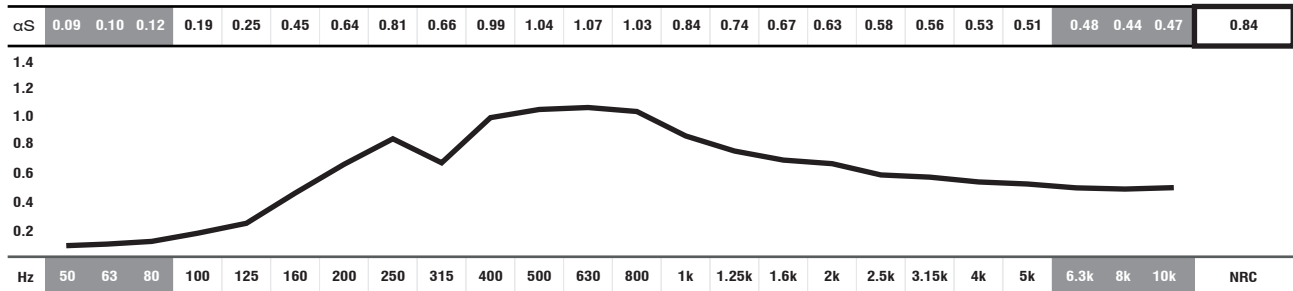

■ ABSORPTION COEFFICIENT: Values in accordance with the standards: EN 20654, ASTM C423 and EN 11654.

■ Values [$<100\text{Hz}$ and $>5\text{K}$] are Non Standard Values.

STANDARD FABRIC COLOURS - FRONT

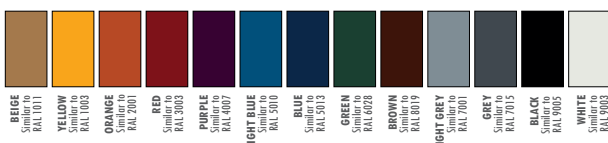

EPS BOX COLOURS

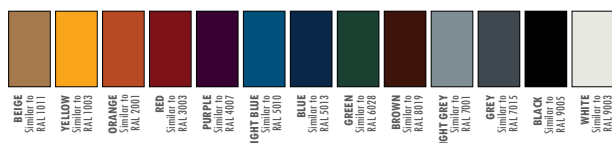

IMPORTANT NOTICES

- JOCAVI[®] accepts no responsibility for any printing errors. Specifications can be modified without prior notice, if technical or commercial reasons so require.
- RAL[®] is an international independent colour standard system partner for industry, trade, architecture and design. Should be consulted before placing any order.
- The colours shown on this catalogue are only a reference and an illustration of the products finishing. The colours shown are not binding because brightness, contrast and colour balance may vary due to the printing process.
- Colours may vary due to raw-material suppliers' changes and some differences may occur in tonal range.
- Typical Indoor Comfort Standards state a temperature range of 20°C - 27°C (68°F - 81°F), and a relative humidity of less than 60%. These would be considered as normal operational levels of JOCAVI[®] products' range.
- Sizes may vary slightly due to their production method and some inherent raw-materials characteristics.



BASMEL®

ABSORBENT PANEL

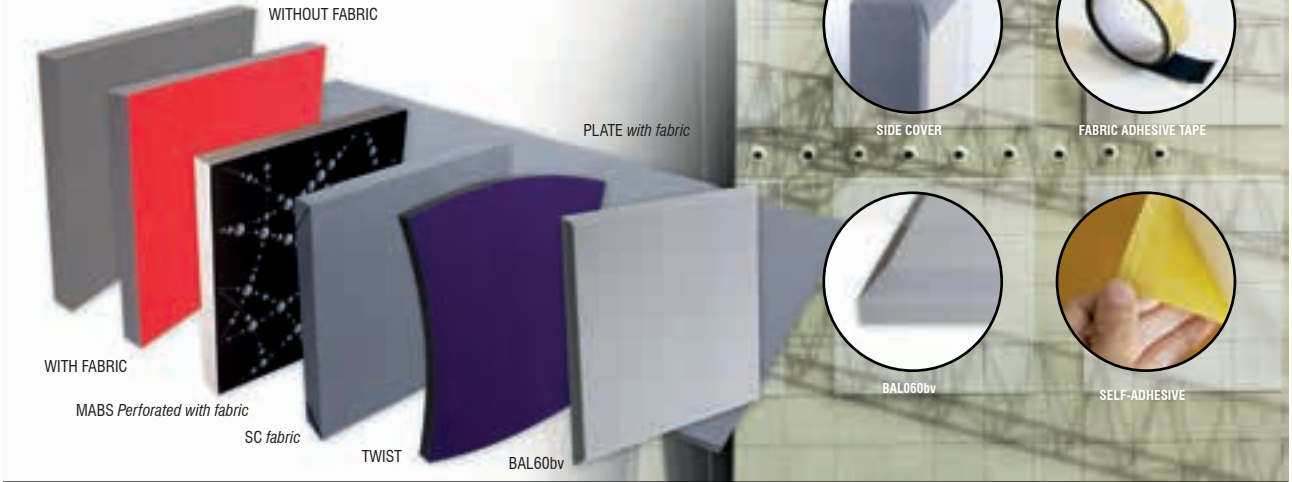

Image of 60x60cm models Ref.:BAL060 fabric (Red), Ref.:BAL060 and Ref.:BAM060 (perforated with black fabric), the BAL060sc, the BAL200.4 (plate with fabric), BAL060bv and Ref.:BAL200.4 custom made applied (ambient image).

DESCRIPTION

BASMEL® is a low-cost acoustic panel meant to be applied in large quantities on ceilings and walls. It is made of flexible open-cell melamine foam or of regular Acoustic Foam, a thermoset polymer and a fire-resistant fabric finished surface. Melamine foam gives this product an excellent sound absorption capacity; the sound waves penetrate the open-cell structure and dissipate, thus reducing the reflected energy.

BASMEL® is available in foam, fabric or velvet finishing. There are several available options and sizes including: flat sheets of foam, fabric-lined, chamfered edges, velvet finish and (MABS® 060) with hole punctures, mimicking the pattern of the COSMOS® model.

Is available with self-adhesive backs which allow for a very fast and easy installation. For more information on all the available options check the models and sizes table below.

To cover the union between the panels, we also have, as an option, a roll of self-adhesive fabric tape that can be applied. The BASMEL®'s acoustic and safety characteristics make this product ideal for use as a noise control and sound insulation device in buildings that have demanding fire protection requirements. It improves acoustics and soundproofing, thereby providing safety in accordance with environmental standards.

FEATURES

- Raw material: Melamine Foam or Regular Acoustic Foam.
- NRC: **0.80/m²** (40mm), **0.54/m²** (20mm) and **0.90/m²** (80mm - SIDE COVER Panels).
- **MELAMINE FOAM** - Flame resistance: Euroclass B-s1,d0 (similar to old M1 France, Germany B1,GB class1, USA V0/HF1).
- **ACOUSTIC FOAM** - Flame resistance: Euroclass B-s3,d1 (similar to old M1).
- Mounting glue and **FABRIC ADHESIVE FINISHING TAPE** sold separately.
- **SELF-ADHESIVE** option available on request.

TECHNICAL DRAWINGS

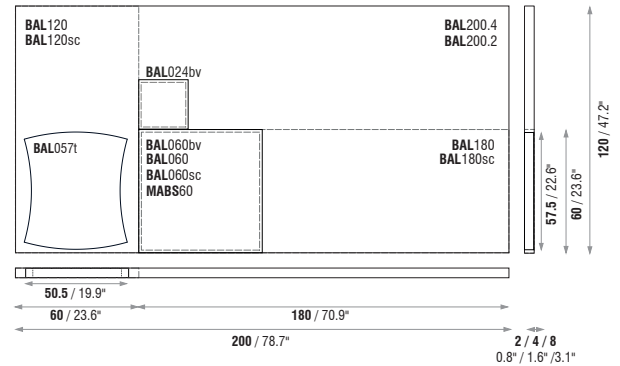

MODELS AND SIZES

MODELS	HEIGHT	WIDTH	DEPTH	WEIGHT
TWT057	57,5 cm (22.6 in)	50,5 cm (19.9 in)	4 cm (1.6 in)	0.3 Kg (0.66 lbs)
BAL180	180 cm (70.9 in)	60 cm (23.6 in)	4 cm (1.6 in)	0.9 Kg (1.98 lbs)
BAL120	120 cm (47.2 in)	60 cm (23.6 in)	4 cm (1.6 in)	0.6 Kg (1.32 lbs)
BAL060	60 cm (23.6 in)	60 cm (23.6 in)	4 cm (1.6 in)	0.3 Kg (0.66 lbs)
BAL200.4/2	200 cm (78.7 in)	120 cm (47.2 in)	4/2 cm (1.6/0.8 in)	2.24 Kg (4.94 lbs)
BAL060bv	60 cm (23.6 in)	60 cm (23.6 in)	4 cm (1.6 in)	0.3 Kg (0.66 lbs)
BAL180sc	180 cm (70.9 in)	60 cm (23.6 in)	8 cm (3.1 in)	1.2 Kg (2.65 lbs)
BAL120sc	120 cm (47.2 in)	60 cm (23.6 in)	8 cm (3.1 in)	0.9 Kg (1.98 lbs)
BAL060sc	60 cm (23.6 in)	60 cm (23.6 in)	8 cm (3.1 in)	0.6 Kg (1.37 lbs)
MABS060	60 cm (23.6 in)	60 cm (23.6 in)	4 cm (1.6 in)	0.21 Kg (0.46 lbs)
BAL024bv	24 cm (9.44 in)	24 cm (9.44 in)	4 cm (1.6 in)	0.05 Kg (0.11 lbs)

ABSORPTION COEFFICIENT

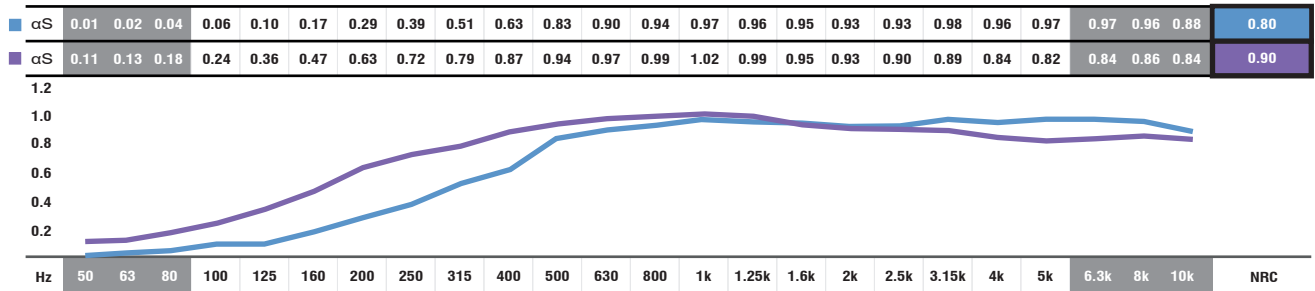

■ ■ ABSORPTION COEFFICIENT: Values in accordance with the standards: EN 20654, ASTM C423 and EN 11654.

■ Values [<100Hz and > 5K] are Non Standard Values.

STANDARD FABRIC COLOURS



REGULAR & MELAMINE FOAM COLOURS & VELVETY FINISHINGS



IMPORTANT NOTICES

- JOCAVI® accepts no responsibility for any printing errors. Specifications can be modified without prior notice, if technical or commercial reasons so require.
- RAL® is an international independent colour standard system partner for industry, trade, architecture and design. Should be consulted before placing any order.
- The colours shown on this catalogue are only a reference and an illustration of the products finishing. The colours shown are not binding because brightness, contrast and colour balance may vary due to the printing process.
- Colours may vary due to raw-material suppliers' changes and some differences may occur in tonal range.
- Typical Indoor Comfort Standards state a temperature range of 20°C - 27°C (68°F - 81°F), and a relative humidity of less than 60%. These would be considered as normal operational levels of JOCAVI® products' range.
- Despite all the standard sizes of all products, this model can be customised upon previous consultation. Sizes may vary slightly due to their production method and some inherent raw-materials characteristics.



BASMEL® / CLOUD

ABSORBENT PANEL

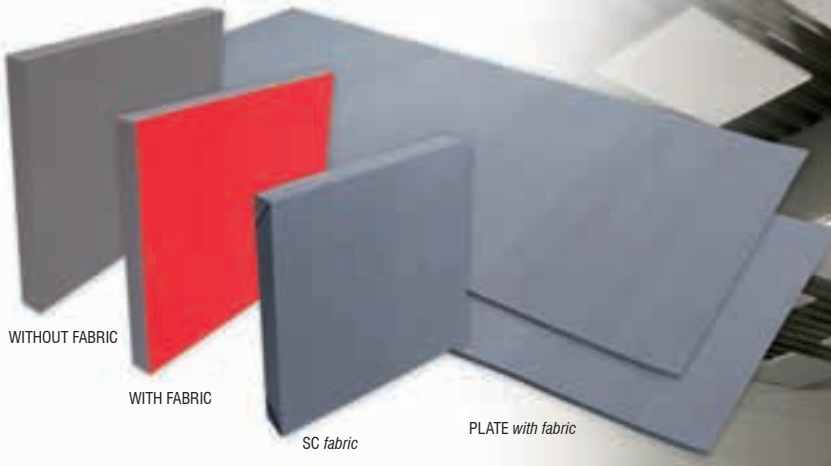

Image of 60x60cm models Ref.:BAL060 fabric (Red),Ref.:BAL060, the BAL060sc, the BAL200.4 (plate with fabric) and Ref.:BAL200.4 custom made applied (ambient image).

DESCRIPTION

BASMEL CLOUD® is a low-cost acoustic panel to be suspended as clouds on ceilings. Depending on the distance to the ceiling the suspension wires and accessories are sold separately.

This model is made of flexible open-cell melamine foam or of regular Acoustic Foam, a thermoset polymer and a fire-resistant fabric finished surface, which has on the back a flat plate with the required attachment points for its suspension.

Melamine foam gives this product an excellent sound absorption capacity; the sound waves penetrate the open-cell structure and dissipate, thus reducing the reflected energy.

BASMEL CLOUD® is available in foam, fabric or velvet finishing. There are several available different options and sizes including: flat sheets of foam, fabric-lined, chamfered edge and velvet finish. For more information on all the available options check the models and sizes table below.

The BASMEL CLOUD® acoustic and safety characteristics make this product ideal for use as a noise control and sound insulation device in buildings that have demanding fire protection requirements. It improves acoustics and soundproofing, thereby providing safety in accordance with environmental standards.

FEATURES

- Raw material: Melamine Foam or Regular Acoustic Foam.
- NRC: **0.80/m²** (40mm), **0.54/m²** (20mm) and **0.90/m²** (80mm - SIDE COVER Panels).
- **MELAMINE FOAM** - Flame resistance: Euroclass B-s1,d0 (similar to old M1 France, Germany B1,GB class1, USA V0/HF1).
- **ACOUSTIC FOAM** - Flame resistance: Euroclass B-s3,d1 (similar to old M1).
- Mounting glue and **FABRIC ADHESIVE FINISHING TAPE** sold separately.
- **SELF-ADHESIVE** option available on request.

TECHNICAL DRAWINGS

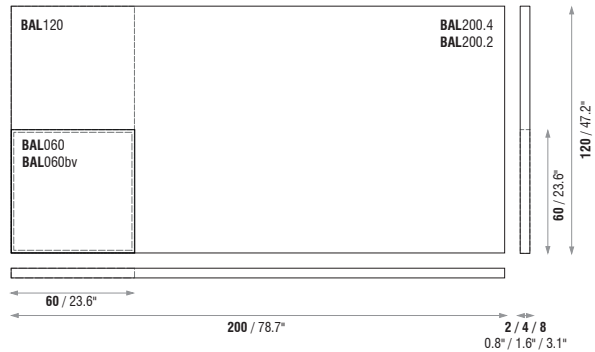

MODELS AND SIZES

MODELS	HEIGHT	WIDTH	DEPTH	WEIGHT
BAL120CL	120 cm (47.2 in)	60 cm (23.6 in)	4 cm (1.6 in)	0.6 Kg (1.32 lbs)
BAL060CL	60 cm (23.6 in)	60 cm (23.6 in)	4 cm (1.6 in)	0.3 Kg (0.66 lbs)
BAL200.4/2CL	200 cm (78.7 in)	120 cm (47.2 in)	4/2 cm (1.6/0.8 in)	2.24 Kg (4.94 lbs)
BAL120scCL	120 cm (47.2 in)	60 cm (23.6 in)	8 cm (3.1 in)	0.6 Kg (1.37 lbs)
BAL060scCL	60 cm (23.6 in)	60 cm (23.6 in)	8 cm (3.1 in)	0.31 Kg (0.68 lbs)
BAL060bvCL	60 cm (23.6 in)	60 cm (23.6 in)	4 cm (1.6 in)	0.3 Kg (0.66 lbs)

ABSORPTION COEFFICIENT

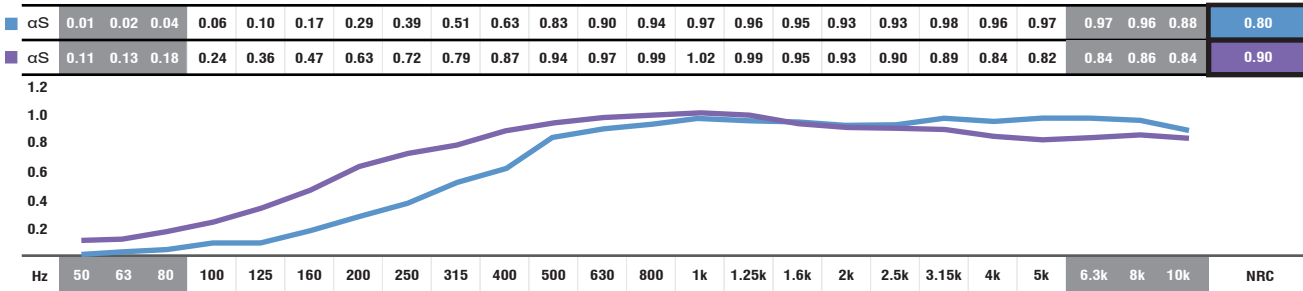

■ ■ ABSORPTION COEFFICIENT: Values in accordance with the standards: EN 20654, ASTM C423 and EN 11654. ■ Values [$< 100\text{Hz}$ and $> 5\text{K}$] are Non Standard Values.

STANDARD FABRIC COLOURS

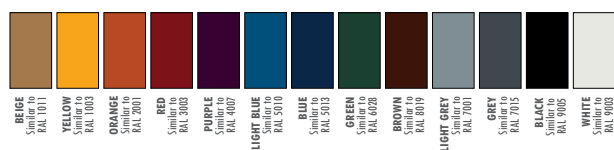

REGULAR & MELAMINE FOAM COLOURS & VELVETY FINISHINGS

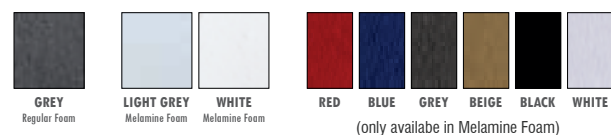

IMPORTANT NOTICES

- JOCAVI® accepts no responsibility for any printing errors. Specifications can be modified without prior notice, if technical or commercial reasons so require.
- RAL® is an international independent colour standard system partner for industry, trade, architecture and design. Should be consulted before placing any order.
- The colours shown on this catalogue are only a reference and an illustration of the products finishing. The colours shown are not binding because brightness, contrast and colour balance may vary due to the printing process.
- Colours may vary due to raw-material suppliers' changes and some differences may occur in tonal range.
- Typical Indoor Comfort Standards state a temperature range of 20°C - 27°C (68°F - 81°F), and a relative humidity of less than 60%. These would be considered as normal operational levels of JOCAVI® products' range.
- Despite all the standard sizes of all products, this model can be customised upon previous consultation. Sizes may vary slightly due to their production method and some inherent raw-materials characteristics.



COSMOS®
ABSORBENT PANEL

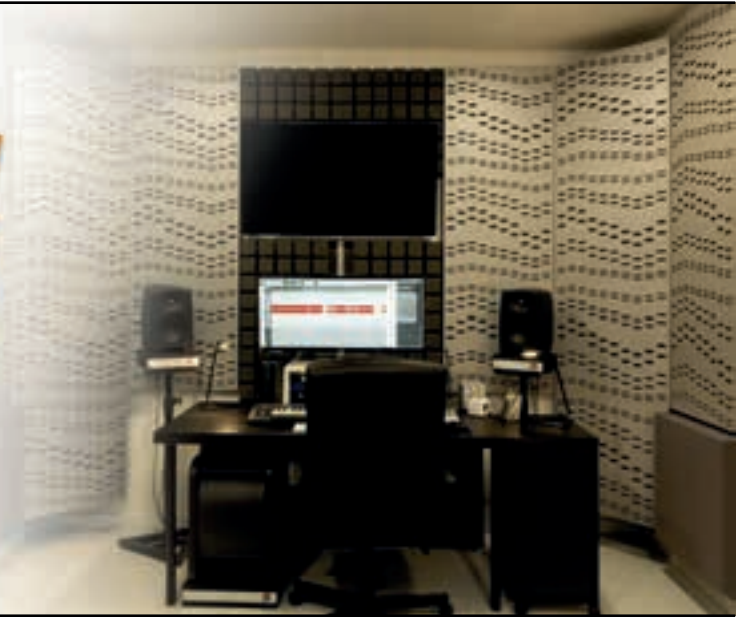

Image of 60x60cm model Ref.:COS060 (on the left) and Ref.:COS060 applied (ambient image).

DESCRIPTION

The COSMOS® is an acoustic panel with a set of four different aesthetics that meet all kinds of requirements. It is an acoustic solution for commercial areas, offices, public spaces, as well as audio and video studios.

Acoustic designers usually favour this type of covering because it is efficient and has a refined finishing as well. These are inexpensive and very attractive proposals.

The 8cm thickness and the inside labyrinth provide COSMOS® with a high absorption coefficient.

This absorbent panel comprises the full spectrum of the human voice and is used to absorb slap and flutter echoes in the room, thus allowing a more pleasant and accurate listening environment.

This model proposes four different perforations and five synthetic-wood finishes, as well as a flexible design with coupling options for the several pieces, therefore enabling different and varied aesthetic combinations.

TECHNICAL DRAWINGS

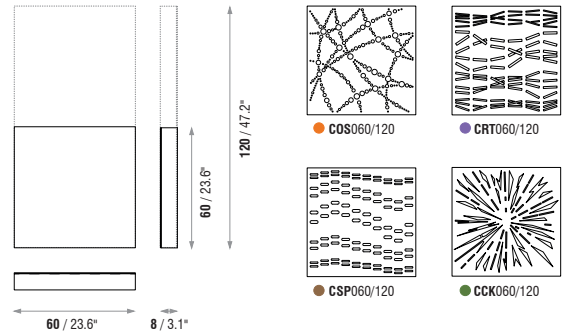

FEATURES

- Rigid melamine faced board framework on a HD EPS box.
- NRC: **0.79/m²**(COSMOS), **0.88/m²**(SP), **0.89/m²**(RT), **0.80/m²**(CK)[>250Hz; <1KHz].
- Fire-resistance: Melamine Faced Board - Euroclass B-s2,d0 (similar to old M1); EPS - Euroclass B-s3,d1 (similar to old M1).
- Several fabric colours available.
- Box available in raw white EPS or in raw black EPS.
- Box sides can optionally be painted to match the front colour.
- Very easy to install.

MODELS AND SIZES

MODELS	HEIGHT	WIDTH	DEPTH	WEIGHT
COS120	120 cm (47.2 in)	60 cm (23.6 in)	8 cm (3.1 in)	3.4 Kg (7.50 lbs)
COS060	60 cm (23.6 in)	60 cm (23.6 in)	8 cm (3.1 in)	1.7 Kg (3.75 lbs)

ABSORPTION COEFFICIENT

αS	010	011	014	016	028	043	058	077	092	1.06	1.10	1.05	0.95	0.74	0.66	0.59	0.55	0.51	0.46	0.42	0.39	0.39	0.37	0.36	0.79
αS	0.09	0.10	0.12	0.19	0.31	0.44	0.57	0.76	0.93	0.98	1.04	1.09	1.12	1.08	0.92	0.77	0.63	0.48	0.47	0.45	0.44	0.43	0.42	0.42	0.88
αS	0.11	0.12	0.16	0.18	0.29	0.41	0.54	0.74	0.90	1.02	1.04	1.06	1.10	1.11	1.08	0.84	0.62	0.52	0.47	0.42	0.38	0.36	0.36	0.35	0.89
αS	0.10	0.11	0.15	0.16	0.26	0.40	0.54	0.73	0.87	0.93	0.97	1.00	1.01	0.98	0.73	0.61	0.52	0.47	0.43	0.41	0.34	0.33	0.33	0.32	0.80

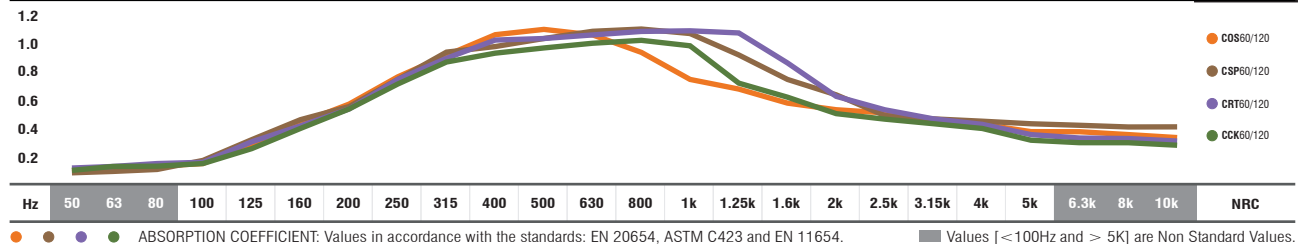

WOOD FACED BOARD FINISHINGS

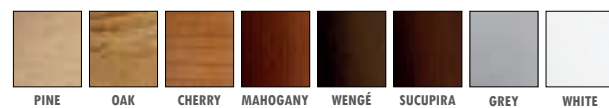

EPS BOX COLOURS



IMPORTANT NOTICES

- JOCAVI® accepts no responsibility for any printing errors. Specifications can be modified without prior notice, if technical or commercial reasons so require.
- The colours shown on this catalogue are only a reference and an illustration of the products finishing. The colours shown are not binding because brightness, contrast and colour balance may vary due to the printing process.
- Colours may vary due to raw-material suppliers' changes and some differences may occur in tonal range.
- Due to its natural origin, wood-based products will always present natural imperfections inherent to the organic nature. And for similar reasons, they will also present traces of old-age in the course of time.
- Wood and Fabric products are highly susceptible to change its appearance with humidity and temperature. Close attention must be paid to the storage conditions and the acclimatization before, during and after the installation.
- Typical Indoor Comfort Standards state a temperature range of 20°C - 27°C (68°F - 81°F), and a relative humidity of less than 60%. These would be considered as normal operational levels of JOCAVI® products' range.
- Despite all the standard sizes of all products, this model can be customised upon previous consultation. Sizes may vary slightly due to their production method and some inherent raw-materials characteristics.



COOKIE® / CLOUD

ABSORBENT PANEL



Image of 60x60cm pair models Ref.:COK060 (on the left) and the same applied (ambient image).

DESCRIPTION

COOKIE® is made of a melamine foam or flexible open-cell self-extinguishable acoustic foam. Its appearance describes a circular shape and it is supplied in two different diameters. The optional velvet finishing gives this product an attractive luxury look.

COOKIE®'s acoustic characteristics make this product ideal for use as a noise control device in interior environments. It improves airborne noise reduction while also providing fire safety requirements.

Due to its low weight, COOKIE® allows the creation of large-surface areas that can be glued directly on to the surface or hung on ceilings with metal wire as an option, giving rooms an attractive appearance.

Meeting rooms, offices and hotel foyers can be acoustically upgraded just as effective and attractive by using this product. The installation method is very simple using mounting glue. The melamine foam raw material of this product meets the most important international fire safety regulations. It is produced without using halogenated hydrocarbons, flame-retardants and/or toxic heavy metals.

FEATURES

- NRC: **0.90/m²** [$>250\text{Hz}$; $<10\text{kHz}$].
- **MELAMINE FOAM** - Flame resistance: Euroclass B-s1,d0 (similar to old M1 France, Germany B1,GB class1, USA V0/HF1).
- **ACOUSTIC FOAM** - Flame resistance: Euroclass B-s3,d1 (similar to old M1).
- Good thermal insulation properties and constant physical properties over a wide temperature range.
- Resistance to all organic solvents.
- Sold in pairs.
- Mounting: glued or suspended.

ABSORPTION COEFFICIENT*

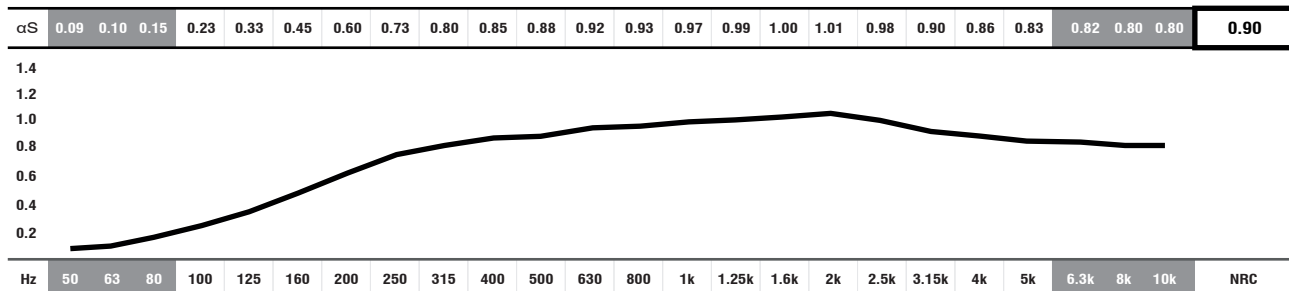

■ ABSORPTION COEFFICIENT: Values in accordance with the standards: EN 20654, ASTM C423 and EN 11654.

■ Values [$<100\text{Hz}$ and $>5\text{K}$] are Non Standard Values.

*PANEL DATA ONLY OF REF.: COK060.6 VELVETY FINISHING.

TECHNICAL DRAWINGS

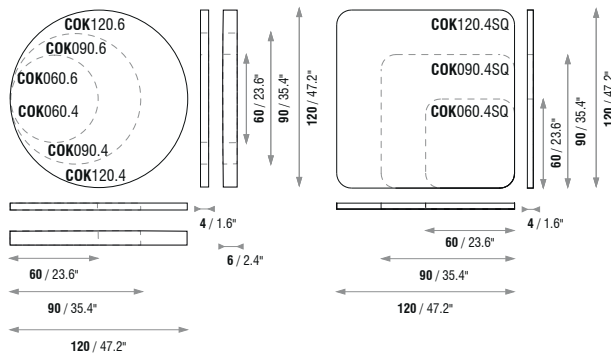

MODELS AND SIZES

MODELS	HEIGHT	DIAMETER	WEIGHT
COK120.6	6 cm (2.4 in)	∅120 cm (47.2 in)	1.1 Kg (2.43 lbs)
COK/SQ/120.4	4 cm (1.6 in)	∅120 cm (47.2 in)	0.7 Kg (1.54 lbs)
COK090.6	6 cm (2.4 in)	∅90 cm (35.4 in)	0.6 Kg (1.32 lbs)
COK/SQ/090.4	4 cm (1.6 in)	∅90 cm (35.4 in)	0.4 Kg (0.88 lbs)
COK060.6	6 cm (2.4 in)	∅60 cm (23.6 in)	0.45 Kg (0.99 lbs)
COK/SQ/060.4	4 cm (1.6 in)	∅60 cm (23.6 in)	0.3 Kg (0.66 lbs)

SOLD IN PAIRS

REGULAR AND MELAMINE FOAM COLOURS



VELVETY FINISHINGS (only available in Melamine Foam)



IMPORTANT NOTICES

- JOCAVI® accepts no responsibility for any printing errors. Specifications can be modified without prior notice, if technical or commercial reasons so require.
- RAL® is an international independent colour standard system partner for industry, trade, architecture and design. Should be consulted before placing any order.
- The colours shown on this catalogue are only a reference and an illustration of the products finishing. The colours shown are not binding because brightness, contrast and colour balance may vary due to the printing process.
- Colours may vary due to raw-material suppliers' changes and some differences may occur in tonal range.
- Typical Indoor Comfort Standards state a temperature range of 20°C - 27°C (68°F - 81°F), and a relative humidity of less than 60%. These would be considered as normal operational levels of JOCAVI® products' range.
- Despite all the standard sizes of all products, this model can be customised upon previous consultation. Sizes may vary slightly due to their production method and some inherent raw-materials characteristics.



Image of a pair of the 96x30cm model Ref.:DAT096 (on the left) and Ref.:DAT096 applied (ambient image).

DESCRIPTION

The DECOART® is an acoustic treatment absorber made of self-extinguishing acoustic foam. It has an angular arc-shaped geometry describing two elevations "up and down" that make it very attractive when combined with numerous modules.

When observed from a perpendicular perspective, it has a beautiful and harmonised appearance, which is particularly attractive for common areas in public spaces.

The creation of surfaces that are efficient at absorbing sound waves becomes imperative, and that is the main feature that makes this product so relevant.

The DECOART® is perfect to cover continuous areas of walls or ceilings as a coating material and can be used as a soundproofing reinforcement as well.

It is ideal for commercial areas, television studios, pavilions, auditoriums, meeting rooms, public spaces, etc., that need specific care regarding airborne noise control. It can be easily cut with a knife to be adjusted to the dimensions of walls and ceilings.

FEATURES

- Raw material: Melamine Foam or Regular Acoustic Foam.
- NRC: **0.84/m²** [$>250\text{Hz}$; $<10\text{kHz}$].
- **MELAMINE FOAM** - Flame resistance: Euroclass B-s1,d0 (similar to old M1 France, Germany B1,GB class1, USA V0/HF1).
- **ACOUSTIC FOAM** - Flame resistance: Euroclass B-s3,d1 (similar to old M1).
- Velvety Finishing available.
- Shape and design recommended for continuous surface treatment.
- 100% recyclable.
- Sold in pairs

ABSORPTION COEFFICIENT

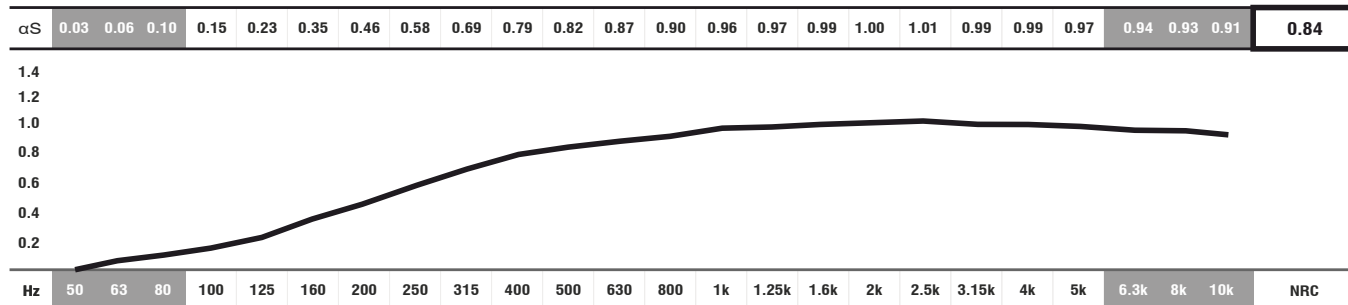

■ ABSORPTION COEFFICIENT: Values in accordance with the standards: EN 20654, ASTM C423 and EN 11654.

■ Values [$<100\text{Hz}$ and $>5\text{K}$] are Non Standard Values.

*PANEL DATA ONLY OF REF.: DAT096 REGULAR FOAM.

TECHNICAL DRAWINGS

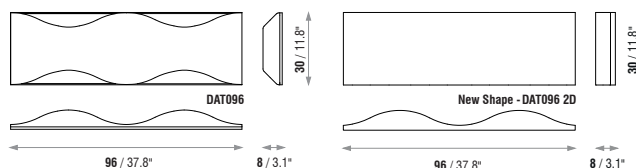

UPDATED SHAPE

MODELS AND SIZES

MODELS	HEIGHT	WIDTH	DEPTH	WEIGHT
*DAT096	96 cm (37.8 in)	30 cm (11.8 in)	8 cm (3.1 in)	*0.9 Kg (1.98 lbs)
*DAT0962D	96 cm (37.8 in)	30 cm (11.8 in)	8 cm (3.1 in)	*0.9 Kg (1.98 lbs)

*SOLD IN PAIRS - (weight of pair)

REGULAR AND MELAMINE FOAM COLOURS



VELVETY COLOURS (only available in Melamine Foam)



IMPORTANT NOTICES

- JOCAVI® accepts no responsibility for any printing errors. Specifications can be modified without prior notice, if technical or commercial reasons so require.
- The colours shown on this catalogue are only a reference and an illustration of the products finishing. The colours shown are not binding because brightness, contrast and colour balance may vary due to the printing process.
- Colours may vary due to raw-material suppliers' changes and some differences may occur in tonal range.
- Typical Indoor Comfort Standards state a temperature range of 20°C - 27°C (68°F - 81°F), and a relative humidity of less than 60%. These would be considered as normal operational levels of JOCAVI® products' range.
- Despite all the standard sizes of all products, this model can be customised upon previous consultation. Sizes may vary slightly (+/-3mm) due to their production method and some inherent raw-materials characteristics.



FOAMSORB® /INVERTED

ABSORBENT PANEL



Image of 60x60cm models Ref.:FSO060 and Ref.:FSI060 (on the left) and Ref.:FSO060 and Ref.:FSI060 applied (ambient image).

DESCRIPTION

The FOAMSORB INV® absorption panels are ATP® registered products and the real mid-range absorbers from our collection. They can be made of high-quality controlled-cell, acoustic foam or melamine foam.

The FOAMSORB INV® panels present a unique and elegant design; the male and female pieces help solve many of the rooms' acoustic anomalies.

These panels have a high absorption coefficient in the broad range of the sound spectrum, and are significantly efficient at absorbing medium-low frequencies.

In general terms, they work well on flat walls and ceilings. They can be combined with the WAVYFUSER INV® diffusion panels, which have the same shape, thus giving music rooms a truly balanced continuous acoustic treatment surface and a fine-looking design.

FEATURES

- Raw material: Melamine Foam or Regular Acoustic Foam.
- NRC: **0.95/m²** [$>250\text{Hz}; <10\text{KHz}$].
- **MELAMINE FOAM** - Flame resistance: Euroclass B-s1,d0 (similar to old M1 France, Germany B1,GB class1, USA V0/HF1).
- **ACOUSTIC FOAM** - Flame resistance: Euroclass B-s3,d1 (similar to old M1).
- Great decorative alternatives.
- Sold in pairs.

TECHNICAL DRAWINGS

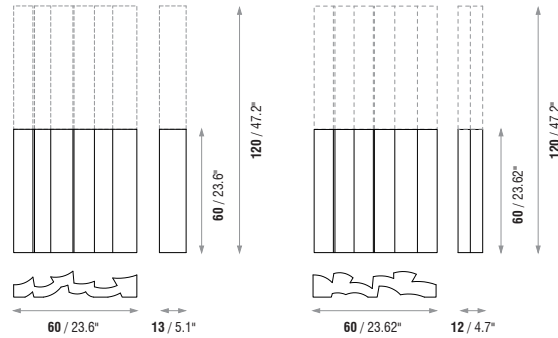

MODELS AND SIZES

MODELS	HEIGHT	WIDTH	DEPTH	WEIGHT
FSO120	120 cm (47.2 in)	60 cm (23.6 in)	13 cm (5.1 in)	1.2 Kg (2.65 lbs)
FSI120	120 cm (47.2 in)	60 cm (23.6 in)	12 cm (4.7 in)	1.2 Kg (2.65 lbs)
FSO060	60 cm (23.6 in)	60 cm (23.6 in)	13 cm (5.1 in)	0.6 Kg (1.32 lbs)
FSI060	60 cm (23.6 in)	60 cm (23.6 in)	12 cm (4.7 in)	0.6 Kg (1.32 lbs)

SOLD IN PAIRS

ABSORPTION COEFFICIENT

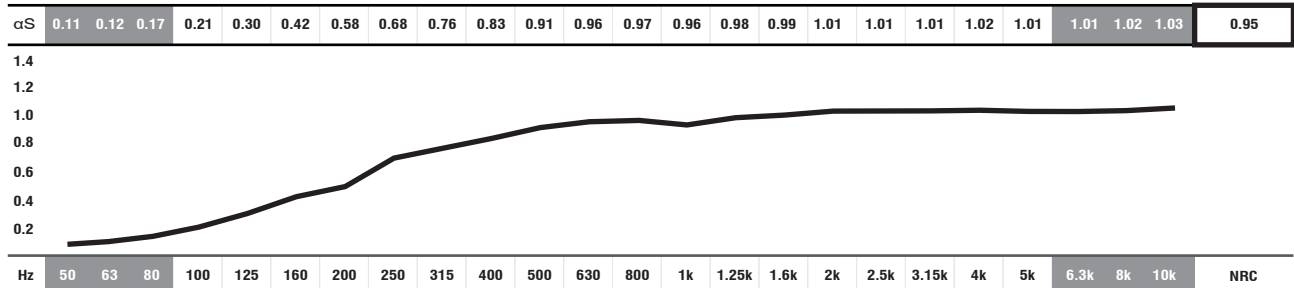

■ ABSORPTION COEFFICIENT: Values in accordance with the standards: EN 20654, ASTM C423 and EN 11654.

■ Values [$<100\text{Hz}$ and $>5\text{K}$] are Non Standard Values.

REGULAR AND MELAMINE FOAM COLOURS



VELVETY FINISHINGS (only available in Melamine Foam)



IMPORTANT NOTICES

- JOCAVI® accepts no responsibility for any printing errors. Specifications can be modified without prior notice, if technical or commercial reasons so require.
- The colours shown on this catalogue are only a reference and an illustration of the products finishing. The colours shown are not binding because brightness, contrast and colour balance may vary due to the printing process.
- Colours may vary due to raw-material suppliers' changes and some differences may occur in tonal range. Close attention must be paid to the storage conditions and the acclimatization before, during and after the installation.
- Typical Indoor Comfort Standards state a temperature range of 20°C - 27°C (68°F - 81°F), and a relative humidity of less than 60%. These would be considered as normal operational levels of JOCAVI® products' range.
- Despite all the standard sizes of all products, this model can be customised upon previous consultation. Sizes may vary slightly due to their production method and some inherent raw-materials characteristics.



NOVEN[®]
ABSORBENT PANEL

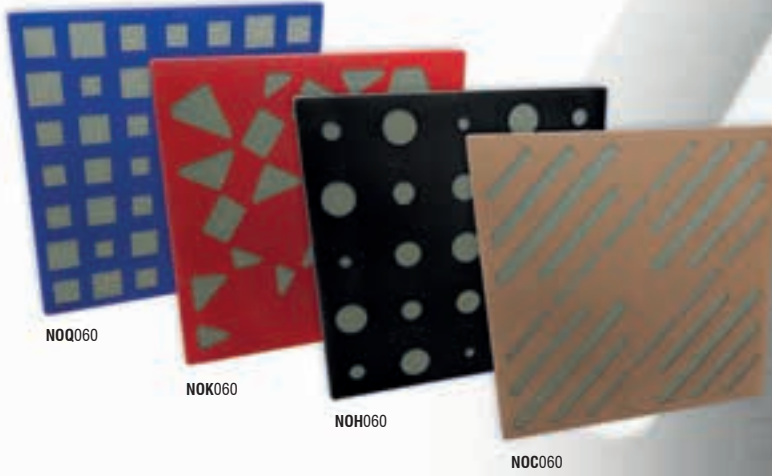

Image of 60x60cm models Ref.:NOK060, NOQ060, NOH060 and NOC060.

DESCRIPTION

NOVEN[®] is a perforated flat shape acoustic panel. It is made of a flexible open-cell acoustic foam with a rigid housing of perforated HIPS, with coloured velvety finishing. This attractive product allows the combination of two colours; the colour of the housing and color of the acoustic foam or its fabric color, giving its appearance a several appealing colour combinations. The inner absorbing core is made of open-cell acoustic foam composing the inner absorption core with fire-resistant fabric finishing.

A great approach to controlling noise, excess reverberation and sound reflections is to use acoustic absorption modules for decorative reasons.

Commercial areas, public spaces, airports, offices and hotel foyers can be easily acoustically treated with this effective and attractive solution, giving rooms an attractive appearance. NOVEN[®] can be applied in large quantities on ceilings and walls. It can be applied with the provided glue, or, optionally with self-adhesive on the back, allowing a very fast and easy installation. The installation method was optimized to have a great effect in: restaurants, bars and pubs, meeting rooms, mid and large rooms such as pavilions, auditoriums, etc.

FEATURES

- Perforated HIPS with velvety finishing and acoustic foam with fabric.
- NRC: **0.77/m²**(KLMT), **0.83/m²**(QRD), **0.79/m²**(HOL), **0.79/m²**(CTR) [$>250\text{Hz}; <1\text{KHz}$].
- Available in four different aesthetic decorative options and perforations.
- HIPS front - Flame resistance - VO - UL94 Standards (similar to old M2);
- **ACOUSTIC FOAM** - Flame resistance: Euroclass B-s3,d1 (similar to old M1).
- Very easy to install.

TECHNICAL DRAWINGS

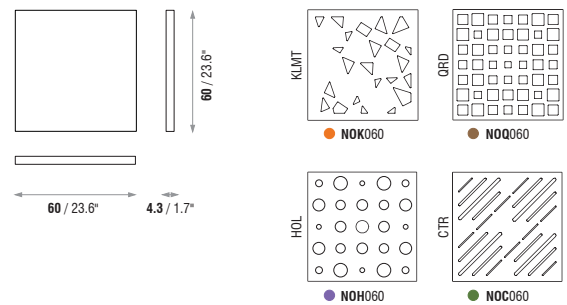

MODELS AND SIZES

MODELS	HEIGHT	WIDTH	DEPTH	WEIGHT
● NOK060	60 cm (23.6 in)	60 cm (23.6 in)	4.3 cm (1.7 in)	1.1 Kg (2.43 lbs)
● NOQ060	60 cm (23.6 in)	60 cm (23.6 in)	4.3 cm (1.7 in)	1.1 Kg (2.43 lbs)
● NOH060	60 cm (23.6 in)	60 cm (23.6 in)	4.3 cm (1.7 in)	1.1 Kg (2.43 lbs)
● NOC060	60 cm (23.6 in)	60 cm (23.6 in)	4.3 cm (1.7 in)	1.1 Kg (2.43 lbs)

ABSORPTION COEFFICIENT

● αS	0.08	0.09	0.12	0.13	0.20	0.35	0.42	0.60	0.70	0.82	0.89	0.92	0.95	0.91	0.85	0.78	0.68	0.59	0.44	0.41	0.37	0.31	0.29	0.28	0.77
● αS	0.07	0.08	0.10	0.15	0.25	0.36	0.48	0.65	0.75	0.88	0.97	0.98	1.02	0.96	0.88	0.81	0.75	0.68	0.55	0.46	0.43	0.39	0.39	0.33	0.83
● αS	0.09	0.10	0.13	0.14	0.21	0.33	0.45	0.61	0.72	0.83	0.91	0.92	0.96	0.93	0.86	0.77	0.69	0.62	0.48	0.42	0.37	0.34	0.32	0.29	0.79
● αS	0.08	0.09	0.11	0.14	0.22	0.34	0.45	0.62	0.73	0.84	0.92	0.93	0.97	0.92	0.87	0.77	0.68	0.60	0.45	0.40	0.39	0.33	0.30	0.28	0.79

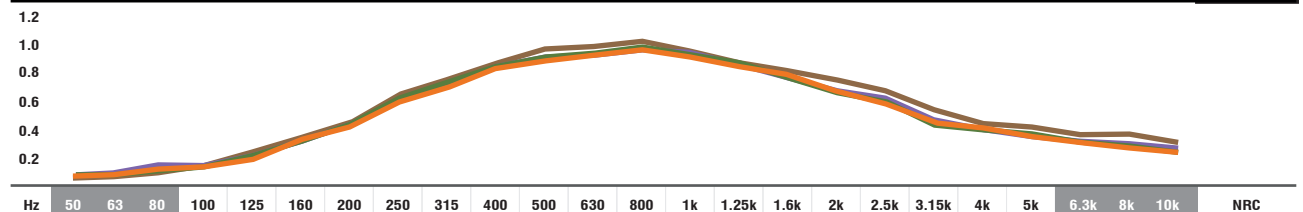

● ● ● ● ABSORPTION COEFFICIENT: Values in accordance with the standards: EN 20654, ASTM C423 and EN 11654. ■ Values [$<100\text{Hz}$ and $>5\text{K}$] are Non Standard Values.

VELVETY FINISHINGS (FRONT)

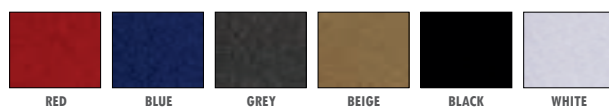

STANDARD FABRIC COLOURS (INTERIOR)

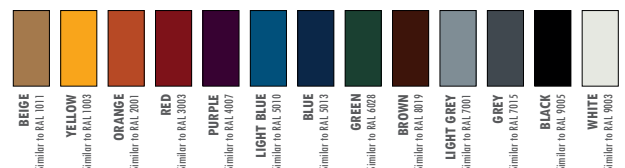

IMPORTANT NOTICES

- JOCAVI[®] accepts no responsibility for any printing errors. Specifications can be modified without prior notice, if technical or commercial reasons so require.
- The colours shown on this catalogue are only a reference and an illustration of the products finishing. The colours shown are not binding because brightness, contrast and colour balance may vary due to the printing process.
- Colours may vary due to raw-material suppliers' changes and some differences may occur in tonal range.
- Typical Indoor Comfort Standards state a temperature range of 20°C - 27°C (68°F - 81°F), and a relative humidity of less than 60%. These would be considered as normal operational levels of JOCAVI[®] products' range.
- Despite all the standard sizes of all products, this model can be customised upon previous consultation. Sizes may vary slightly due to their production method and some inherent raw-materials characteristics.



PET/ABS[®]
ABSORBENT PANEL

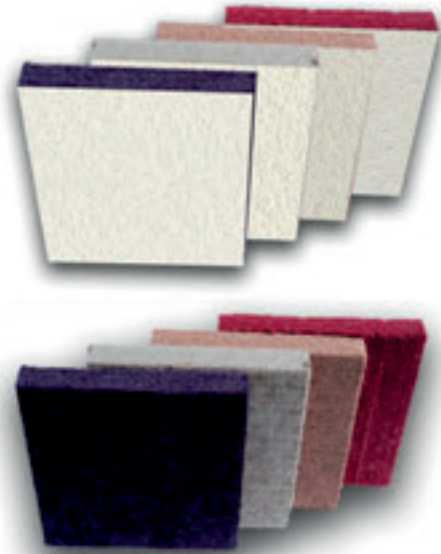

Image of a 60x60x1,2cm PETABS060 model (on the left) on the top right small samples.

DESCRIPTION

This very attractive and decorative acoustic treatment panel for everyday usage was specially developed to be applied as part of the interior design, adequate for the most comfortable workplaces and in public spaces. With PETABS[®] sound-absorbing materials, the airborne noise can be reduced within working spaces and living environment in the greatest extent, especially dealing with the acoustic environment and improving sound intelligibility within the room. PETABS[®] natural fibers are manufactured using high performance recycled polyester fibers by wasting hot pressing process to agglomerate the thickness, shape and density. This line of acoustic panels offer exceptional sound absorption, are thermally bonded for durability, contributing to healthy indoor air quality. Treated with a non-toxic solution that acts as an excellent fire retardant. Actively inhibits, as well, the growth of mildew, mold and bacteria. For walls and ceilings in public spaces and in various types of environments; workspaces, hotels, multi-function halls, conference rooms, gyms, where acoustic and aesthetics performance appeal are important, within a controlled budget. They are available in a several colors. PETABS[®] panels offer high-performance solutions and sustainability to give your project the charming superiority.

FEATURES

- Raw materials: IN® Groutpaint® finished face + natural recycled polyester fibre.
- NRC: **0.80/m²** - 12 mm thickness.
- **POLYESTER FIBER** / PET - Class B, EN13501-1:2007 + A1:2009. Fire classification of construction products & building elements. Thermal conductivity [W/(m.K)] 0.039.
- Thermal resistance: [(m2.K)/W] 0.254 - EN 12667:2001.
- Very easy to install, mounting glue sold separately.
- 100% recyclable.

TECHNICAL DRAWINGS

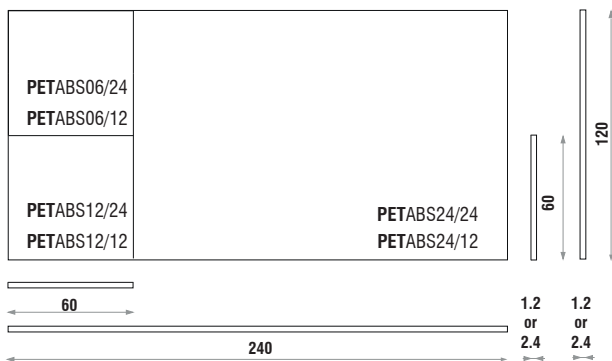

MODELS AND SIZES

MODELS	HEIGHT	WIDTH	DEPTH	WEIGHT
PETABS24/24	240 cm (94.49 in)	120 cm (47.24 in)	2.4 cm (0.94 in)	6.4 Kg (14.11 lbs)
PETABS24/12	240 cm (94.49 in)	120 cm (47.24 in)	1.2 cm (0.47 in)	3.2 Kg (7.05 lbs)
PETABS12/24	120 cm (47.24 in)	60 cm (23.62 in)	2.4 cm (0.94 in)	1.6 Kg (3.52 lbs)
PETABS12/12	120 cm (47.24 in)	60 cm (23.62 in)	1.2 cm (0.47 in)	0.8 Kg (1.76 lbs)
PETABS06/24	60 cm (23.62 in)	60 cm (23.62 in)	2.4 cm (0.94 in)	0.8 Kg (1.76 lbs)
PETABS06/12	60 cm (23.62 in)	60 cm (23.62 in)	1.2 cm (0.47 in)	0.4Kg (0.88 lbs)

ABSORPTION COEFFICIENT

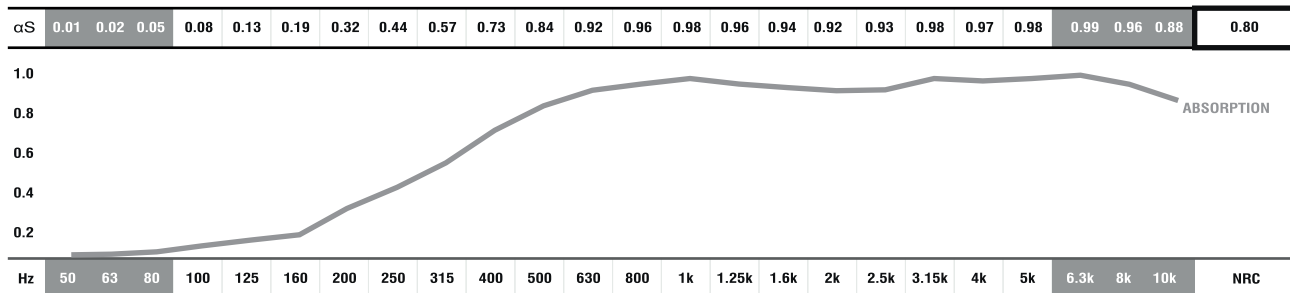

■ ABSORPTION COEFFICIENT: Values in accordance with the standards: EN 20654, ASTM C423 and EN 11654.

■ Values [$<100\text{Hz}$ and $>5\text{K}$] are Non Standard Values.

GROUTPAINT FINISHING COLOURS



RAW WHITE Similar to RAL 9003

IMPORTANT NOTICES

- JOCAVI[®] accepts no responsibility for any printing errors. Specifications can be modified without prior notice, if technical or commercial reasons so require.
- RAL[®] is an international independent colour standard system partner for industry, trade, architecture and design. Should be consulted before placing any order.
- The colours shown on this catalogue are only a reference and an illustration of the products finishing. The colours shown are not binding because brightness, contrast and colour balance may vary due to the printing process.
- Colours may vary due to raw-material suppliers' changes and some differences may occur in tonal range.
- Typical Indoor Comfort Standards state a temperature range of 20°C - 27°C (68°F - 81°F), and a relative humidity of less than 60%. These would be considered as normal operational levels of JOCAVI[®] products' range.
- Sizes may vary slightly due to their production method and some inherent raw-materials characteristics.



Image of the PETREV06/24 model (on the left) and magnified texture on the background.

DESCRIPTION

This very attractive and decorative acoustic treatment panel for everyday usage. Specially developed as part of the interior design, adequate for the most comfortable workplaces and in public spaces. By using IN PETREV® sound-absorbing materials the airborne noise can be reduced within working spaces and living environment in the greatest extent, especially dealing with the acoustic environment and improving sound intelligibility within the room. IN PETREV® natural fibers are manufactured using high performance recycled polyester fibers by wasting hot pressing process to agglomerate the thickness, shape and density. This line of acoustic panels offer exceptional sound absorption, are thermally bonded for durability, contributing to healthy indoor air quality. Treated with a non-toxic solution that acts as an excellent fire retardant. Actively inhibits, as well, the growth of mildew, mold and bacteria. For walls and ceilings in public spaces and in various types of environments; workspaces, hotels, multi-function halls, conference rooms, gyms, where acoustic and aesthetics performance appeal are important, within a controlled budget. They are available in a several colors. IN PETREV® panels offer high-performance solutions and sustainability to give your project the charming superiority.

FEATURES

- Raw materials: Natural recycled polyester fibre.
- NRC: **0.80/m²** - 24 mm thickness.
- **POLYESTER FIBER** / PET - Class B, EN13501-1:2007 + A1:2009. Fire classification of construction products & building elements. Thermal conductivity [W/(m.K)] 0.039.
- Thermal resistance: [(m².K)/W] 0.254 - EN 12667:2001.
- Very easy to install, mounting glue sold separately.
- 100% recyclable.

TECHNICAL DRAWINGS

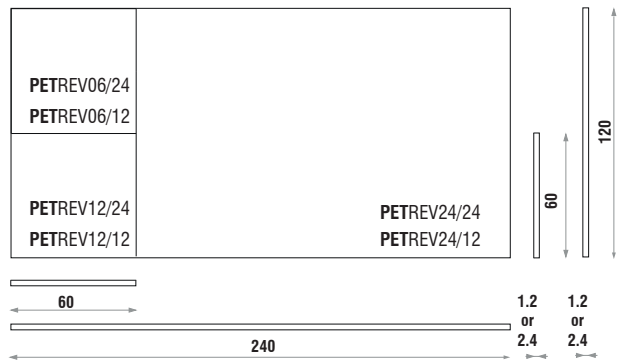

MODELS AND SIZES

MODELS	HEIGHT	WIDTH	DEPTH	WEIGHT
PETREV240	240 cm (94.49 in)	120 cm (47.24 in)	1.2 cm (0.47 in)	6.0 Kg (13.23 lbs)
PETREV120	120 cm (94.49 in)	60 cm (2.36 in)	1.2 cm (0.47 in)	1.5 Kg (3.30 lbs)
PETREV060	60 cm (2.36 in)	60 cm (2.36 in)	1.2 cm (0.47 in)	0.75 Kg (1.65 lbs)

ABSORPTION COEFFICIENT

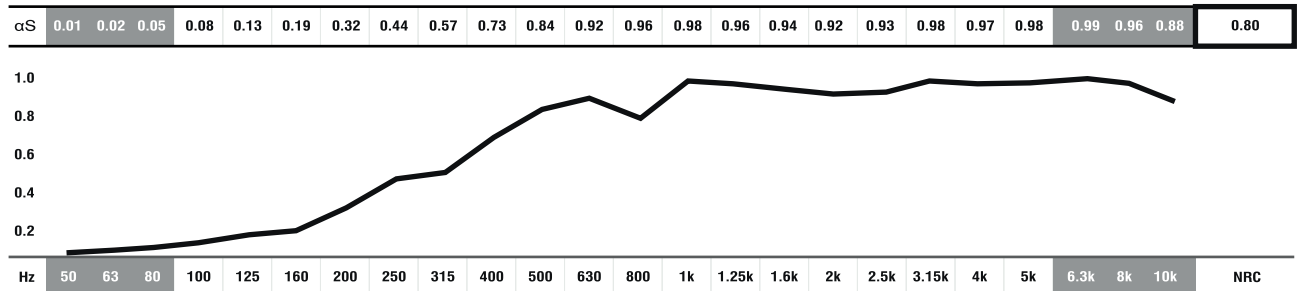

■ ABSORPTION COEFFICIENT: Values in accordance with the standards: EN 20654, ASTM C423 and EN 11654. ■ Values [$<100\text{Hz}$ and $>5\text{K}$] are Non Standard Values.

STANDARD PET COLOURS

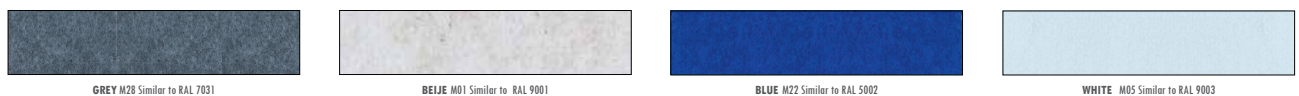

IMPORTANT NOTICES

- JOCANI® accepts no responsibility for any printing errors. Specifications can be modified without prior notice, if technical or commercial reasons so require.
- RAL® is an international independent colour standard system partner for industry, trade, architecture and design. Should be consulted before placing any order.
- The colours shown on this catalogue are only a reference and an illustration of the products finishing. The colours shown are not binding because brightness, contrast and colour balance may vary due to the printing process.
- Colours may vary due to raw-material suppliers' changes and some differences may occur in tonal range.
- Typical Indoor Comfort Standards state a temperature range of 20°C - 27°C (68°F - 81°F), and a relative humidity of less than 60%. These would be considered as normal operational levels of JOCANI® products' range.
- Sizes may vary slightly due to their production method and some inherent raw-materials characteristics.



SEAFOAM® / SEAFOAM® FL

ABSORBENT PANEL

**NEW
UPDATED
MODELS**

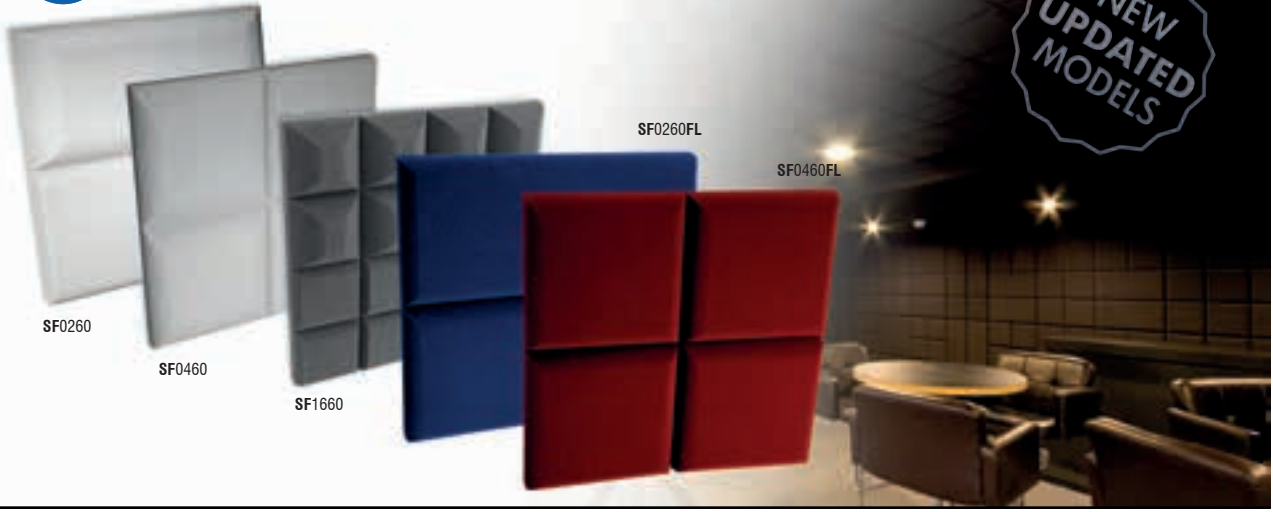

Image of 60x60cm models Ref.:SF0260, Ref.:SF0460 and Ref.:SF1660, and the new SEAFOAM®FL, Ref.:SF0260FL, Ref.:SF0460FL (on the left) and Ref.:SF0260 Velvety Finishing applied (ambient image).

DESCRIPTION

The SEAFOAM® is made of a flexible open-cell foam from melamine resin, a thermoset polymer. This foam is characterised by its three-dimensional network structure which consists of easily shaped thin filaments. The sound waves penetrate the open-cell structure, thus reducing the reflected energy and giving this product an excellent sound absorption capacity.

Due to its low weight, the SEAFOAM® allows the creation of large-surface elements that seem to be free-floating, giving rooms an attractive appearance. The simple installation method does not require any additional structural or engineering calculations. Working areas which are exposed to high levels of noise, such as industrial areas, pavilions, among others, can be acoustically restored at a low cost, by reequipping them with these lightweight absorbers. We can make specific shapes and sizes for large projects upon demand. The SEAFOAM®'s acoustic and safety characteristics make this product ideal for use as a noise control and sound insulation device in buildings that have demanding requirements against fire. It improves acoustics and soundproofing, thereby providing safety in accordance with environmental standards.

FEATURES

- Raw material: Melamine Foam or Regular Acoustic Foam.
- NRC: **0.80/m²**.
- **MELAMINE FOAM** - Flame resistance: Euroclass B-s1,d0, France M1 Germany B1,GB class1, USA V0/HF1).
- **ACOUSTIC FOAM** - Flame resistance: Euroclass B-s3,d1, Self-extinguishable M1 fire-retardant foam.
- Good thermal insulation properties and humidity tolerance.
- Constant physical properties over a wide temperature range
- Resistance to all organic solvents. 100% recyclable.
- Velvety Finishing available.
- Very easy to install, mounting: with glue (sold separately)

ABSORPTION COEFFICIENT*

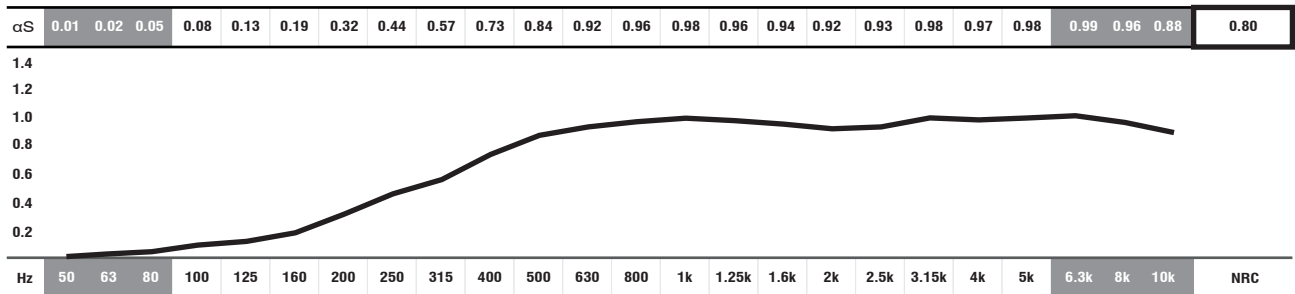

■ ABSORPTION COEFFICIENT: Values in accordance with the standards: EN 20654, ASTM C423 and EN 11654.

■ Values [$<100\text{Hz}$ and $>5\text{K}$] are Non Standard Values.
*PANEL DATA ONLY OF REF: SF0460 (8 CM) REGULAR FOAM.

TECHNICAL DRAWINGS

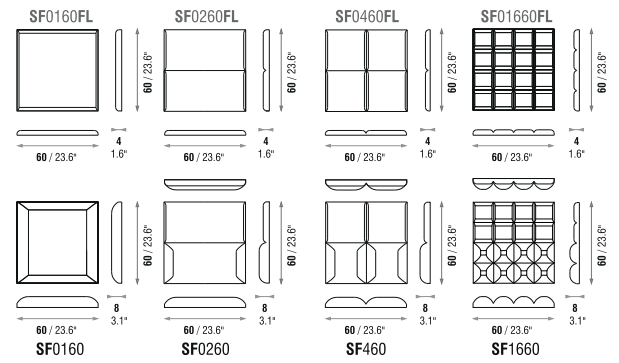

MODELS AND SIZES

MODELS	HEIGHT	WIDTH	DEPTH	WEIGHT
SF0160	60 cm (23.6 in)	60 cm (23.6 in)	8 cm (3.1 in)	0.6 Kg (1.32 lbs)
SF0260	60 cm (23.6 in)	60 cm (23.6 in)	8 cm (3.1 in)	0.6 Kg (1.32 lbs)
SF0460	60 cm (23.6 in)	60 cm (23.6 in)	8 cm (3.1 in)	0.6 Kg (1.32 lbs)
SF1660	60 cm (23.6 in)	60 cm (23.6 in)	8 cm (3.1 in)	0.6 Kg (1.32 lbs)
SF0160FL	60 cm (23.6 in)	60 cm (23.6 in)	4 cm (1.6 in)	0.35 Kg (0.77 lbs)
SF0260FL	60 cm (23.6 in)	60 cm (23.6 in)	4 cm (1.6 in)	0.35 Kg (0.77 lbs)
SF0460FL	60 cm (23.6 in)	60 cm (23.6 in)	4 cm (1.6 in)	0.35 Kg (0.77 lbs)
SF1660FL	60 cm (23.6 in)	60 cm (23.6 in)	4 cm (1.6 in)	0.35 Kg (0.77 lbs)

REGULAR AND MELAMINE FOAM COLOURS



VELVETY FINISHINGS (only available in Melamine Foam)



IMPORTANT NOTICES

- JOCAVI® accepts no responsibility for any printing errors. Specifications can be modified without prior notice, if technical or commercial reasons so require.
- The colours shown on this catalogue are only a reference and an illustration of the products finishing. The colours shown are not binding because brightness, contrast and colour balance may vary due to the printing process.
- Colours may vary due to raw-material suppliers' changes and some differences may occur in tonal range.
- Typical Indoor Comfort Standards state a temperature range of 20°C - 27°C (68°F - 81°F), and a relative humidity of less than 60%. These would be considered as normal operational levels of JOCAVI® products' range.
- Despite all the standard sizes of all products, this model can be customised upon previous consultation. Sizes may vary slightly due to their production method and some inherent raw-materials characteristics.



SNOWSORB® ABSORBENT PANEL

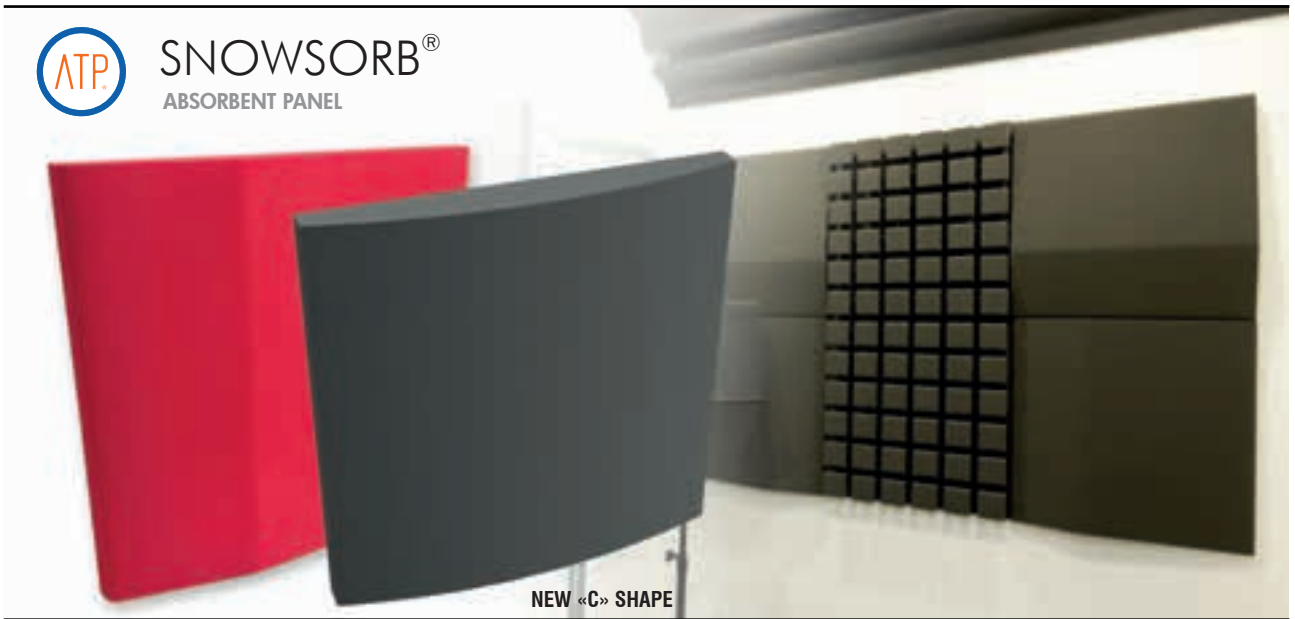

NEW «C» SHAPE

Image of 60x60cm model Ref.:SNW060 (on the left) and Ref.:SNW060 applied (ambient image).

DESCRIPTION

In order to expand the range of options available on absorption panels, ATP® created the SNOWSORB® with an attractive shape. This model can also be used as a soundproofing reinforcement material.

This panel has a simple aesthetic format that allows various different combinations. It is ideal to be mounted on walls and ceilings, on continuous surfaces or selected spots by combining it with other models.

It is made of regular acoustic foam or of melamine foam as an option.

Commercial areas, Television studios, Pavilions, auditoriums, meeting rooms, public spaces, etc., need specific care regarding airborne noise control. The creation of surfaces that are efficient at absorbing sound waves becomes imperative, and that is the main feature that makes this product so relevant.

Due to its high absorption coefficient and low cost, the SNOWSORB® is specifically recommended product for the acoustic treatment of large areas. It can be easily cut with a sharp utility knife to be adjusted to the dimensions of walls and ceilings.

FEATURES

- Raw material: Melamine Foam or Regular Acoustic Foam.
- NRC: **0.90/m²** [$>250\text{Hz}; <10\text{KHz}$].
- **MELAMINE FOAM** - Flame resistance: Euroclass B-s1,d0 (similar to old M1 France, Germany B1,GB class1, USA V0/HF1).
- **ACOUSTIC FOAM** - Flame resistance: Euroclass B-s3,d1 (similar to old M1).
- Velvety Finishing available.
- Very easy to install.
- 100% recyclable.

TECHNICAL DRAWINGS

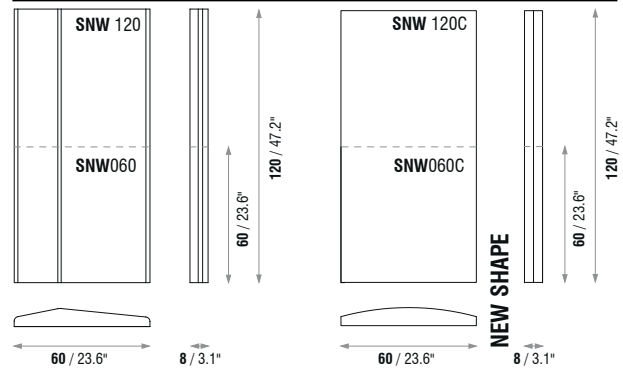

MODELS AND SIZES

MODELS	HEIGHT	WIDTH	DEPTH	WEIGHT
SNW120	120 cm (47.2 in)	60 cm (23.6 in)	8 cm (3.1 in)	1.2 Kg (2.65 lbs)
SNW060	60 cm (23.6 in)	60 cm (23.6 in)	8 cm (3.1 in)	0.6 Kg (1.32 lbs)
SNW120C	120 cm (47.2 in)	60 cm (23.6 in)	8 cm (3.1 in)	1.2 Kg (2.65 lbs)
SNW060C	60 cm (23.6 in)	60 cm (23.6 in)	8 cm (3.1 in)	0.6 Kg (1.32 lbs)

ABSORPTION COEFFICIENT

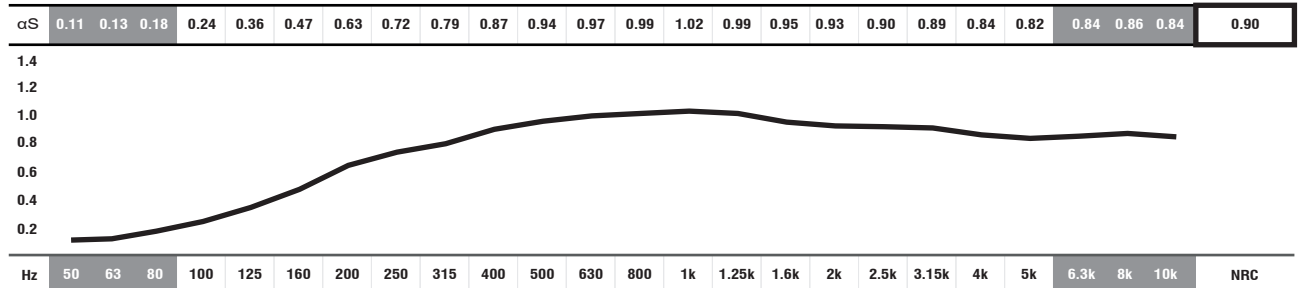

■ ABSORPTION COEFFICIENT: Values in accordance with the standards: EN 20654, ASTM C423 and EN 11654.

■ Values [$<100\text{Hz}$ and $>5\text{K}$] are Non Standard Values.

REGULAR AND MELAMINE FOAM COLOURS



VELVETY FINISHINGS (only available in Melamine Foam)

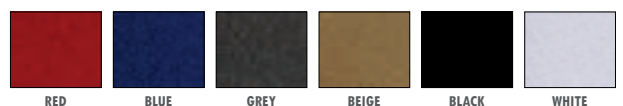

IMPORTANT NOTICES

- JOCAVI® accepts no responsibility for any printing errors. Specifications can be modified without prior notice, if technical or commercial reasons so require.
- The colours shown on this catalogue are only a reference and an illustration of the products finishing. The colours shown are not binding because brightness, contrast and colour balance may vary due to the printing process.
- Colours may vary due to raw-material suppliers' changes and some differences may occur in tonal range.
- Typical Indoor Comfort Standards state a temperature range of 20°C - 27°C (68°F - 81°F), and a relative humidity of less than 60%. These would be considered as normal operational levels of JOCAVI® products' range.
- Despite all the standard sizes of all products, this model can be customised upon previous consultation. Sizes may vary slightly due to their production method and some inherent raw-materials characteristics.



STRIPESORB® / STRIPESORB ARC®

ABSORBENT PANEL



Image of pair of the 60x60cm model Ref.:STS060A and Ref.:STS120A applied (ambient image) on the left part.

Image of 60x60cm model Ref.:STS060 (cream foam) and Ref.:STS120 applied (ambient image on the right).

DESCRIPTION

The STRIPESORB® is a stripe-shaped acoustic treatment absorber made of self-extinguishing acoustic foam.

Its shape looks similar to parallel blades with angular spaces between them. It was designed in order to have small longitudinal absorption surfaces separated by small angled incisions; its shape maximizes the area that is exposed to the sound waves for better absorption.

There are two different shapes, STRIPESORB®, which is flat, and STRIPESORB ARC®, which describes a concave and convex arc that wave uniformly, these can be combined to offer different decorative alternatives.

It is meant to achieve a great absorption for the budget-conscious acoustic projects. Installed by gluing it directly to the existing surface with our recommended adhesives.

The STRIPESORB® is recommended for project spaces, large room environments, common workspaces, music studios, listening rooms, as well as small booths. This model can be applied on large continuous areas when mandatory and stronger acoustic absorption is required, by solving excessive reverberation problems as well as flutter echo problems.

FEATURES

- Raw material: Melamine Foam or Regular Acoustic Foam.
- NRC: **0.81/m²** [$>250\text{Hz}; <10\text{KHz}$].
- **MELAMINE FOAM** - Flame resistance: Euroclass B-s1,d0 (similar to old M1 France, Germany B1,GB class1, USA V0/HF1).
- **ACOUSTIC FOAM** - Flame resistance: Euroclass B-s3,d1 (similar to old M1).
- Standard Dimensions: 60x60x11cm and 120x60x11cm, **STS120A** and **STS060A**.
- Shape and design recommended for continuous surface treatment.
- Sold in pairs (**STS120A** and **STS060A** models).
- Very easy to install.

TECHNICAL DRAWINGS

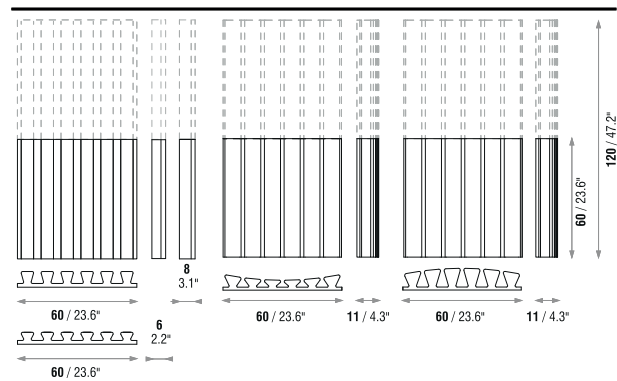

MODELS AND SIZES

MODELS	HEIGHT	WIDTH	DEPTH	WEIGHT
■ STS120	120 cm (47.2 in)	60 cm (23.6 in)	8 cm (3.1 in)	0.8 Kg (1.76 lbs)
■ STS060	60 cm (23.6 in)	60 cm (23.6 in)	8 cm (3.1 in)	0.4 Kg (0.88 lbs)
□ STS120/6	120 cm (47.2 in)	60 cm (23.6 in)	6 cm (2.2 in)	0.6 Kg (1.32 lbs)
□ STS060/6	60 cm (23.6 in)	60 cm (23.6 in)	6 cm (2.2 in)	0.6 Kg (1.32 lbs)
■ STS120A*	120 cm (47.2 in)	60 cm (23.6 in)	11 cm (4.3 in)	0.8 Kg (1.76 lbs)
■ STS060A*	60 cm (23.6 in)	60 cm (23.6 in)	11 cm (4.3 in)	0.4 Kg (0.88 lbs)

***SOLD IN PAIRS**

ABSORPTION COEFFICIENT

α_S	0.08	0.08	0.12	0.18	0.25	0.34	0.44	0.55	0.64	0.74	0.79	0.80	0.80	0.75	0.70	0.70	0.75	0.83	0.90	0.96	0.97	0.98	0.96	0.97	0.81
α_S	0.07	0.08	0.11	0.14	0.21	0.28	0.37	0.52	0.70	0.74	0.82	0.88	0.88	0.88	0.88	0.97	1.02	1.04	1.02	1.02	0.99	0.97	0.96	0.95	0.81

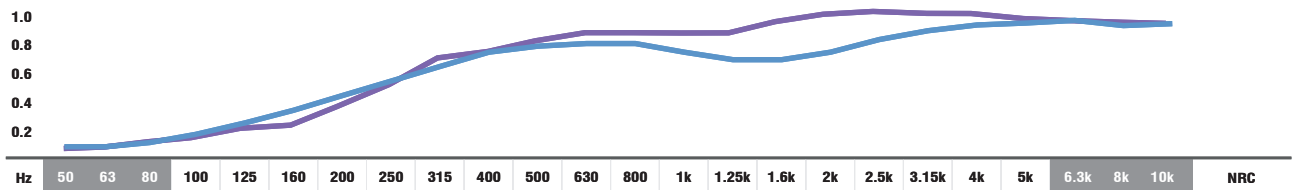

■ ■ ABSORPTION COEFFICIENT: Values in accordance with the standards: EN 20654, ASTM C423 and EN 11654.

■ Values [$<100\text{Hz}$ and $>5\text{K}$] are Non Standard Values.

REGULAR AND MELAMINE FOAM COLOURS

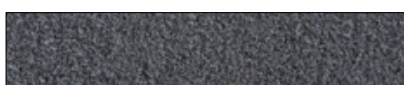

GREY
Regular foam

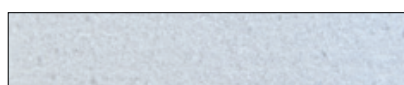

LIGHT GREY
Melamine Foam

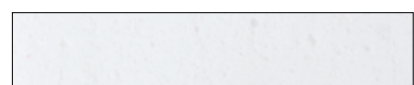

WHITE
Melamine Foam

IMPORTANT NOTICES

- JOCAVI® accepts no responsibility for any printing errors. Specifications can be modified without prior notice, if technical or commercial reasons so require.
- The colours shown on this catalogue are only a reference and an illustration of the products finishing. The colours shown are not binding because brightness, contrast and colour balance may vary due to the printing process.
- Colours may vary due to raw-material suppliers' changes and some differences may occur in tonal range. Close attention must be paid to the storage conditions and the acclimatization before, during and after the installation.
- Typical Indoor Comfort Standards state a temperature range of 20°C - 27°C (68°F - 81°F), and a relative humidity of less than 60%. These would be considered as normal operational levels of JOCAVI® products' range.
- Despite all the standard sizes of all products, this model can be customised upon previous consultation. Sizes may vary slightly due to their production method and some inherent raw-materials characteristics.



SWELL® ABSORBENT PANEL

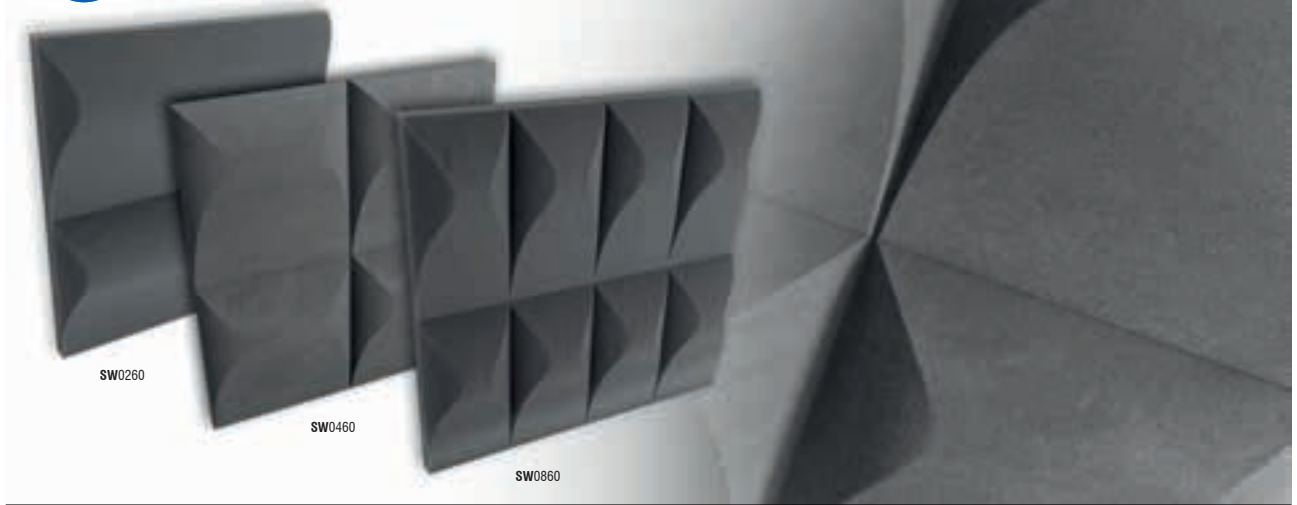

Image of 60x60cm models Ref.:SW0260, Ref.:SW0460 and Ref.:SW0860 (on the left) and Ref.:SW0460 applied (ambient image).

DESCRIPTION

The SWELL® model is an absorbent panel made of self-extinguishing acoustic foam or melamine foam as an option, thus meeting the highest fire protection requirements. We recommend this model for lining the continuous surfaces of walls and ceilings, which enables a high absorption coefficient and an important sound insulation as well.

The SWELL® can be used as a sound barrier and airborne noise reduction for various types of rooms: commercial areas, television studios, pavilions, auditoriums, meeting rooms, public spaces, etc..

It is a very functional and decorative finishing that meets the performance and aesthetic attributes. Several aesthetic combinations are possible by turning the panel by 90 degrees. It can be easily cut with a knife to be adjusted to the dimensions of walls and ceilings.

TECHNICAL DRAWINGS

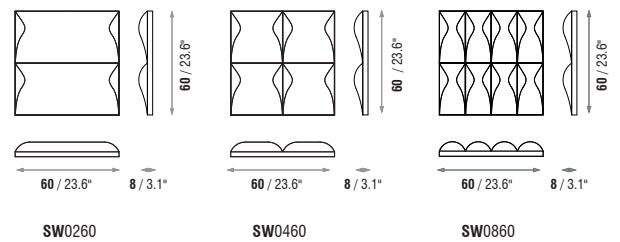

FEATURES

- Raw material: Melamine Foam or Regular Acoustic Foam.
- NRC: **0.90/m²** [$>250\text{Hz}$; $<10\text{kHz}$].
- **MELAMINE FOAM** - Flame resistance: Euroclass B-s1,d0 (similar to old M1 France, Germany B1,GB class1, USA V0/HF1).
- **ACOUSTIC FOAM** - Flame resistance: Euroclass B-s3,d1 (similar to old M1).
- Velvety Finishing available.
- Very easy to install.
- 100% recyclable.

MODELS AND SIZES

MODELS	HEIGHT	WIDTH	DEPTH	WEIGHT
SW0260	60 cm (23.6 in)	60 cm (23.6 in)	8 cm (3.1 in)	0.6 Kg (1.32 lbs)
SW0460	60 cm (23.6 in)	60 cm (23.6 in)	8 cm (3.1 in)	0.6 Kg (1.32 lbs)
SW0860	60 cm (23.6 in)	60 cm (23.6 in)	8 cm (3.1 in)	0.6 Kg (1.32 lbs)

ABSORPTION COEFFICIENT*

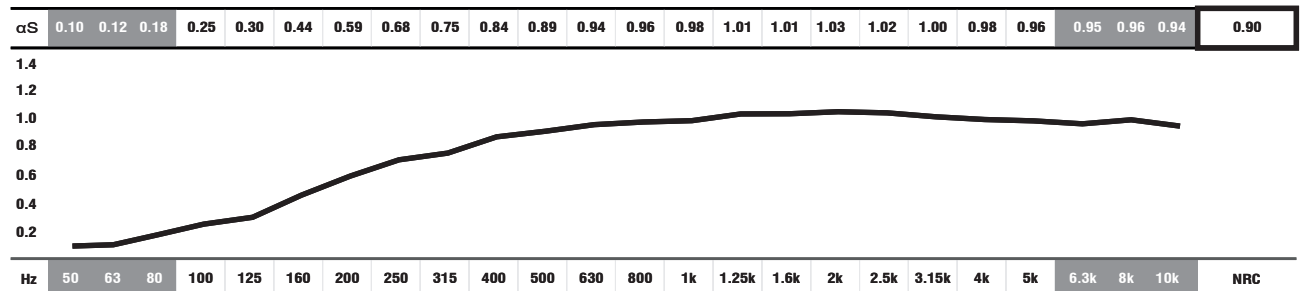

■ ABSORPTION COEFFICIENT: Values in accordance with the standards: EN 20654, ASTM C423 and EN 11654.

■ Values [$<100\text{Hz}$ and $>5\text{K}$] are Non Standard Values.

*PANEL DATA ONLY OF REF.: SW0460 REGULAR FOAM.

REGULAR AND MELAMINE FOAM COLOURS



VELVETY FINISHINGS (only available in Melamine Foam)

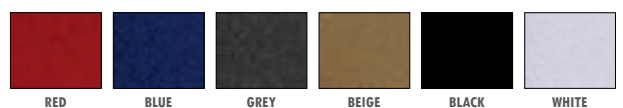

IMPORTANT NOTICES

- JOCAVI® accepts no responsibility for any printing errors. Specifications can be modified without prior notice, if technical or commercial reasons so require.
- The colours shown on this catalogue are only a reference and an illustration of the products finishing. The colours shown are not binding because brightness, contrast and colour balance may vary due to the printing process.
- Colours may vary due to raw-material suppliers' changes and some differences may occur in tonal range.
- Typical Indoor Comfort Standards state a temperature range of 20°C - 27°C (68°F - 81°F), and a relative humidity of less than 60%. These would be considered as normal operational levels of JOCAVI® products' range.
- Despite all the standard sizes of all products, this model can be customised upon previous consultation. Sizes may vary slightly due to their production method and some inherent raw-materials characteristics.



WUSORBER®

ABSORBENT PANEL



WOOD

Image of model Ref.:WUS120 (on the left) and applied (ambient image).

DESCRIPTION

WUSORBER® represents the evolution of architectural acoustics for the sequencing of asymmetric forms of surfaces. This acoustic trap has an open resonance box with Projected Cellulose finishing and can be aesthetically matched with both the BASSKEEPER WALL® and BASSKEEPER ANGLE®.

Due to its shallower profile shape and coating, the WUSORBER® provides a uniform sound field throughout mid and high frequency sound diffusion, while limiting the amount of medium-low frequencies sound absorption derived from the open resonance box.

The performance of this product is even more advanced when several units are installed together on one surface. A sequence of these mounted in array, takes advantage of the aperiodic and asymmetric form of the WUSORBER® to minimize the effects of lobbing caused by the simple and flat forms, that is, symmetrical and periodic forms.

TECHNICAL DRAWINGS

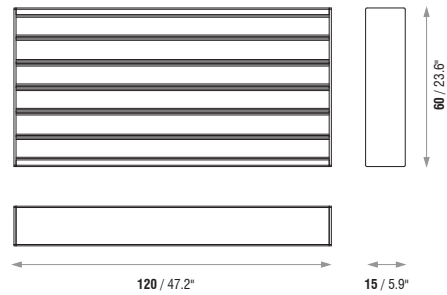

FEATURES

- NRC: **0.73/m²** [$>250\text{Hz}; <1\text{KHz}$].
- Peak Absorbent Frequency: 250Hz.
- Raw material: HD EPS with Coloured Projectable Cellulose Finishing.
- Fire-resistance: Projectable Cellulose - Euroclass A2-s1,d0 (similar to old M0);
- Fire-resistance: EPS - Euroclass B-s3,d1 (similar to old M1).
- Application on walls and ceilings, can be suspended with accessories.
- Very easy to install.
- Other colours available upon consultation.

MODELS AND SIZES

MODELS	HEIGHT	WIDTH	DEPTH	WEIGHT
WUS120	120 cm (47.2 in)	60 cm (23.6 in)	15 cm (5.9 in)	3.1 Kg (6.83 lbs)

ABSORPTION COEFFICIENT

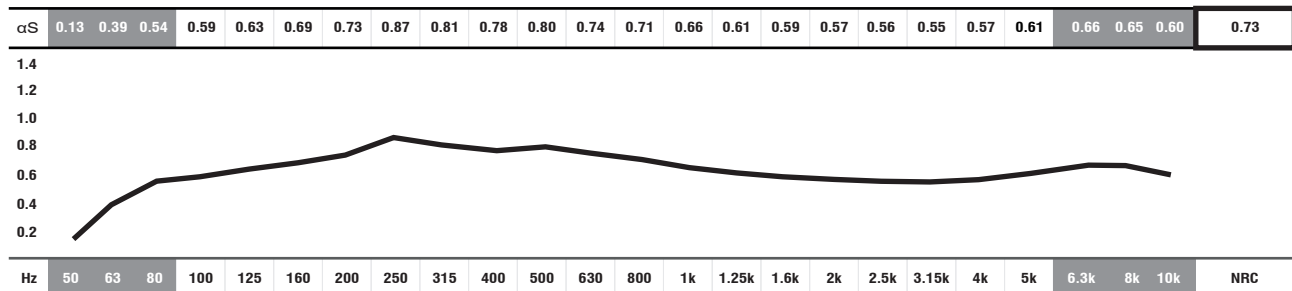

■ ABSORPTION COEFFICIENT: Values in accordance with the standards: EN 20654, ASTM C423 and EN 11654.

■ Values [$<100\text{Hz}$ and $>5\text{K}$] are Non Standard Values.

STANDARD PROJECTABLE CELLULOSE FINISHING COLOURS

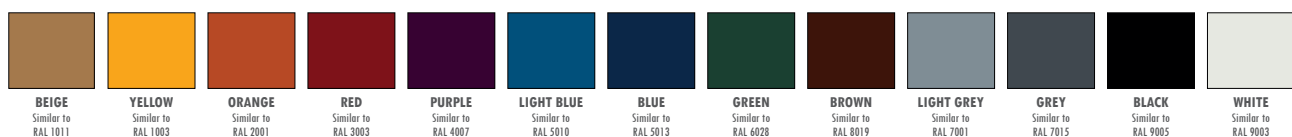

IMPORTANT NOTICES

- JOCAVI® accepts no responsibility for any printing errors. Specifications can be modified without prior notice, if technical or commercial reasons so require.
- RAL® is an international independent colour standard system partner for industry, trade, architecture and design. Should be consulted before placing any order.
- The colours shown on this catalogue are only a reference and an illustration of the products finishing. The colours shown are not binding because brightness, contrast and colour balance may vary due to the printing process.
- Colours may vary due to raw-material suppliers' changes and some differences may occur in tonal range.
- Typical Indoor Comfort Standards state a temperature range of 20°C - 27°C (68°F - 81°F), and a relative humidity of less than 60%. These would be considered as normal operational levels of JOCAVI® products' range.
- Sizes may vary slightly due to their production method and some inherent raw-materials characteristics.



WATERCOT®

ABSORBENT PANEL - SUSPENDED AND WALL PANELS



WATERCOT® WAL
REF: WAW120

WATERCOT® BAF
REF: WAB120



WAB120



WAW120

Image of Watercot® models Ref.:WAW120 (on the left) and Ref.:WAB120 models. Watercot® WAL model (ambient image).

DESCRIPTION

This model comes in two versions: the WATERCOT®BAF, which is a suspension baffle for ceilings, and the WATERCOT®WAL, which is a covering material for walls and ceilings. The latter is provided with its own glue, a self-adhesive film, and it is very easily applied.

The WATERCOT® is manufactured with one component only, i.e., closed-cell polyethylene foam, whose cells are open by perforation at a later process during manufacture. The result is a very efficient material for acoustic treatment.

The several advantages of this product are its weight, price, durability and moisture resistance. When compared to other similar materials, i.e., polyester-foam and melamine-foam, this material has distinct advantages which allow its use in rather wet environments and outdoors, given its resistance to moisture and water.

One of the key features of this foam is actually its capacity to remain physically and acoustically unchanged when exposed to water and moisture.

These two products, the WATERCOT®WAL and the WATERCOT®BAF, are yet another option of acoustic treatment provided by JOCAVI®, mainly when both moisture and fire resistance requirements are essential criteria. It is a mandatory tool for airborne noise control problems and a very low-cost solution.

FEATURES

- Raw material: PE Foam.
- Excellent acoustic properties NRC: (Watercot® WAL - 0.82/m²) and (Watercot® BAF - 0.86/m²).
- Flame resistance: Euroclass B (similar to old M1 France, B1 Class (DIN 4102), GB class1, VO/HF1 (UL94). Meets all fire policies required for the Building & Construction. No volatile mineral fibres.
- It withstands the direct contact with water and may be washed by water pressure.
- Water absorption: %Vol. (28d-95%HR) < 4 %vol. Density: 30kg/m³
- Low average weight that allows light fastening structures.
- Easy installation: **Self-adhesive Watercot® WAL and Watercot® BAF suspension panel.**

TECHNICAL DRAWINGS

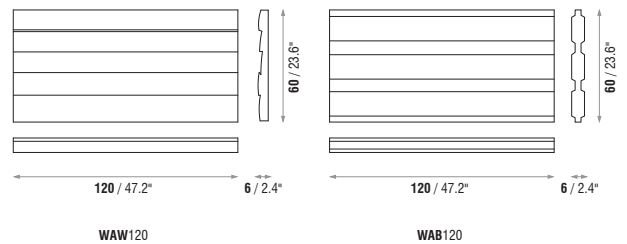

MODELS AND SIZES

MODELS	HEIGHT	WIDTH	DEPTH	WEIGHT
WAW120	120 cm (47.2 in)	60 cm (23.6 in)	6 cm (2.4 in)	0.46 Kg (1.01 lbs)
WAB120	120 cm (47.2 in)	60 cm (23.6 in)	6 cm (2.4 in)	0.44 Kg (0.97 lbs)

ABSORPTION COEFFICIENT

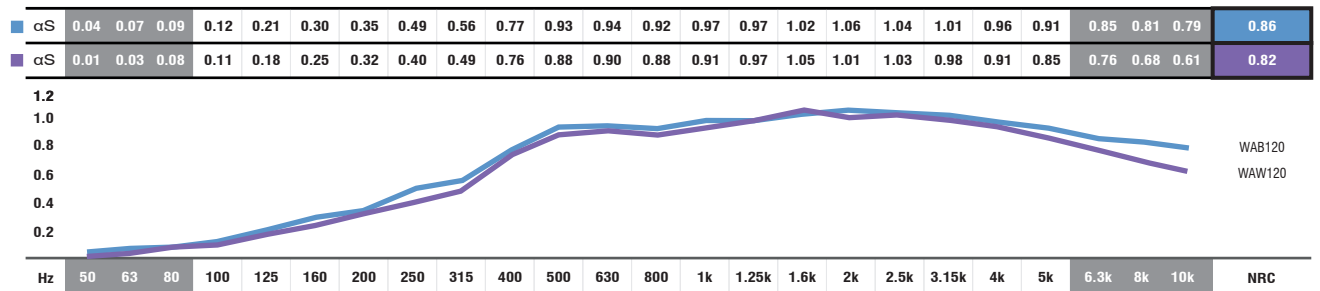

ABSORPTION COEFFICIENT: Values in accordance with the standards: EN 20654, ASTM C423 and EN 11654.

- Watercot® BAF model: values obtained with one panel per m², suspended from the ceiling.
- Watercot® WAL model: values obtained with one panel per m², with the product glued to a concrete wall.

STANDARD COLOURS



WHITE



BLACK

IMPORTANT NOTICES

- JOCAVI® accepts no responsibility for any printing errors. Specifications can be modified without prior notice, if technical or commercial reasons so require.
- The colours shown on this catalogue are only a reference and an illustration of the products finishing. The colours shown are not binding because brightness, contrast and colour balance may vary due to the printing process.
- Colours may vary due to raw-material suppliers' changes and some differences may occur in tonal range.
- Typical Indoor Comfort Standards state a temperature range of 20°C - 27°C (68°F - 81°F), and a relative humidity of less than 60%. These would be considered as normal operational levels of JOCAVI® products' range.
- Despite all the standard sizes of all products, this model can be customised upon previous consultation. Sizes may slightly vary due to their production method and some inherent raw-materials characteristics. . .



WIDEBAFFLE®

ABSORBENT PANEL



WBF120

WLS120

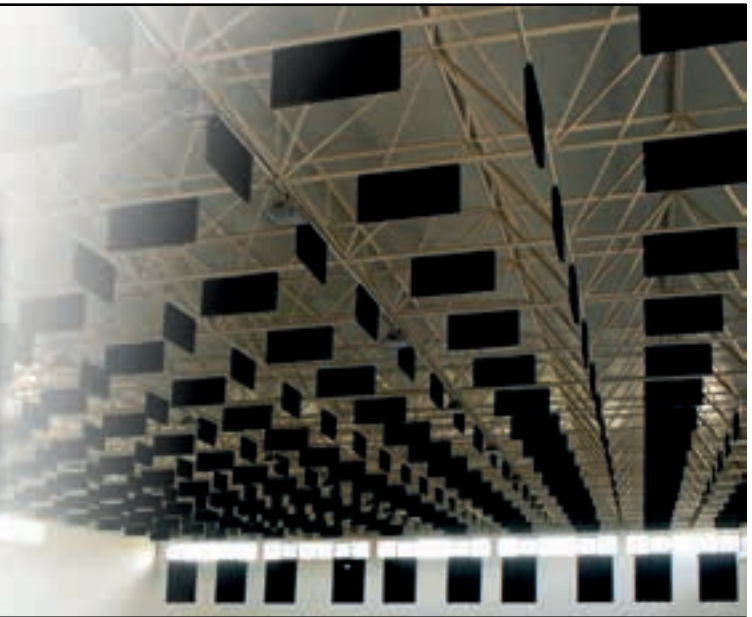

Image of 120x60cm models Ref.:WBF120 and Ref.:WLS120 (on the left) and Ref.:WBF120 applied (ambient image).

DESCRIPTION

WIDEBAFFLE® is our acoustic baffle to be applied in large rooms. This baffle is ideal to reduce reverberation time and airborne noise in gyms, pools, cafeterias, churches, schools, nightclubs, metal buildings and multipurpose rooms. It is a mandatory tool for airborne noise control problems and a very low cost solution.

The WIDEBAFFLE® is easy to install and can be assembled in very different aesthetic combinations. These sound baffles are typically suspended from the ceiling, and may also be used as acoustic wall panels, helping decrease the reflected sound energy.

Also available other model with the same efficiency but with a different design, the WIDEBAFFLE® LS (WLS120).

TECHNICAL DRAWINGS

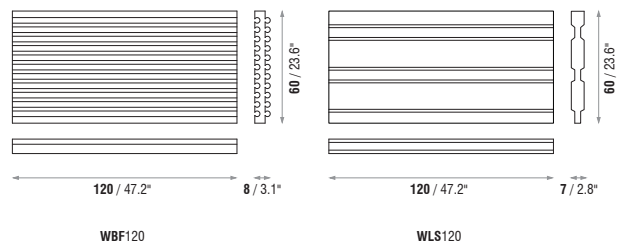

FEATURES

- Raw material: Melamine Foam or Regular Acoustic Foam.
- NRC: **0.87/m²** [$>250\text{Hz}; <10\text{KHz}$].
- **MELAMINE FOAM** - Flame resistance: Euroclass B-s1,d0 (similar to old M1 France, Germany B1,GB class1, USA V0/HF1).
- **ACOUSTIC FOAM** - Flame resistance: Euroclass B-s3,d1 (similar to old M1).
- Very easy to install.
- 100% recyclable.

MODELS AND SIZES

MODELS	HEIGHT	WIDTH	DEPTH	WEIGHT
WBF120	120 cm (47.2 in)	60 cm (23.6 in)	8 cm (3.1 in)	1.1 Kg (2.43 lbs)
WLS120	120 cm (47.2 in)	60 cm (23.6 in)	7 cm (2.8 in)	1 Kg (2.20 lbs)

ABSORPTION COEFFICIENT

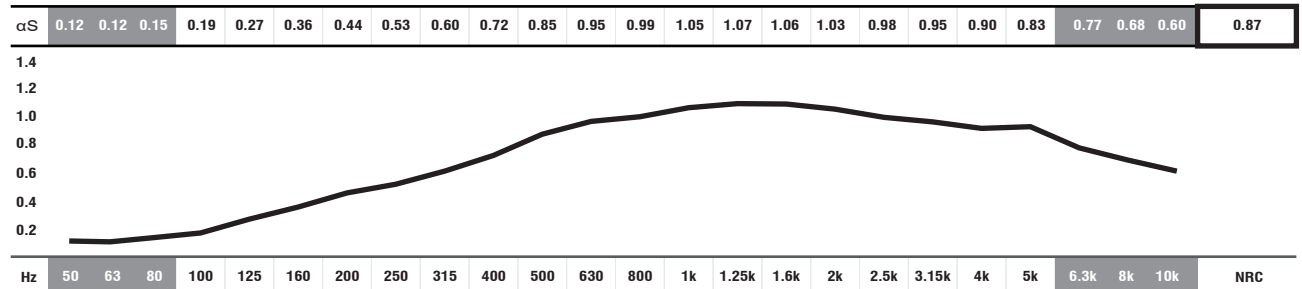

■ ABSORPTION COEFFICIENT: Values in accordance with the standards: EN 20654, ASTM C423 and EN 11654.

■ Values [$<100\text{Hz}$ and $>5\text{K}$] are Non Standard Values.

*PANEL DATA ONLY OF REF.: WBF120 REGULAR FOAM.

REGULAR AND MELAMINE FOAM COLOURS



GREY
Regular foam



LIGHT GREY
Melamine Foam

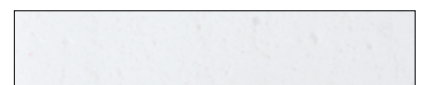

WHITE
Melamine Foam

IMPORTANT NOTICES

- JOCAVI® accepts no responsibility for any printing errors. Specifications can be modified without prior notice, if technical or commercial reasons so require.
- The colours shown on this catalogue are only a reference and an illustration of the products finishing. The colours shown are not binding because brightness, contrast and colour balance may vary due to the printing process.
- Colours may vary due to raw-material suppliers' changes and some differences may occur in total range. Close attention must be paid to the storage conditions and the acclimatization before, during and after the installation.
- Typical Indoor Comfort Standards state a temperature range of 20°C - 27°C (68°F - 81°F), and a relative humidity of less than 60%. These would be considered as normal operational levels of JOCAVI® products' range.
- Despite all the standard sizes of all products, this model can be customised upon previous consultation. Sizes may vary slightly due to their production method and some inherent raw-materials characteristics.



ASSC®

ART OF SILENCE - SUSPENDED CEILING



Image of 60x60cm models (on the left) and one of the model applied (ambient image).

DESCRIPTION

Creating a clean linear effect on ceilings and walls across a range of applications, these panels style offer a warm organic finish, ideally suited to use in lecture theatres, meeting rooms and public buildings.

Sound absorption is a critical component of every room that will be occupied and used by people. Evaluating the performance of the acoustic drop ceiling systems, you'll want to reference two general ratings: Noise Reduction Coefficient (NRC), *thereby lessening the noise within a room*; and Ceiling Attenuation Class (CAC), *meaning how much sound travels to adjacent rooms*;

Ceiling panels must serve to absorb and control the noise inside the room as well as preventing it from bouncing off surfaces and spreading throughout the spaces around and down corridors causing unwanted disruptions.

Most of the drop ceilings are not effective at blocking sound because they lightweight. Our ASSC T-System plates are made of two components and have larger mass, therefore they offer higher NRC and CAC values than the other competitor products.

Discover the ASSC T-System range of acoustic ceiling treatments. Cover large areas to transform the aesthetics and acoustics of the space and turn into a beautiful and quiet place.

Explore your interior horizon with ASSC T-System. We have at your disposal three types of plates with different finishes; pressed granulated minerals + melamine foam, natural wood + coconut fibre and Polyester fibre (PET) + fabric. Several aesthetic options, several colours, perforations and three different textures available.

Assembly is as simple as placing the acoustic plate on the standard metal profile. These plates are universally applicable to any (T type) metal profile for drop ceilings, however it is necessary to create previously a suspended structure in metal profile (T-grid) to apply the acoustic plates, whilst allowing access to the ceiling above.

ASSC T-System plates can also be applied to walls with the help of our profile ABCP that is available as an accessory.

These plates are acoustically tested in two ways; leaning against a surface as a coating and settling to a surface suspended in the ceiling creating an air box. The plates have a better sound absorption performance when suspended in the ceiling.

For large rooms, public spaces, or any room where noise is an issue, ASSC T-System acoustic drop ceiling plates can help absorb airborne noise and reduce reverberation, preventing sound from traveling to adjacent rooms. Here's how to make sense of acoustic ratings and what they mean for noise control in your environment.

MODELS AND SIZES

MODELS	HEIGHT	WIDTH	DEPTH	WEIGHT
WBA060TC	60 cm (23.6 in)	60 cm (23.6 in)	2,0 cm (0.79 in)	3,3 Kg (7.28 lbs)
ADD060TC	60 cm (23.6 in)	60 cm (23.6 in)	2,8 cm (1.1 in)	4,4 Kg (9.70 lbs)
ABCoat060TC	60 cm (23.6 in)	60 cm (23.6 in)	4 cm (1.6 in)	0,2 Kg (0.44 lbs)

SCHEMATIC DRAWINGS

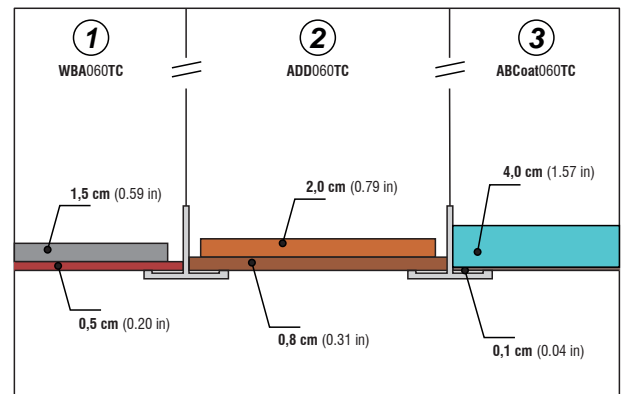
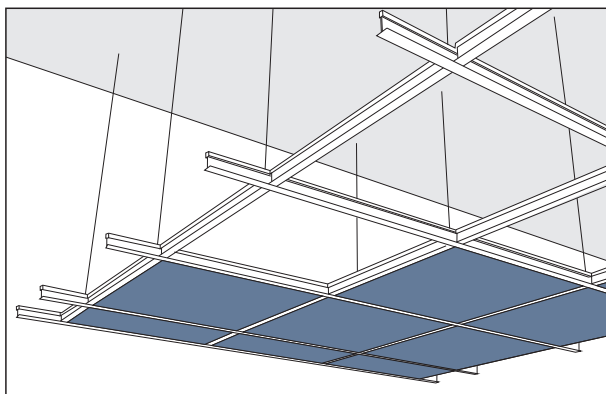

MINERAL GRANULATED COLOURS

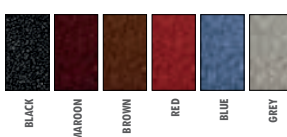

WOOD VENEER FINISHINGS

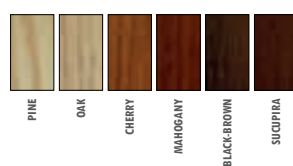

STANDARD FABRIC COLOURS

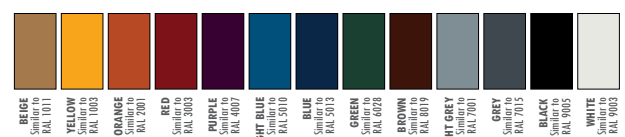

• JOCAVI® accepts no responsibility for any printing errors. Specifications can be modified without prior notice, if technical or commercial reasons so require.
 • RAL® is an international independent colour standard system partner for industry, trade, architecture and design. Should be consulted before placing any order.
 • The colours shown on this catalogue are only a reference and an illustration of the products finishing. The colours shown are not binding because brightness, contrast and colour balance may vary due to the printing process.
 • Colours may vary due to raw-material suppliers' changes and some differences may occur in tonal range.
 • Sizes may vary slightly due to their production method and some inherent raw-materials characteristics.

① STAIDTREAT® PLATE

ABSORPTION COEFFICIENT

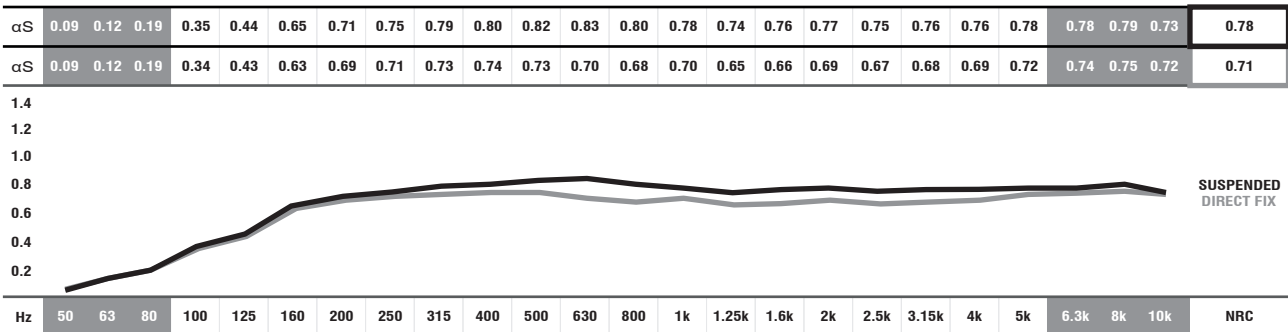

■ ABSORPTION COEFFICIENT: Values in accordance with the standards: EN 20654, ASTM C423 and EN 11654. ■ Values [$<100\text{Hz}$ and $> 5\text{K}$] are Non Standard Values.

FEATURES

- STYLE: Square acoustic plates that provide sound absorption for health care, education and open plan rooms.
- COMPOSITION: Pressed granulated minerals + melamine foam.
- THICKNESS: 20 mm (+/- 2 mm tolerance) / 0.79" (+/- 0.1" tolerance).
- AVAILABLE SIZES: 600mm x 600mm x 20mm / (23.6" x 23.6" x 0.79").
- WEIGHT: 8,4 Kg/m² (18,52 Lbs/ ft²).
- NOISE REDUCTION COEFFICIENT (NRC) - Direct Fix to ceiling: **0.71/m²**;
- suspended 200mm from ceiling: **0.78/m²**.
- FIRE RATING: Class 0 (BS 5422:1990).

② ADDSORB® PLATE

ABSORPTION COEFFICIENT

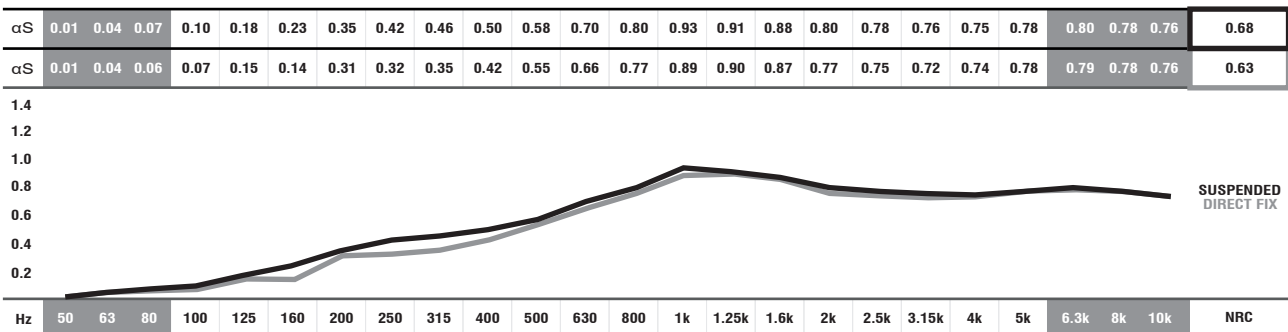

■ ABSORPTION COEFFICIENT: Values in accordance with the standards: EN 20654, ASTM C423 and EN 11654. ■ Values [$<100\text{Hz}$ and $> 5\text{K}$] are Non Standard Values.

FEATURES

- STYLE: Square acoustic plates that provide sound absorption for health care, education and open plan offices.
- COMPOSITION: natural wood + coconut fibre.
- THICKNESS: 28mm (+/- 2mm tolerance) / 1.10" (+/- 0.1" tolerance).
- AVAILABLE SIZES: 600mm x 600mm x 28mm / (23.6" x 23.6" x 1.10").
- WEIGHT: 6.3 Kg/m² (13,89 Lbs/ ft²).
- NOISE REDUCTION COEFFICIENT (NRC) - Direct Fix to ceiling: **0.63/m²**;
- suspended 200mm from ceiling: **0.68/m²**.
- FIRE RATING: Class 0 (BS 5422:1990).

③ SMOOTHER® PLATE

ABSORPTION COEFFICIENT

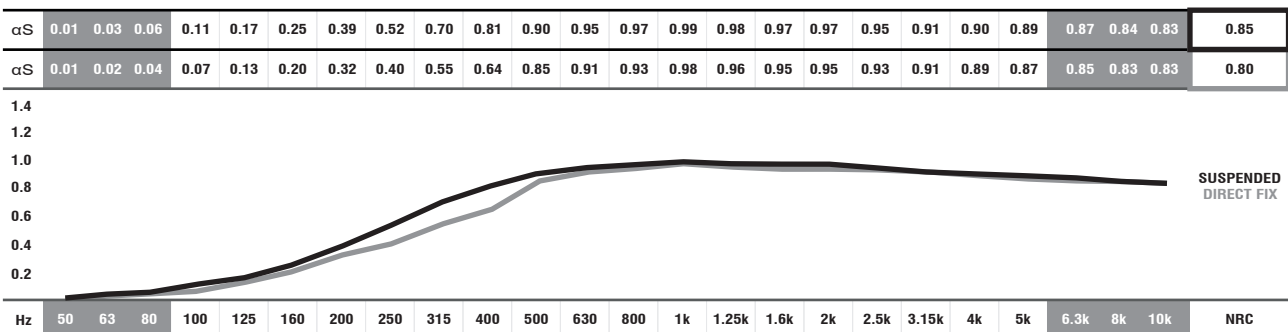

■ ABSORPTION COEFFICIENT: Values in accordance with the standards: EN 20654, ASTM C423 and EN 11654. ■ Values [$<100\text{Hz}$ and $> 5\text{K}$] are Non Standard Values.

FEATURES

- STYLE: Square acoustic plates that provide sound absorption for health care, education and open plan offices.
- COMPOSITION: Polyester fibre (PET) + fabric.
- THICKNESS: 40mm (+/- 2mm tolerance) / 1.57" (+/- 0.1" tolerance).
- AVAILABLE SIZES: 600mm x 600mm x 40mm / (23.6" x 23.6" x 1.57").
- WEIGHT: 4.2 Kg/m² (9,26 Lbs/ ft²).
- NOISE REDUCTION COEFFICIENT (NRC): Direct Fix to ceiling: **0.80/m²**;
- suspended 200mm from ceiling: **0.85/m²**.
- 100% recyclable.
- FIRE RATING: Class 0 (BS 5422:1990).



Image of 130x70cm model Ref.:ISB130 (on the left) and detail image on the right).

DESCRIPTION

ISOBoard® is an Acoustic Isolation plate to build removable acoustic barriers, applicable as a curtain or a sound divider.

This model was developed with the standard fastening fixing method to be used in music shows, stages, and occasional events, where a practical and quick assembly is always a primordial condition. Each plate has a fastening strip with velcro and safety eyelets fastening points for simple application.

ISOBoard is made of a rigid plate of Polyurethane lined with an agglomerate of textile fibers, later covered with acoustic foam and fabric, providing an acoustic barrier of 39db.

This product can be applied as a window curtain or as a separator between different zones.

The sound waves penetrate the open-cell structure, thus reducing the reflected energy and giving this product an excellent noise divider and sound absorption capacity.

TECHNICAL DRAWINGS

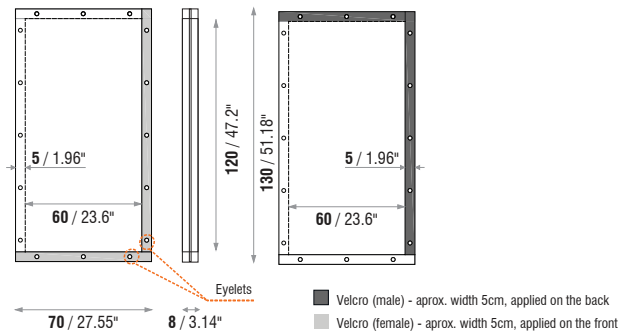

FEATURES

- NRC: 0.70/m²
- Soundproofing: 39db
- Fire-resistance: Germany B1, France M1, GB Class 1, USA V0 / HF1
- Available in two sizes
- Quick assembly; mobile solution for events or to be permanently installed.
- Can be used as a curtain or as a sound divider
- Improves sound's intelligibility and sound insulation between different adjacent performing spaces
- Raw materials: Polyurethane, fabric agglomerate, acoustic foam and fabric.

MODELS AND SIZES

MODELS	HEIGHT	WIDTH	DEPTH	WEIGHT
ISB 130	130 cm (51.18 in)	70 cm (27.55 in)	8 cm (3.14")	0.9 Kg (1.98 lbs)
ISB 120	120 cm (47.2 in)	60 cm (23.6 in)	8 cm (3.14")	0.6 Kg (1.37 lbs)

ABSORPTION COEFFICIENT

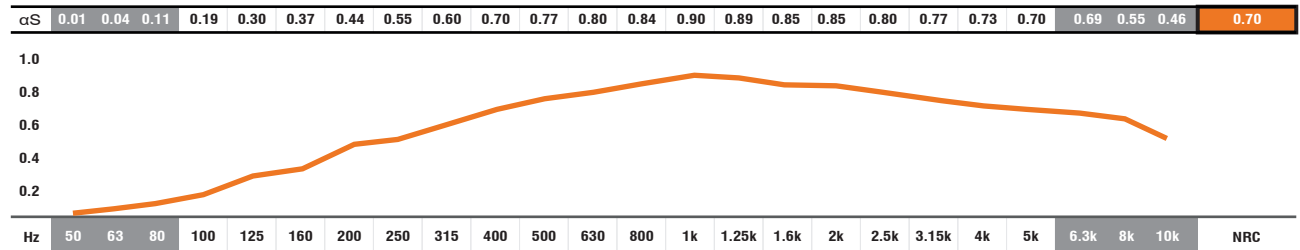

• ABSORPTION COEFFICIENT: Values in accordance with the standards: EN 20654, ASTM C423 and EN 11654. Values [< 100Hz and > 5K] are Non Standard Values.

STANDARD FABRIC COLOURS / (Other customized colours available on demand)



IMPORTANT NOTICES

- JOCAVI® accepts no responsibility for any printing errors. Specifications can be modified without prior notice, if technical or commercial reasons so require.
- The colours shown on this catalogue are only a reference and an illustration of the products finishing. The colours shown are not binding because brightness, contrast and colour balance may vary due to the printing process.
- Colours may vary due to raw-material suppliers' changes and some differences may occur in tonal range.
- Due to its natural origin, wood-based products will always present natural imperfections inherent to the organic nature. And for similar reasons, they will also present traces of old-age in the course of time.
- Wood and Fabric products are highly susceptible to change its appearance with humidity and temperature. Close attention must be paid to the storage conditions and the acclimatization before, during and after the installation.
- Typical Indoor Comfort Standards state a temperature range of 20°C - 27°C (68°F - 81°F), and a relative humidity of less than 60%. These would be considered as normal operational levels of JOCAVI® products' range.
- Despite all the standard sizes of all products, this model can be customised upon previous consultation. Sizes may vary slightly due to their production method and some inherent raw-materials characteristics.



CERAFLECTOR®

DIFFUSION PANEL



PORCELAIN

WOOD



Image of 60x60cm model Ref.:CER060 (on the left) and the same model applied (ambient image).

DESCRIPTION

The acoustic treatment panel CERAFLECTOR® is a 3D controlled dispersion multidirectional reflection panel and its modular design makes it unique in the market. It is built in two different models: in porcelain (CER060) and in wood (CERW060). The angles of reflection of this radial diffusion panel were thoroughly calculated. The depth factor is logarithmically varied and it is, therefore, a three-dimension omnidirectional reflection panel.

The CERAFLECTOR® panel controls primary reflections and fragments them in 64 vertices of incidence using the theoretical numerical sequence ratio of the primitive root as a basis for calculation. Thus, it produces exceptional results of sound diffusion in all directions and provides spaces with considerable sound perception. M1 fire resistant. Available in several colours.

FEATURES

- Two models available: porcelain or Wood.
- Average diffusion: **0.67/m²** [$>100\text{Hz}; <5\text{KHz}$].
- NRC: **0.22/m²** [$>250\text{Hz}; <10\text{KHz}$].
- 100% recyclable.
- Fire-resistance: Euroclass A1 (similar to old M0) for porcelain; B-s1,d0 (similar to old M3) for the wood model.
- Installation: accessories included.
- Manufactured with self-sustainable forest wood.
- Finished with ecological veneers.
- Package: 2 units.

DIFFUSION - ABSORPTION COEFFICIENT

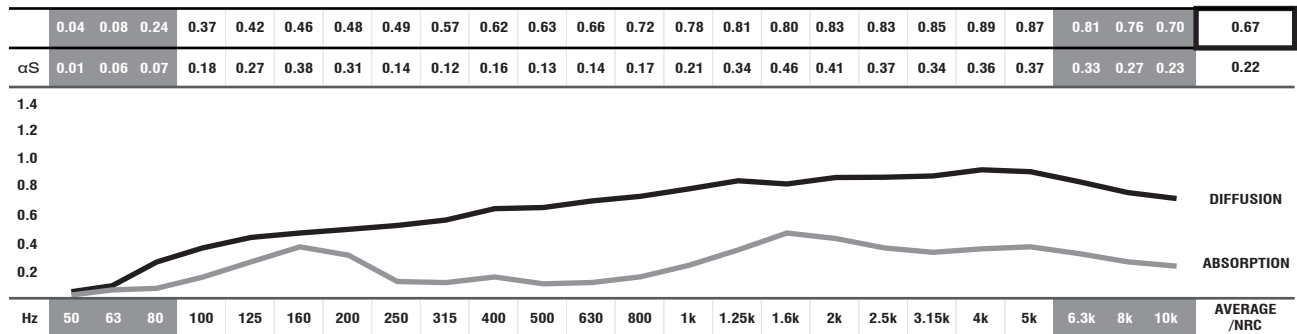

■ ABSORPTION COEFFICIENT: Values in accordance with the standards: EN 20654, ASTM C423 and EN 11654. ■ Values [$<100\text{Hz}$ and $>5\text{K}$] are Non Standard Values.
 ■ DIFFUSION COEFFICIENT: These values were obtained by mathematical calculations and tests carried out in our laboratory.

STANDARD CERAMIC COLOURS

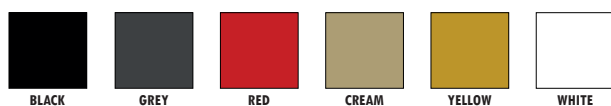

WOOD VENEER FINISHINGS



IMPORTANT NOTICES

- JOCAVI® accepts no responsibility for any printing errors. Specifications can be modified without prior notice, if technical or commercial reasons so require.
- RAL® is an international independent colour standard system partner for industry, trade, architecture and design. Should be consulted before placing any order.
- The colours shown on this catalogue are only a reference and an illustration of the products finishing. The colours shown are not binding because brightness, contrast and colour balance may vary due to the printing process.
- Colours may vary due to raw-material suppliers' changes and some differences may occur in tonal range.
- Sizes may vary slightly due to their production method and some inherent raw-materials characteristics.

TECHNICAL DRAWINGS

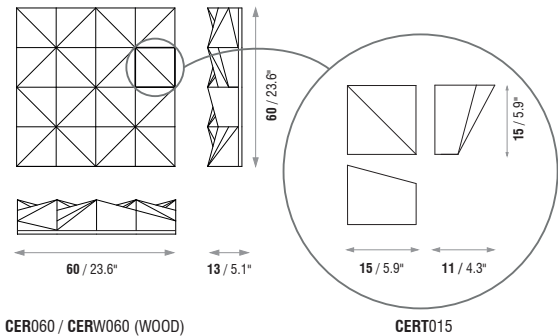

MODELS AND SIZES

MODELS	HEIGHT	WIDTH	DEPTH	WEIGHT
CER060	60 cm (23.6 in)	60 cm (23.6 in)	13 cm (5.1 in)	23.7 Kg (52.25 lbs)
CERW060	60 cm (23.6 in)	60 cm (23.6 in)	13 cm (5.1 in)	22.6 Kg (38.80 lbs)
CERT015	15 cm (5.9 in)	15 cm (5.9 in)	11 cm (4.3 in)	1.4 Kg (3.09 lbs)



COMPACTFUSER®

DIFFUSION PANEL

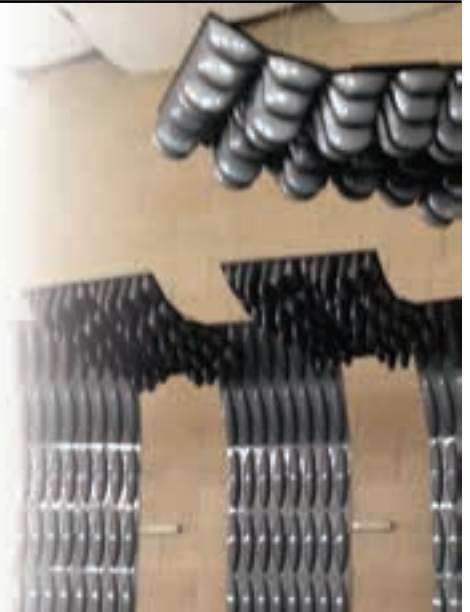
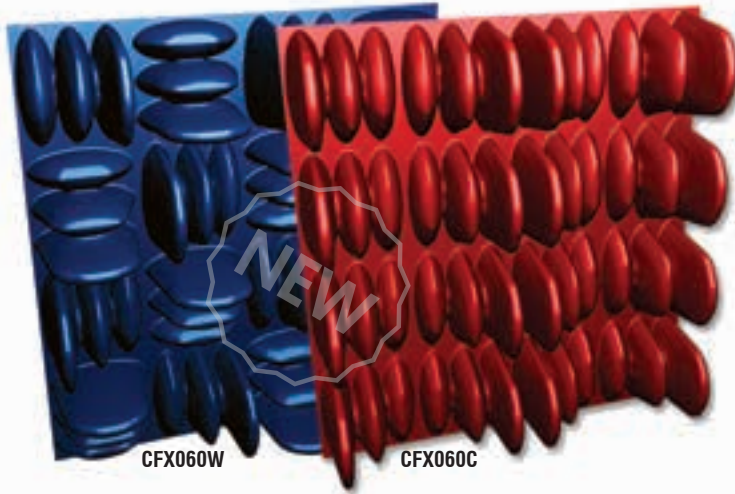

Image of 60x60x15cm models Ref:CFX060W & Ref:CFX060C, (on the top right, EFX180c ambient image).

DESCRIPTION

Diffusion acoustic treatment elements are of imperative use in professional audio rooms, namely in control rooms, where the sound has to be perfect across the entire range of the music spectrum. The installation of these acoustic diffusion components aims to project the instruments' natural sound and maintain some liveliness in the room's acoustics. JOCAVI's COMPACTFUSER has been designed at a small scale of the EFFECTUSER to be used in medium and small rooms dimensions. Its size provides a very homogeneous diffusion pattern in a large band of the sound spectrum, granting an equalized diffusion coefficient on medium/low frequencies, thus making it more balanced when compared with other diffusion shapes and materials. This piece can be coupled and multiplied in order to suit each room's project. Regarding its scattering properties, docking the modules in vertical or horizontal positions, this model allows two options with two different types of diffusion effects; diffusion by scattering in a wide radius or diffusion by compression in a narrower radius. COMPACTFUSER may also be used, like any other JOCAVI® diffusion model, in combination with other models of absorption panels, once correctly properly positioned, giving the room the necessary acoustic conditioning.

FEATURES

- Two diffusion effects; by scattering in a wide radius or by compression in a narrower radius.
- Manufactured with recycled HIPS.
- Average diffusion: $0.61/m^2$ [$>500Hz$; $<5KHz$].
- Fire-resistance: VO - UL94 standards (similar to M2).
- 100% recyclable.
- Installation: accessories included.

SCATTERING FEATURES

To adjust the diffusing properties of these models to the room where this product is applied, the placement of the pieces must be taken into account in order to obtain its best performance, bearing in mind these two types of diffusion:

TECHNICAL DRAWINGS

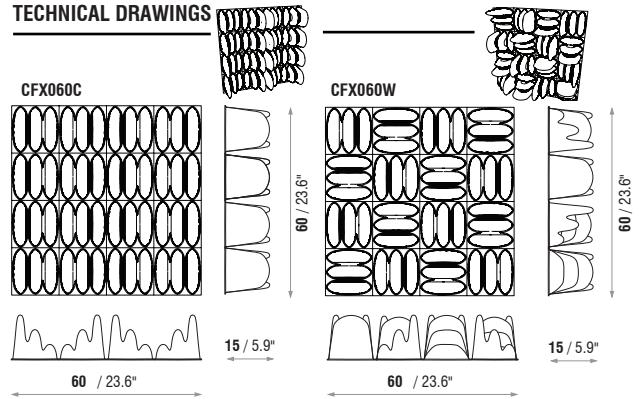

(A) DIFFUSION SCATTERING EFFECT

It emphasizes sound diffusion by scattering in a wider radius and at a shorter distance.

(single unit - example for the CFX060W model)

SIDE VIEW

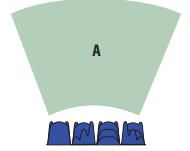

(B) DIFFUSION COMPRESSION EFFECT

It emphasizes sound diffusion by compression in a narrower radius but at a longer distance.

(single unit - example for the CFX060C model)

SIDE VIEW

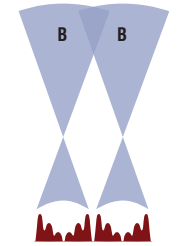

DIFFUSION - ABSORPTION COEFFICIENT

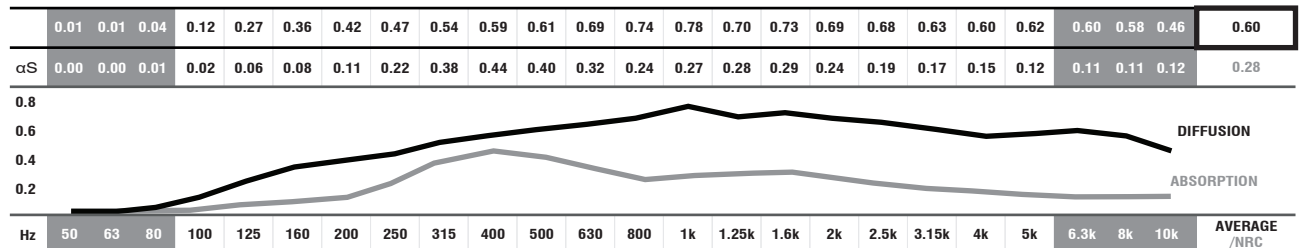

■ ABSORPTION COEFFICIENT: Values in accordance with the standards: EN 20654, ASTM C423 and EN 11654. ■ DIFFUSION COEFFICIENT: These values were obtained by mathematical calculations and tests carried out in our laboratory. ■ Values [$<100Hz$ and $>5K$] are Non Standard Values.

STANDARD HIPS COLOURS



MODELS AND SIZES

MODELS	HEIGHT	WIDTH	DEPTH	WEIGHT
CFX060C	60 cm (23.6 in)	60 cm (23.6 in)	15 cm (11.8 in)	5.4 Kg (11.90 lbs)
CFX060R	60 cm (23.6 in)	60 cm (23.6 in)	15 cm (11.8 in)	5.4 Kg (11.90 lbs)

IMPORTANT NOTICES

- JOCAVI® accepts no responsibility for any printing errors. Specifications can be modified without prior notice, if technical or commercial reasons so require.
- RAL® is an international independent colour standard system partner for industry, trade, architecture and design. Should be consulted before placing any order.
- The colours shown on this catalogue are only a reference and an illustration of the products finishing. The colours shown are not binding because brightness, contrast and colour balance may vary due to the printing process.
- Colours may vary due to raw-material suppliers' changes and some differences may occur in total range.
- Typical Indoor Comfort Standards state a temperature range of 20°C - 27°C (68°F - 81°F), and a relative humidity of less than 60%. These would be considered as normal operational levels of JOCAVI® products' range.
- Sizes may vary slightly due to their production method and some inherent raw-materials characteristics.



Image of 60x60cm model Ref.:CCK060 (on the left) and (ambient image).

DESCRIPTION

CORKOAK® is a wooden diffusion panel resulting from a combination process of oak wood with cork, which is one of the options concerning JOCAVI™'s 2D diffusion panels.

The use of 2D diffuser panels is one of the classic standers in the construction of music rooms, being extremely efficient to control primary reflections and floating echoes, thus improving the balanced sound atmosphere in the room.

Due to the absorption properties of the cork applied to the low reliefs of this piece, it makes the diffusion curve and the absorption curve closer to each other, thus revealing some interesting absorption coefficients.

This panel is made of solid oakwood and cork with a finish of five different colors of natural varnish. The wood and cork's natural appearance stands out inside the rooms, providing this product a very attractive look, both acoustically and aesthetically.

FEATURES

- Manufactured with self-sustainable Oak wood and Cork
- Average diffusion: 0.59/m² [>500Hz; <5KHz]
- NRC: 0.30/m² [>250Hz; <10KHz]
- Finished with ecological varnishes
- 100% recyclable
- Installation: wall and ceilings accessories included
- Fire-resistance: B-s1, d0 (similar to old M3)
- 100% recyclable
- Package: 2 units

TECHNICAL DRAWINGS

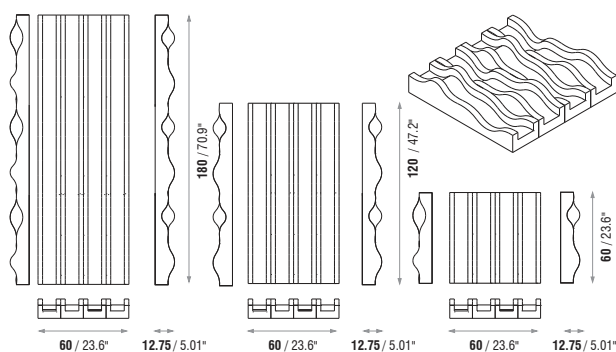

MODELS AND SIZES

MODELS	HEIGHT	WIDTH	DEPTH	WEIGHT
CCK 180	180 cm (70.9 in)	60 cm (23.6 in)	12.75cm (5.01 in)	42 Kg (99.18 lbs)
CCK 120	120 cm (47.2 in)	60 cm (23.6 in)	12.75cm (5.01 in)	28 Kg (66.12 lbs)
CCK 060	60 cm (23.6 in)	60 cm (23.6 in)	12.75cm (5.01 in)	14 Kg (33.06 lbs)

STANDARD CORK COLOUR



CORK

ABSORPTION COEFFICIENT

αS	0.00	0.03	0.04	0.05	0.06	0.11	0.14	0.15	0.22	0.27	0.33	0.38	0.40	0.44	0.39	0.33	0.29	0.22	0.19	0.15	0.13	0.10	0.06	0.50	0.30
Avg	0.04	0.10	0.22	0.37	0.44	0.49	0.52	0.54	0.56	0.60	0.59	0.64	0.69	0.74	0.72	0.70	0.70	0.66	0.61	0.57	0.40	0.32	0.25	0.19	0.59

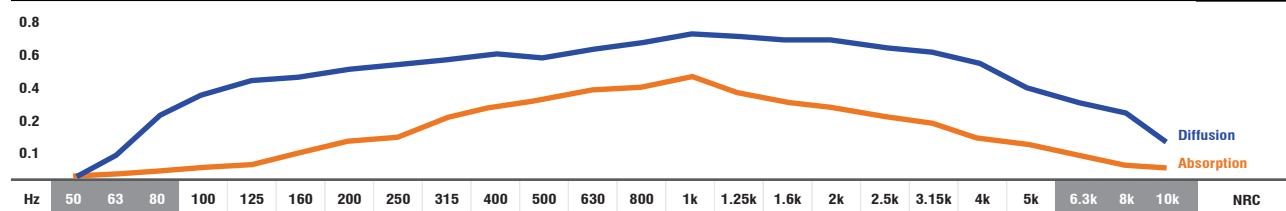

● ABSORPTION COEFFICIENT: Values in accordance with the standards: EN 20654, ASTM C423 and EN 11654.

■ Values [<100Hz and > 5K] are Non Standard Values.

ENGINEERED COLOURED WOOD COLOURS

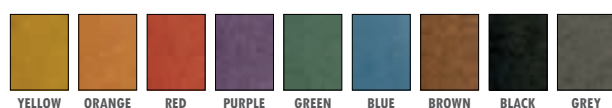

WOOD VENEER FINISHINGS



IMPORTANT NOTICES

- JOCAVI® accepts no responsibility for any printing errors. Specifications can be modified without prior notice, if technical or commercial reasons so require.
- The colours shown on this catalogue are only a reference and an illustration of the products finishing. The colours shown are not binding because brightness, contrast and colour balance may vary due to the printing process.
- Colours may vary due to raw-material suppliers' changes and some differences may occur in tonal range.
- Due to its natural origin, wood-based products will always present natural imperfections inherent to the organic nature. And for similar reasons, they will also present traces of old-age in the course of time.
- Wood and Fabric products are highly susceptible to change its appearance with humidity and temperature. Close attention must be paid to the storage conditions and the acclimatization before, during and after the installation.
- Typical Indoor Comfort Standards state a temperature range of 20°C - 27°C (68°F - 81°F), and a relative humidity of less than 60%. These would be considered as normal operational levels of JOCAVI® products' range.
- Despite all the standard sizes of all products, this model can be customised upon previous consultation. Sizes may vary slightly due to their production method and some inherent raw-materials characteristics.



DYNAMICFLOW®

DIFFUSION PANEL

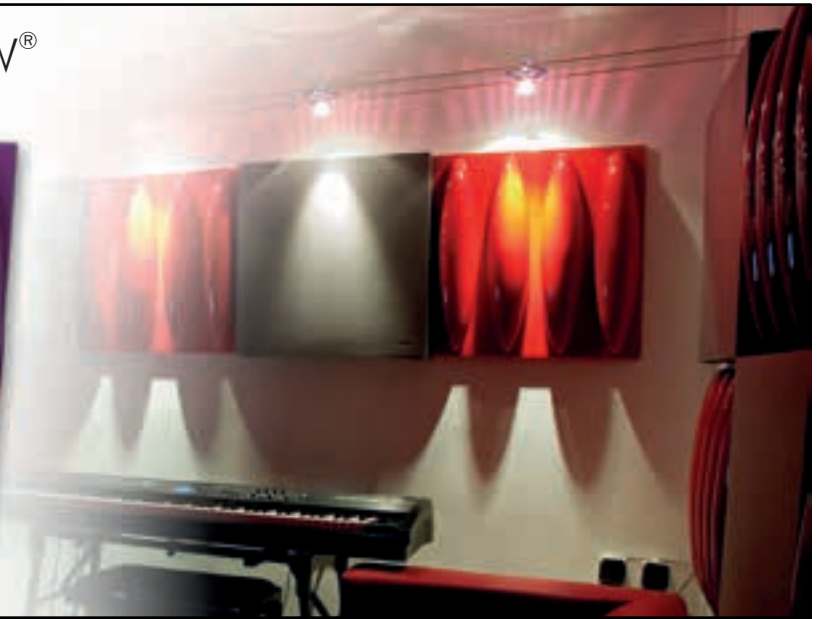

Image of 60x60cm model Ref.:DYN060.

DESCRIPTION

JOCAVI® has developed this acoustic diffusion panel by using non-linear convex shapes, based on a set of three ellipses which were later altered and optimised in order to achieve an oval shape with better angular diffusion coverage.

The external raw material of this panel was selected out of some materials that have the fastest and most specific properties required for a diffuser with these characteristics. However, the HIPS still has some advantages, namely UV protection, impact resistance and fire resistance similar to old M2.

The DYNAMICFLOW®'s interior is composed of a substance made of impregnated mineral fibres and textiles, which gives this product a specific mass and also contributes to its consistence. The back part consists of an even surface. Its shape adjusts to even surfaces. It can be used on "T" profile false ceilings or on walls, by using our glues or fastening materials.

TECHNICAL DRAWINGS

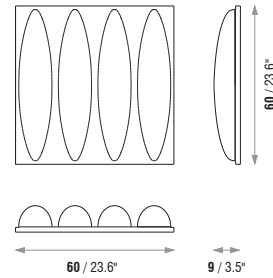

FEATURES

- Manufactured with HIPS.
- Average diffusion: **0.61/m²** [$>100\text{Hz}; <5\text{KHz}$].
- NRC: **0.20/m²** [$>250\text{Hz}; <10\text{KHz}$].
- Fire-resistance: VO - UL94 standards (similar to M2).
- 100% recyclable.
- Installation: accessories included.

MODELS AND SIZES

MODELS	HEIGHT	WIDTH	DEPTH	WEIGHT
DYN060	60 cm (23.6 in)	60 cm (23.6 in)	9 cm (3.5 in)	4.3 Kg (9.48 lbs)

DIFFUSION - ABSORPTION COEFFICIENT

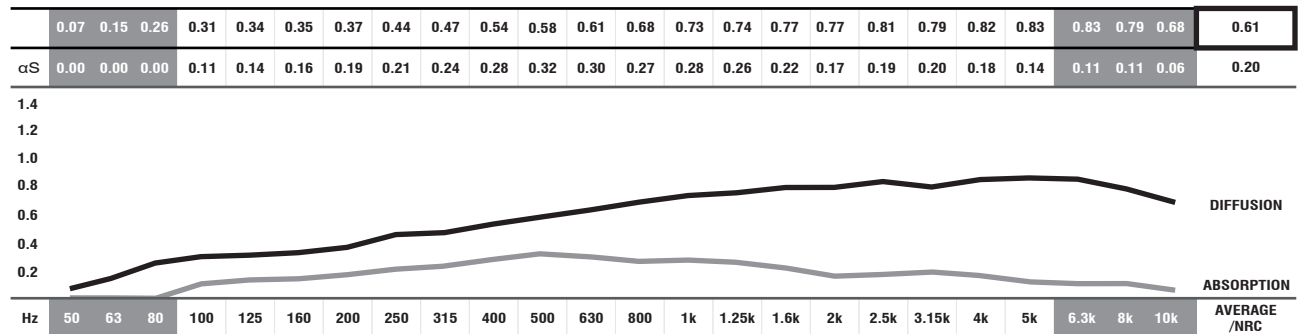

■ ABSORPTION COEFFICIENT: Values in accordance with the standards: EN 20654, ASTM C423 and EN 11654. ■ Values [$<100\text{Hz}$ and $>5\text{K}$] are Non Standard Values.
 ■ DIFFUSION COEFFICIENT: These values were obtained by mathematical calculations and tests carried out in our laboratory.

STANDARD HIPS COLOURS

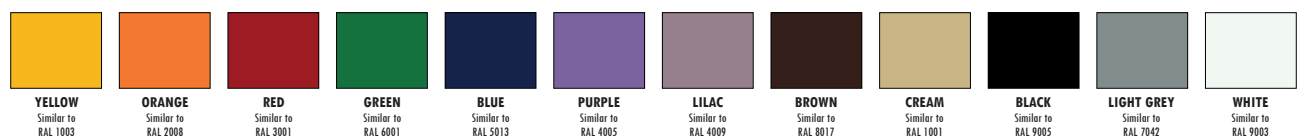

IMPORTANT NOTICES

- JOCAVI® accepts no responsibility for any printing errors. Specifications can be modified without prior notice, if technical or commercial reasons so require.
- RAL® is an international independent colour standard system partner for industry, trade, architecture and design. Should be consulted before placing any order.
- The colours shown on this catalogue are only a reference and an illustration of the products finishing. The colours shown are not binding because brightness, contrast and colour balance may vary due to the printing process.
- Colours may vary due to raw-material suppliers' changes and some differences may occur in total range.
- Typical Indoor Comfort Standards state a temperature range of 20°C - 27°C (68°F - 81°F), and a relative humidity of less than 60%. These would be considered as normal operational levels of JOCAVI® products' range.
- Sizes may vary slightly due to their production method and some inherent raw-materials characteristics.



DIAMOND®
DIFFUSION PANEL



Image of 60x60cm model Ref.:DIA060.

DESCRIPTION

The DIAMOND® is a 3D-controlled dispersion multidirectional reflection panel with a depth factor that is logarithmically varied. It is, therefore, a three-dimension omnidirectional reflection panel that controls primary reflections and fragments the energy in 64 vertices of incidence by using the theoretical numerical sequence ratio of the primitive root as a basis for calculation. It is built with HIPS recyclable material, and its modular design makes it a particular and high-performance diffuser. The reflection angles were optimised according to mid-size room applications.

The DIAMOND® is an acoustic diffusion element with a lozenge geometry. The front view refers to 64 interconnected polygons with four multiple sound diffusion angles, which determines a diamond shape. It was created in 16 singular modules that have a quadrangular base and different extrusion heights on each corner. The combination of those positions results in a geometrically scattering diffusion pattern with a very attractive shape.

Thus, the DIAMOND® produces exceptional results of sound diffusion effect and provides spaces with considerable sound perception.

TECHNICAL DRAWINGS

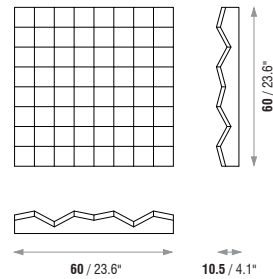

FEATURES

- Manufactured with HIPS.
- Average diffusion: **0.63/m²** [$>100\text{Hz}$; $<5\text{KHz}$].
- NRC: **0.22/m²** [$>250\text{Hz}$; $<10\text{KHz}$].
- Fire-resistance: VO - UL94 standards (similar to M2).
- 100% recyclable.
- Installation: accessories included.

MODELS AND SIZES

MODELS	HEIGHT	WIDTH	DEPTH	WEIGHT
DIA060	60 cm (23.6 in)	60 cm (23.6 in)	10.5 cm (4.1 in)	4.5 Kg (9.92 lbs)

DIFFUSION - ABSORPTION COEFFICIENT

	0.04	0.08	0.24	0.35	0.44	0.46	0.50	0.55	0.58	0.59	0.58	0.66	0.72	0.71	0.69	0.70	0.73	0.79	0.80	0.75	0.76	0.73	0.75	0.71	0.63
α_S	0.01	0.03	0.06	0.10	0.15	0.14	0.20	0.25	0.23	0.38	0.29	0.25	0.27	0.22	0.25	0.19	0.13	0.13	0.14	0.10	0.09	0.06	0.05	0.05	0.22
Hz	50	63	80	100	125	160	200	250	315	400	500	630	800	1k	1.25k	1.6k	2k	2.5k	3.15k	4k	5k	6.3k	8k	10k	AVERAGE /NRC

■ ABSORPTION COEFFICIENT: Values in accordance with the standards: EN 20654, ASTM C423 and EN 11654. ■ Values [$<100\text{Hz}$ and $>5\text{K}$] are Non Standard Values.
 ■ DIFFUSION COEFFICIENT: These values were obtained by mathematical calculations and tests carried out in our laboratory.

STANDARD HIPS COLOURS

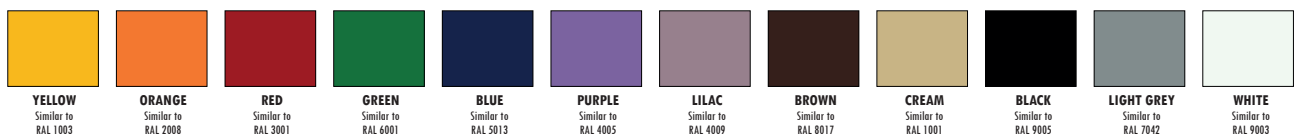

IMPORTANT NOTICES

- JOCAVI® accepts no responsibility for any printing errors. Specifications can be modified without prior notice, if technical or commercial reasons so require.
- RAL® is an international independent colour standard system partner for industry, trade, architecture and design. Should be consulted before placing any order.
- The colours shown on this catalogue are only a reference and an illustration of the products finishing. The colours shown are not binding because brightness, contrast and colour balance may vary due to the printing process.
- Colours may vary due to raw-material suppliers' changes and some differences may occur in tonal range.
- Typical Indoor Comfort Standards state a temperature range of 20°C - 27°C (68°F - 81°F), and a relative humidity of less than 60%. These would be considered as normal operational levels of JOCAVI® products' range.
- Sizes may vary slightly due to their production method and some inherent raw-materials characteristics.

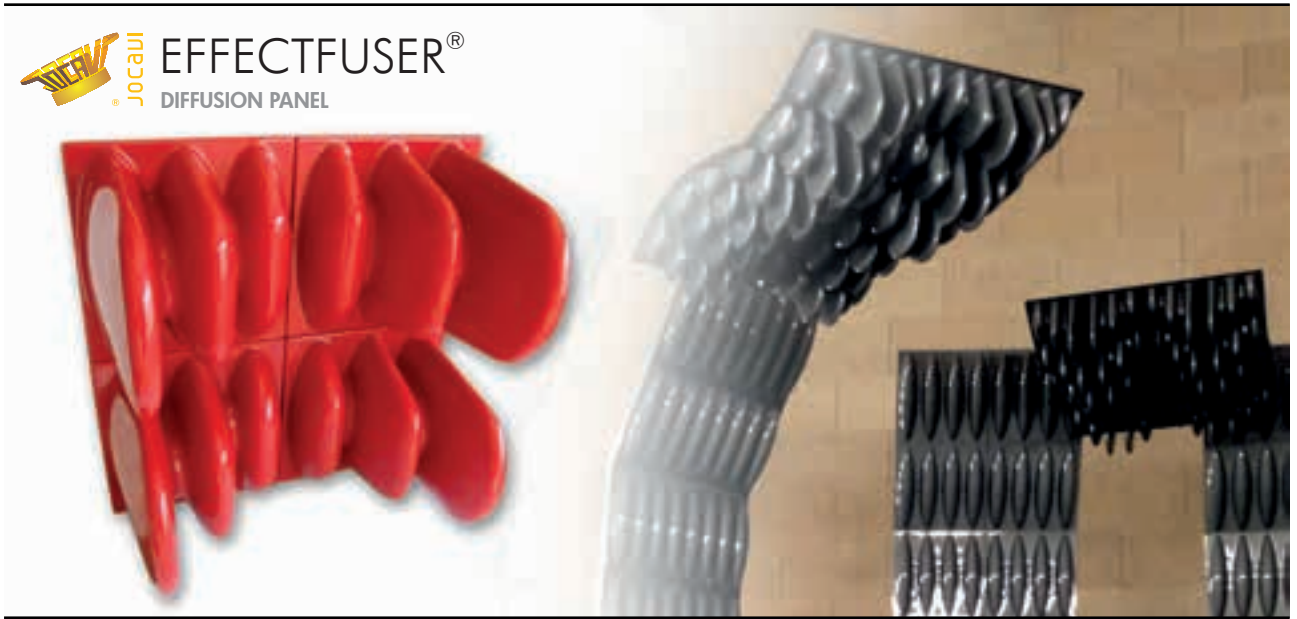

Image of 60x60cm model Ref.:EFX060 (on the left) and 180x120cm Ref.:EFXCOMBI (ambient image).

DESCRIPTION

Diffusion shells are acoustic treatment elements used in large volume rooms, such as theatres and auditoriums, where orchestral concerts or mere recitals take place. The installation of these acoustic diffusion components aims to project the natural sound from the instruments and maintain some liveliness in the room's acoustics. JOCAVI®'s EFFECTFUSER® has been designed at the scale of these needs. It is a large-sized diffuser that provides a very homogeneous diffusion within the diffuse sound spectrum. Due to its shape and depth, the EFFECTFUSER® has a high diffusion coefficient on medium/low frequencies, thus making it more balanced when compared with other diffusers. This piece can be coupled and multiplied in order to suit each room's project. When mounted, several modules must be grouped in order to obtain a diffusion area that is proportional to each space. They are properly positioned on ceilings or walls in order to obtain sound diffusion at the intended angles. EFFECTFUSER® may also be used, like any other JOCAVI® diffusion model, in combination with other models of absorption panels.

FEATURES

- Manufactured with recycled HIPS.
- Average diffusion: **0.61/m²** [$>100\text{Hz}$; $<5\text{KHz}$].
- NRC: **0.20/m²** [$>250\text{Hz}$; $<10\text{KHz}$].
- Fire-resistance: VO - UL94 standards (similar to M2).
- 100% recyclable.
- Installation: accessories included.

TECHNICAL DRAWINGS

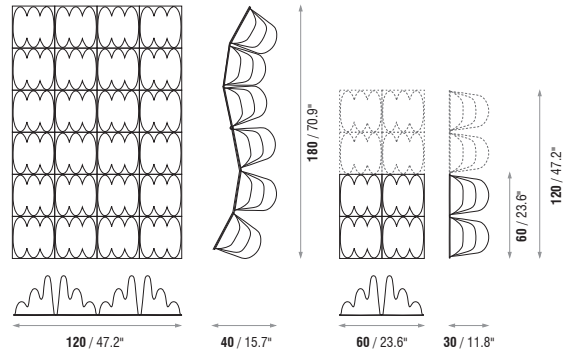

MODELS AND SIZES

MODELS	HEIGHT	WIDTH	DEPTH	WEIGHT
EFXcombi	180 cm (70.9 in)	120 cm (47.2 in)	40 cm (15.7 in)	55.5 Kg (122.36 lbs)
EFX120	120 cm (47.2 in)	60 cm (23.6 in)	30 cm (11.8 in)	10.8 Kg (23.81 lbs)
EFX060	60 cm (23.6 in)	60 cm (23.6 in)	30 cm (11.8 in)	5.4 Kg (11.90 lbs)

DIFFUSION - ABSORPTION COEFFICIENT

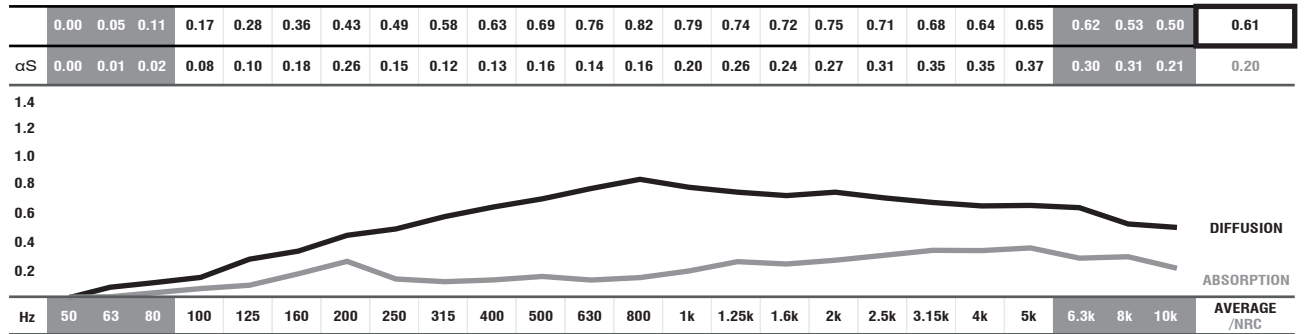

STANDARD HIPS COLOURS

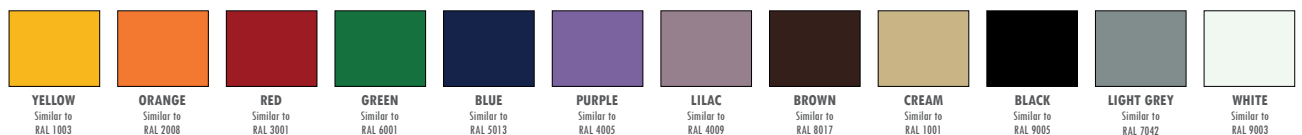

IMPORTANT NOTICES

- JOCAVI® accepts no responsibility for any printing errors. Specifications can be modified without prior notice, if technical or commercial reasons so require.
- RAL® is an international independent colour standard system partner for industry, trade, architecture and design. Should be consulted before placing any order.
- The colours shown on this catalogue are only a reference and an illustration of the products finishing. The colours shown are not binding because brightness, contrast and colour balance may vary due to the printing process.
- Colours may vary due to raw-material suppliers' changes and some differences may occur in tonal range.
- Typical Indoor Comfort Standards state a temperature range of 20°C - 27°C (68°F - 81°F), and a relative humidity of less than 60%. These would be considered as normal operational levels of JOCAVI® products' range.
- Sizes may vary slightly due to their production method and some inherent raw-materials characteristics.



MELLOWCLOUD[®] DIF

SUSPENDED DIFFUSION PANEL

THREE
UPDATED
SHAPES



Image of Mellowcloud[®] DIF model Ref.:MELDIF applied (ambient image).

DESCRIPTION

The MELLOWCLOUD[®] DIF is a One Dimensional Curved shape Diffuser Acoustic panel for Multipurpose, Auditoriums and Theatre Halls.

This is a product was devised to be suspended in ceilings or metal grids; it can be also used as fixed or motorized acoustic shells. This type of acoustic material is mainly applied in large area of application such as auditoriums, conference rooms, multipurpose rooms and airports, places where acoustic treatment with a modular continuous surface is required.

It is a diffuser material that also provides somewhat of homogenous sound spectrum absorption. The MELLOWCLOUD[®] DIF evolves and meets the aesthetic challenge, while also offering an optimal sound diffusion and absorption characteristics.

The architecture involves rectilinear and curvilinear lines. Flat rigid surfaces provide uneven sound pressure across the audience area. Shaping and curving the surfaces can improve the coverage of the sound diffusion; this will help the results, although it is a vast subject that requires its own tools of experimentation on case-by-case base for each project. MELLOWCLOUD[®] DIF provides architects and designers with wide latitude in curvilinear design.

MELLOWCLOUD[®] DIF can be customized as to its shape and size to better adapt to each space. Custom panels offer in a variety of types, sizes, ellipses, geometric shapes, vaults, acoustical domes, thicknesses, and finishes.

FEATURES

- Micro-fibers, reinforced gypsum and finishing.
- Average diffusion: **0.37/m²** [$>100\text{Hz}$; $<5\text{KHz}$].
- NRC: **0.18/m²** [$>250\text{Hz}$; $<10\text{KHz}$].
- Fire-resistance: Euroclass A2-s1,d0 (similar to old M0).
- Standard and custom shapes.
- Optimized shape, arraying and positioning insures uniform coverage.
- Suspended using Integrated mounting hardware and cable system (only four supports/hangers by each panel).
- Very lightweight (4 Kg/m² - 80 mm thick panel)

TECHNICAL DRAWINGS

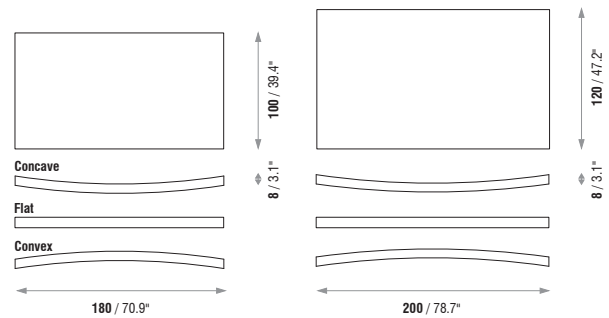

MODELS AND SIZES

MODELS	HEIGHT	WIDTH	DEPTH	WEIGHT
MCDDIF200	200 cm (78.7 in)	120 cm (47.2 in)	8 cm (3.1 in)	14 Kg (30.86 lbs)
MCDDIF180	180 cm (70.9 in)	100 cm (39.4 in)	8 cm (3.1 in)	9 Kg (19.84 lbs)

DIFFUSION - ABSORPTION COEFFICIENT

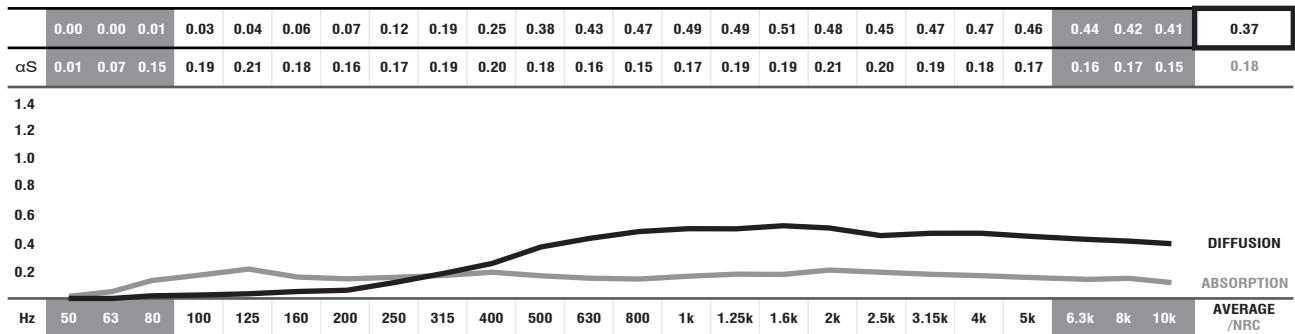

■ DIFFUSION COEFFICIENT: These values were obtained by mathematical calculations and tests carried out in our laboratory.

■ Values [$<100\text{Hz}$ and $> 5\text{K}$] are Non Standard Values.

■ ABSORPTION COEFFICIENT: Values in accordance with the standards: EN 20654, ASTM C423 and EN 11654.

STANDARD PROJECTABLE CELLULOSE FINISHING COLOURS

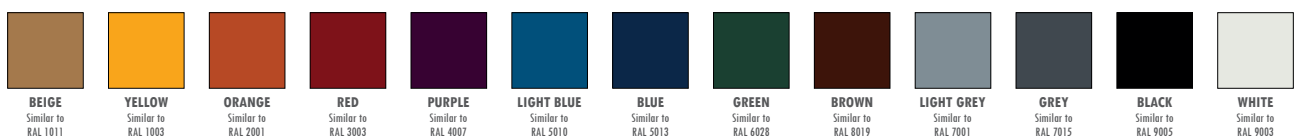

IMPORTANT NOTICES

- JOCAVI[®] accepts no responsibility for any printing errors. Specifications can be modified without prior notice, if technical or commercial reasons so require.
- RAL[®] is an international independent colour standard system partner for industry, trade, architecture and design. Should be consulted before placing any order.
- The colours shown on this catalogue are only a reference and an illustration of the products finishing. The colours shown are not binding because brightness, contrast and colour balance may vary due to the printing process.
- Colours may vary due to raw-material suppliers' changes and some differences may occur in tonal range.
- Wood and Fabric products are highly susceptible to change its appearance with humidity and temperature. Close attention must be paid to the storage conditions and the acclimatization before, during and after the installation.
- Typical Indoor Comfort Standards state a temperature range of 20°C - 27°C (68°F - 81°F), and a relative humidity of less than 60%. These would be considered as normal operational levels of JOCAVI[®] products' range.
- Despite all the standard sizes of all products, this model can be customised upon previous consultation. Sizes may slightly vary due to their production method and some inherent raw-materials characteristics.



Image of 60x60cm model Ref.:N3Q060.

DESCRIPTION

From many years, the quadratic diffusers became a classic shape in architectural acoustics. JOCAVI[®] revisited and made a new design of the oldest project of acoustic diffuser modules.

Starting from the same principle of the calculations for Quadratic diffusers, we reviewed it with a new approach and add a new energy flow calculation theory that adds better scattering predicates and advantages. NEO 3Q[®] has a three grade design pattern, making the distribution of energy evenly and balanced within its effective frequency range.

The NEO 3Q[®] is designed to provide a more uniform diffusion of the sound reflections radiated against it, mostly in the mid and high frequencies sound field.

In cases where the reflections are disturbing the sound image and it is not advisory to add further absorption, diffusers are a very useful solution to reduce flutter echoes, early reflections, comb filtering etc.

This model is made of HIPS, with a composite filling of recycled materials, which gives this product a specific mass and also contributes to its consistence.

It is available in several different colours by using our fastening materials it can be applied on walls and ceilings, as well as "T" type dropped ceilings.

TECHNICAL DRAWINGS

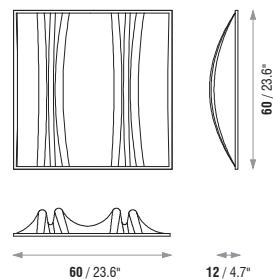

FEATURES

- Manufactured with HIPS.
- Average diffusion: **0.67/m²** [$>100\text{Hz}; <5\text{KHz}$].
- NRC: **0.10/m²** [$>250\text{Hz}; <10\text{KHz}$].
- Fire-resistance: VO - UL94 standards (similar to M2).
- 100% recyclable.
- Installation: accessories included.
- T-Ceiling application.
- Two different shapes (**NEO6Q** and **NEO3Q**).

MODELS AND SIZES

MODELS	HEIGHT	WIDTH	DEPTH	WEIGHT
N3Q060	60 cm (23.6 in)	60 cm (23.6 in)	12 cm (4.7 in)	4.3 Kg (9.48 lbs)

DIFFUSION - ABSORPTION COEFFICIENT

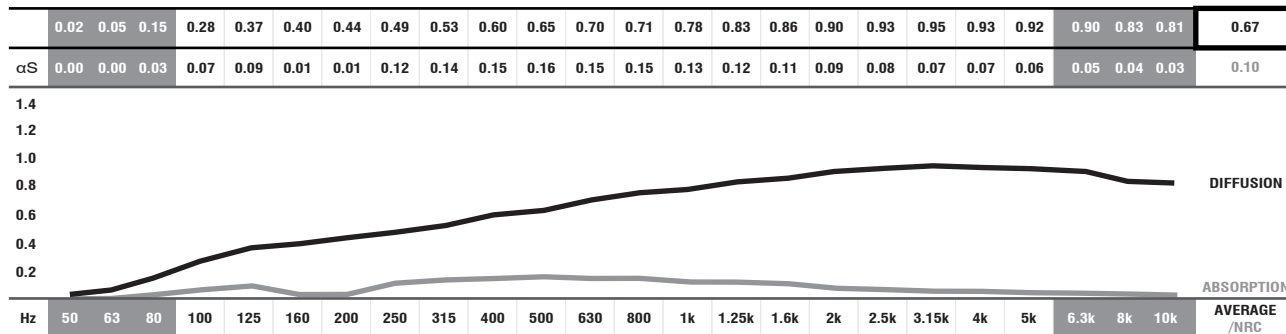

■ ABSORPTION COEFFICIENT: Values in accordance with the standards: EN 20654, ASTM C423 and EN 11654.

■ Values [$<100\text{Hz}$ and $>5\text{K}$] are Non Standard Values.

■ DIFFUSION COEFFICIENT: These values were obtained by mathematical calculations and tests carried out in our laboratory.

Presented values above are based on tests and measurements done with the NEO 6Q model.

STANDARD HIPS COLOURS

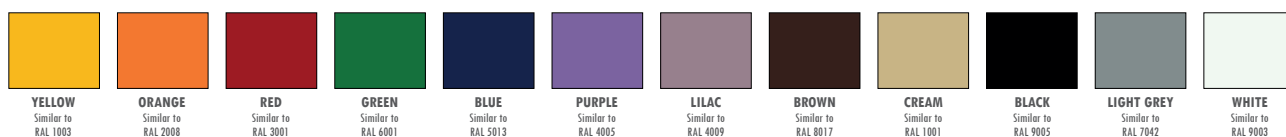

IMPORTANT NOTICES

- JOCAVI[®] accepts no responsibility for any printing errors. Specifications can be modified without prior notice, if technical or commercial reasons so require.
- RAL[®] is an international independent colour standard system partner for industry, trade, architecture and design. Should be consulted before placing any order.
- The colours shown on this catalogue are only a reference and an illustration of the products finishing. The colours shown are not binding because brightness, contrast and colour balance may vary due to the printing process.
- Colours may vary due to raw-material suppliers' changes and some differences may occur in tonal range.
- Typical Indoor Comfort Standards state a temperature range of 20°C - 27°C (68°F - 81°F), and a relative humidity of less than 60%. These would be considered as normal operational levels of JOCAVI[®] products' range.
- Sizes may vary slightly due to their production method and some inherent raw-materials characteristics.



NEO 6Q[®]

DIFFUSION PANEL

NEW



Image of 60x60cm model Ref. N6Q060.

DESCRIPTION

From many years the Quadratic diffusers became a classic shape in architectural acoustics. JOCAVI[®] revisited and made a new design of the oldest project of acoustic diffuser modules.

Starting from the same principle of the calculations for Quadratic diffusers, we reviewed it with a new approach and add a new energy flow calculation theory that adds better scattering predicates and advantages. The phase grating surface of the NEO6Q[®] is designed to provide a more uniform diffusion of the sound reflections radiated against it, mostly in the mid and high frequencies sound field. NEO6Q[®] has a nine stripe design pattern, making the distribution of energy homogeneous and balanced within its effective frequency range. In the cases where the reflections are disturbing the sound image and it is not advisory to add further absorption, diffusers are a very useful solution to reduce flutter echoes, early reflections, comb filtering etc., these components must be placed on the disturbing surface so that these derogatory characteristics can be manipulated.

This model is made of HIPS, with a composite filling of recycled materials, which gives this product a specific mass and also contributes to its consistence.

It is available in several different colours by using our fastening materials it can be applied on walls and ceilings, as well as "T" type dropped ceilings.

FEATURES

- Manufactured with HIPS.
- Average diffusion: **0.67/m²** [$>100\text{Hz}; <5\text{KHz}$].
- NRC: **0.10/m²** [$>250\text{Hz}; <10\text{KHz}$].
- Fire-resistance: VO - UL94 standards (similar to M2).
- 100% recyclable.
- Installation: accessories included.
- T-Ceiling application.
- Two different shapes (NEO6Q and NEO3Q).

TECHNICAL DRAWINGS

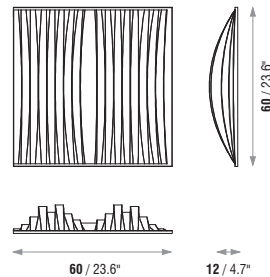

MODELS AND SIZES

MODELS	HEIGHT	WIDTH	DEPTH	WEIGHT
N3Q060	60 cm (23.6 in)	60 cm (23.6 in)	12 cm (4.7 in)	4.3 Kg (9.48 lbs)

DIFFUSION - ABSORPTION COEFFICIENT

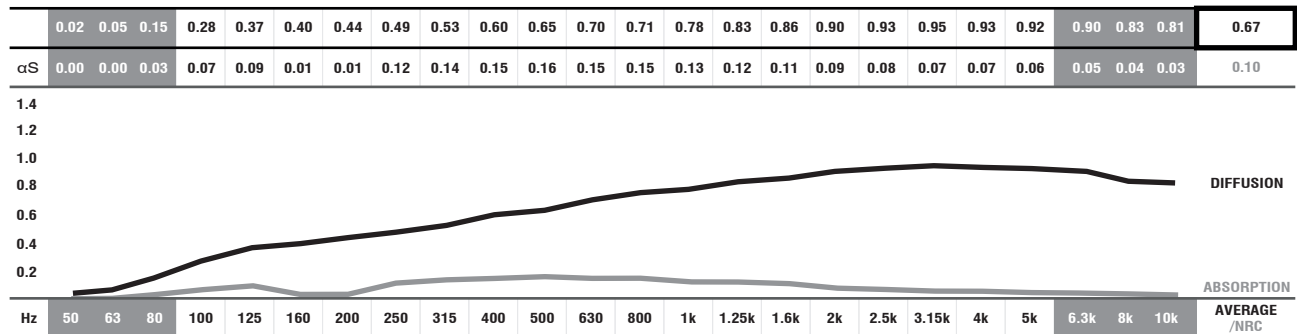

■ ABSORPTION COEFFICIENT: Values in accordance with the standards: EN 20654, ASTM C423 and EN 11654.

■ Values [$<100\text{Hz}$ and $> 5\text{K}$] are Non Standard Values.

■ DIFFUSION COEFFICIENT: These values were obtained by mathematical calculations and tests carried out in our laboratory.

STANDARD HIPS COLOURS

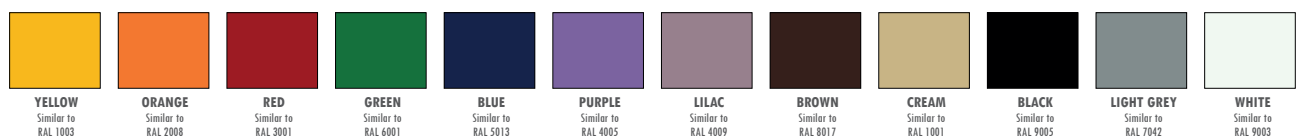

IMPORTANT NOTICES

- JOCAVI[®] accepts no responsibility for any printing errors. Specifications can be modified without prior notice, if technical or commercial reasons so require.
- RAL[®] is an international independent colour standard system partner for industry, trade, architecture and design. Should be consulted before placing any order.
- The colours shown on this catalogue are only a reference and an illustration of the products finishing. The colours shown are not binding because brightness, contrast and colour balance may vary due to the printing process.
- Colours may vary due to raw-material suppliers' changes and some differences may occur in tonal range.
- Wood and Fabric products are highly susceptible to change its appearance with humidity and temperature. Close attention must be paid to the storage conditions and the acclimatization before, during and after the installation.
- Typical Indoor Comfort Standards state a temperature range of 20°C - 27°C (68°F - 81°F), and a relative humidity of less than 60%. These would be considered as normal operational levels of JOCAVI[®] products' range.
- Despite all the standard sizes of all products, this model can be customised upon previous consultation. Sizes may slightly vary due to their production method and some inherent raw-materials characteristics.



Image of 60x60cm model Ref.:PLR060.

DESCRIPTION

Plura® is an acoustic diffusion panel, manufactured in HIPS on an absorbent filling box.

His design has a geometry that reproduces symmetry at a 180 rotation. It consists of a combination of two ellipses in one bent hollow, thus giving it a predominantly round shape with tenuous angles, which is good for diffusion.

Plura® is meant to diffuse mid and mid-high frequencies. When using multiple pieces jointly on a continuous area, it improves its sound diffusion efficiency. Amazing diffusion effect can be obtained when used in large rooms. We can make several different aesthetic combination effects by rotating the panels 90° or 180° and positioning them according to one's taste and to the room's requirements.

The inner part of this model is made on a composite substance of impregnated mineral fibers and textiles, which gives this product a specific mass and also contributes to its consistence.

The external raw material of this panel was selected out of some materials that have the fastest and most specific properties required for a diffuser with these characteristics, however the HIPS still has some advantages, namely UV protection, impact resistance and fire resistance similar to old M2.

The back part consists of a flat surface, which includes the mounting accessories.

TECHNICAL DRAWINGS

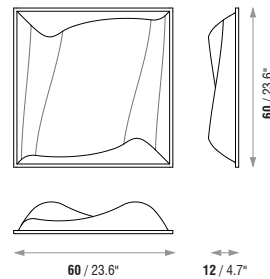

FEATURES

- Manufactured with HIPS.
- Average diffusion: **0.67/m²** [$>100\text{Hz}$; $<5\text{KHz}$].
- NRC: **0.33/m²** [$>250\text{Hz}$; $<10\text{KHz}$].
- Fire-resistance: VO - UL94 standards (similar to M2).
- 100% recyclable.
- Installation: accessories included.
- T-Ceiling application.

MODELS AND SIZES

MODELS	HEIGHT	WIDTH	DEPTH	WEIGHT
PLR060	60 cm (23.6 in)	60 cm (23.6 in)	12 cm (4.7 in)	4.3 Kg (9.48 lbs)

DIFFUSION - ABSORPTION COEFFICIENT

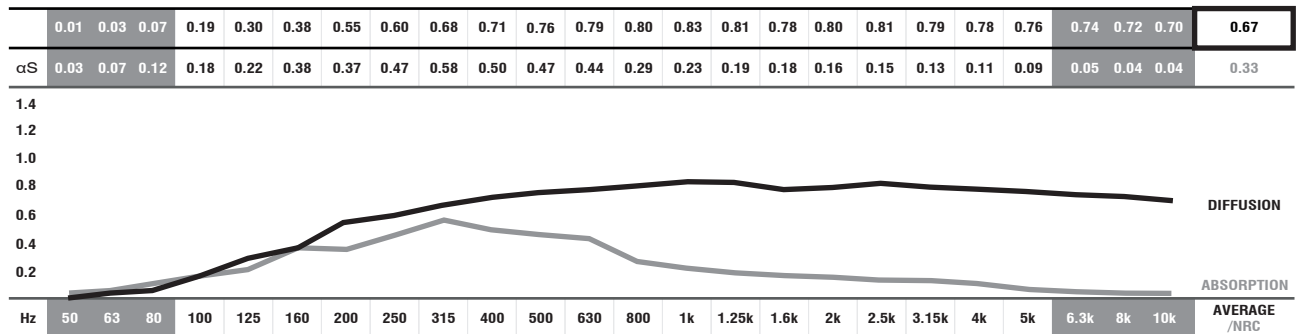

■ ABSORPTION COEFFICIENT: Values in accordance with the standards: EN 20654, ASTM C423 and EN 11654.

■ Values [$<100\text{Hz}$ and $>5\text{K}$] are Non Standard Values.

■ DIFFUSION COEFFICIENT: These values were obtained by mathematical calculations and tests carried out in our laboratory.

STANDARD HIPS COLOURS

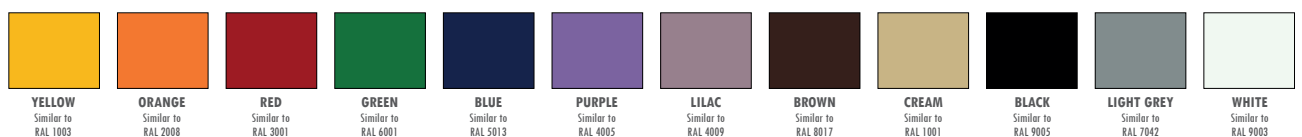

IMPORTANT NOTICES

- JOCAVI® accepts no responsibility for any printing errors. Specifications can be modified without prior notice, if technical or commercial reasons so require.
- RAL® is an international independent colour standard system partner for industry, trade, architecture and design. Should be consulted before placing any order.
- The colours shown on this catalogue are only a reference and an illustration of the products finishing. The colours shown are not binding because brightness, contrast and colour balance may vary due to the printing process.
- Colours may vary due to raw-material suppliers' changes and some differences may occur in tonal range.
- Typical Indoor Comfort Standards state a temperature range of 20°C - 27°C (68°F - 81°F), and a relative humidity of less than 60%. These would be considered as normal operational levels of JOCAVI® products' range.
- Sizes may vary slightly due to their production method and some inherent raw-materials characteristics.



RIPPLE® DIFFUSION PANEL



Image of 60x60cm model Ref.:RPL060.

DESCRIPTION

The RIPPLE® was especially designed to have both absorption and diffusion features, balancing these two assets perfectly. It has a great diffusion pattern as well as very interesting and particular absorption characteristics.

The RIPPLE® is an essential product when you require a magnificent and controlled high-frequency sound, adding at the same time some absorption to the mid-range of the sound spectrum.

The RIPPLE® enables us to create uniform surfaces with a single model that softly absorbs the sound waves while maintaining the vivacity of the musical instruments' harmonics, which is very important for live and recording mixing techniques.

Thus, if you are looking for a superb sound in a room, without compromising absorption, you will certainly reach the required acoustics with this product, by adding a few pieces of low-frequencies bass traps as well.

The most suitable application areas for this product are: music studio rooms, piano and acoustic instruments rooms, live rooms in general, auditoriums, theatres as well as all the spaces that need specific care on sound intelligibility.

FEATURES

- Manufactured with HIPS and high-quality fabric.
- Average diffusion: **0.59/m²** [$>100\text{Hz}; <5\text{KHz}$].
- NRC: **0.39/m²** [$>250\text{Hz}; <10\text{KHz}$].
- Fire-resistance: VO - UL94 standards (similar to M2).
- Recyclable.
- Installation: accessories included.
- Several colours available.

TECHNICAL DRAWINGS

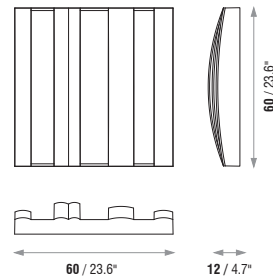

MODELS AND SIZES

MODELS	HEIGHT	WIDTH	DEPTH	WEIGHT
RPL060	60 cm (23.6 in)	60 cm (23.6 in)	12 cm (4.7 in)	4.5 Kg (9.92 lbs)

DIFFUSION - ABSORPTION COEFFICIENT

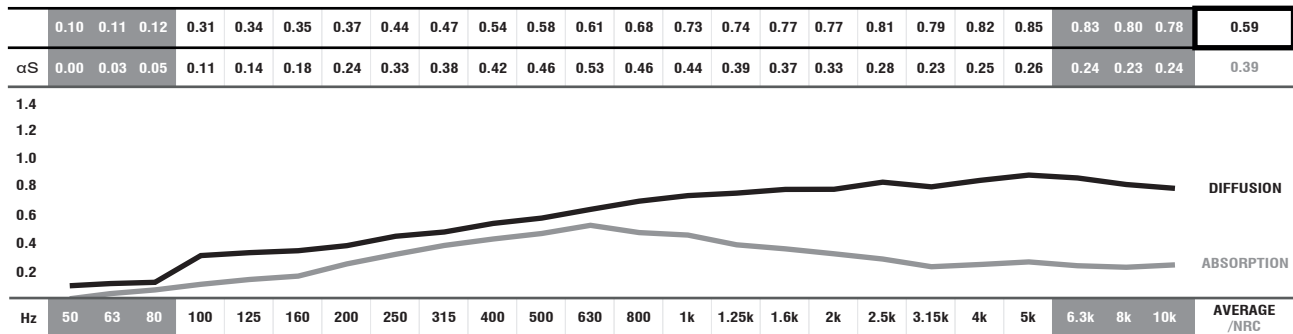

■ ABSORPTION COEFFICIENT: Values in accordance with the standards: EN 20654, ASTM C423 and EN 11654. ■ Values [$<100\text{Hz}$ and $>5\text{K}$] are Non Standard Values.
 ■ DIFFUSION COEFFICIENT: These values were obtained by mathematical calculations and tests carried out in our laboratory.

STANDARD HIPS COLOURS

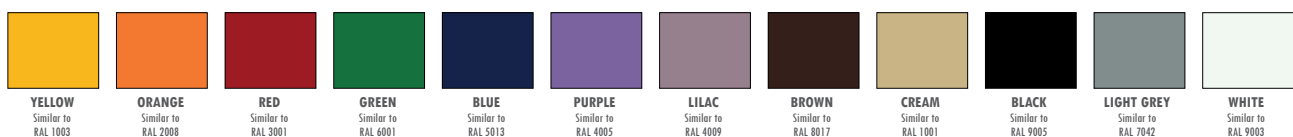

IMPORTANT NOTICES

- JOCAVI® accepts no responsibility for any printing errors. Specifications can be modified without prior notice, if technical or commercial reasons so require.
- RAL® is an international independent colour standard system partner for industry, trade, architecture and design. Should be consulted before placing any order.
- The colours shown on this catalogue are only a reference and an illustration of the products finishing. The colours shown are not binding because brightness, contrast and colour balance may vary due to the printing process.
- Colours may vary due to raw-material suppliers' changes and some differences may occur in tonal range.
- Typical Indoor Comfort Standards state a temperature range of 20°C - 27°C (68°F - 81°F), and a relative humidity of less than 60%. These would be considered as normal operational levels of JOCAVI® products' range.
- Sizes may vary slightly due to their production method and some inherent raw-materials characteristics.



SQUARYDIFFUSOR®

DIFFUSION PANEL



Image of 60x60cm model Ref. SQA060.

DESCRIPTION

The SQUARYDIFFUSOR® is a diffusion panel that has a higher balance between diffusion/absorption. It is a 2D quadratic diffuser with five slightly uneven gradients. The SQUARYDIFFUSOR® is made of ceramic.

Due to its quadratic shape and the raw material it uses, its diffusion and absorption features are well balanced for a diffusion panel.

The SQUARYDIFFUSOR® enables quite good control of acoustics by fragmenting the reflected energy, while the absorption factor is not too high, therefore quite recommended for installation in small-sized rooms, by making the acoustics of those spaces quite homogeneous.

This product is also available in individual tiles mainly proposed for big diffusion surfaces, with continuous coating (see more SQA15); it's an ideal product to the construction market.

TECHNICAL DRAWINGS

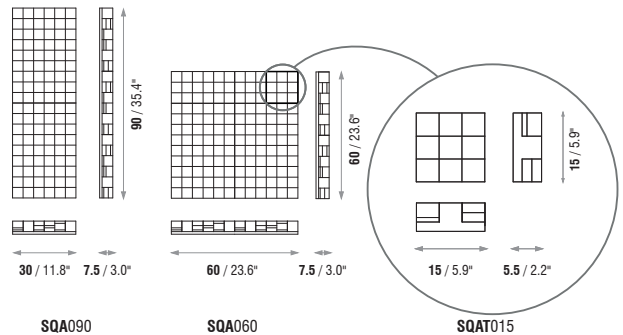

FEATURES

- Manufactured with ceramic.
- Average diffusion: $0.57/m^2$ [$>100Hz$; $<5KHz$].
- NRC: $0.22/m^2$ [$>250Hz$; $<10KHz$].
- Fire-resistance: Euroclass A1 (similar to old M0).
- 100% recyclable.
- Installation: accessories included.

MODELS AND SIZES

MODELS	HEIGHT	WIDTH	DEPTH	WEIGHT
SQA090	90 cm (35.4 in)	30 cm (11.8 in)	7.5 cm (3.0 in)	11.6 Kg (25.57 lbs)
SQA060	60 cm (23.6 in)	60 cm (23.6 in)	7.5 cm (3.0 in)	15.4 Kg (33.95 lbs)
SQA15	15 cm (5.9 in)	15 cm (5.9 in)	5.5 cm (2.2 in)	0.6 Kg (1.32 lbs)

DIFFUSION - ABSORPTION COEFFICIENT

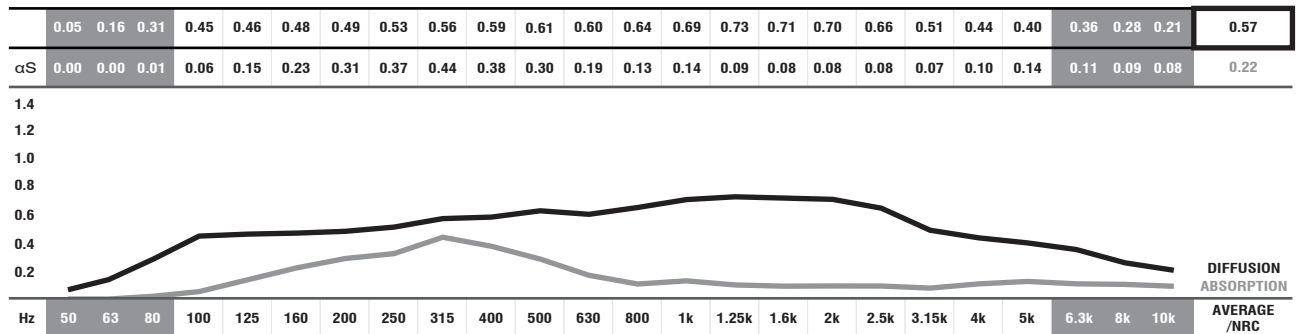

- ABSORPTION COEFFICIENT: Values in accordance with the standards: EN 20654, ASTM C423 and EN 11654.
- DIFFUSION COEFFICIENT: These values were obtained by mathematical calculations and tests carried out in our laboratory.

STANDARD CERAMIC COLOURS

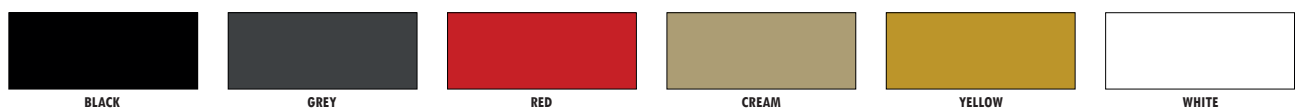

IMPORTANT NOTICES

- JOCAVI® accepts no responsibility for any printing errors. Specifications can be modified without prior notice, if technical or commercial reasons so require.
- The colours shown on this catalogue are only a reference and an illustration of the products finishing. The colours shown are not binding because brightness, contrast and colour balance may vary due to the printing process.
- Colours may vary due to raw-material suppliers' changes and some differences may occur in tonal range.
- Sizes may vary slightly due to their production method and some inherent raw-materials characteristics.



TUNEFLECTOR®

DIFFUSION PANEL



Image of 60x60cm model Ref.:TNF060.

DESCRIPTION

JOCAVI® is presenting this design proposal on diffusion products which is not as common. This has been done on the basis of the positive aspects of complex-shaped diffusers and the tasks carried out in the field of diffusion, to the detriment of the usual numerical sequences that are repeated to build diffusers. When a diffuser has a complex structure, as opposed to the identical or retrograde repetitions, it adopts algorithms that originate a series of N elements, thus causing an optimal musical characteristic.

Numerically structured diffusers scatter the sound effectively but have some inherent associated absorption. This model is meant to be an acoustic diffuser with the best scattering features possible coupled with the lowest absorption coefficient.

This new model has abrupt joints with planes that lean on each other, which are always different, but do not cause big concavities or parallelisms.

Design was an ever present concern in the manufacture of this product, in order not to make it unwanted due to its shape, regardless of its obvious use.

TECHNICAL DRAWINGS

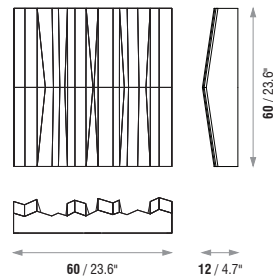

FEATURES

- Manufactured with HIPS.
- Average diffusion: **0.68/m²** [$>100\text{Hz}; <5\text{KHz}$].
- NRC: **0.12/m²** [$>250\text{Hz}; <10\text{KHz}$].
- Fire-resistance: VO - UL94 standards (similar to M2).
- 100% recyclable.
- Installation: accessories included.

MODELS AND SIZES

MODELS	HEIGHT	WIDTH	DEPTH	WEIGHT
TNF060	60 cm (23.6 in)	60 cm (23.6 in)	12 cm (4.7 in)	4.1 Kg (9.04 lbs)

DIFFUSION - ABSORPTION COEFFICIENT

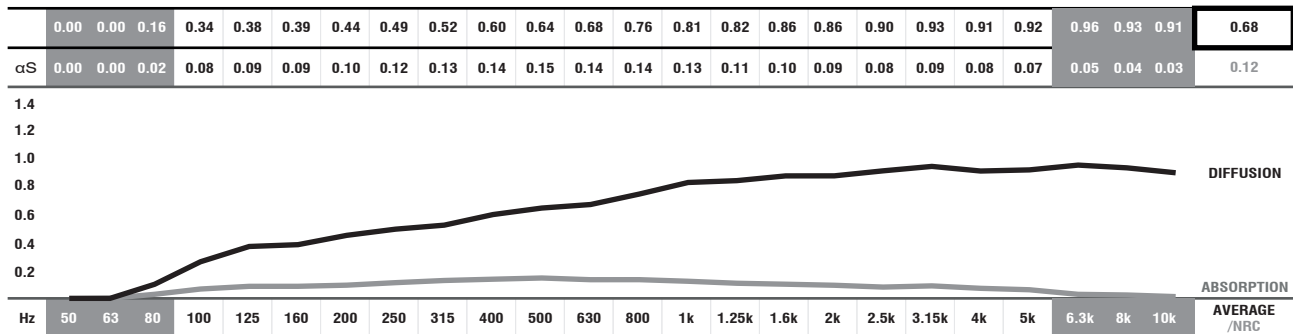

■ ABSORPTION COEFFICIENT: Values in accordance with the standards: EN 20654, ASTM C423 and EN 11654.

■ Values [$<100\text{Hz}$ and $> 5\text{K}$] are Non Standard Values.

■ DIFFUSION COEFFICIENT: These values were obtained by mathematical calculations and tests carried out in our laboratory.

STANDARD HIPS COLOURS

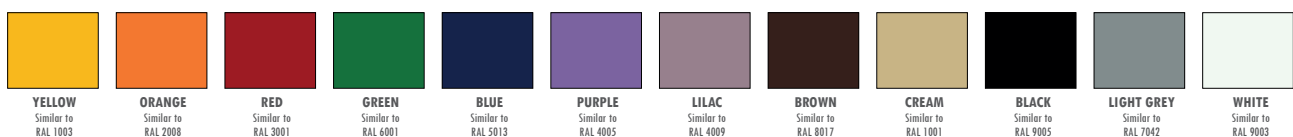

IMPORTANT NOTICES

- JOCAVI® accepts no responsibility for any printing errors. Specifications can be modified without prior notice, if technical or commercial reasons so require.
- RAL® is an international independent colour standard system partner for industry, trade, architecture and design. Should be consulted before placing any order.
- The colours shown on this catalogue are only a reference and an illustration of the products finishing. The colours shown are not binding because brightness, contrast and colour balance may vary due to the printing process.
- Colours may vary due to raw-material suppliers' changes and some differences may occur in tonal range.
- Typical Indoor Comfort Standards state a temperature range of 20°C - 27°C (68°F - 81°F), and a relative humidity of less than 60%. These would be considered as normal operational levels of JOCAVI® products' range.
- Sizes may vary slightly due to their production method and some inherent raw-materials characteristics.



TWO FX[®] DIFFUSION PANEL



Image of 60x60cm model Ref. TFX060.

DESCRIPTION

TWO[®]FX is an acoustic diffusion panel for High-End Studios and High-Performance room's applications.

The diffusion pattern is based on a sequence of the 7 musical notes followed by a mathematical routine of transpositions, inversions and retrogrades. The shapes of the component parts are predominantly convex, but there are also some concave, they never repeat the positioning before the end of the sequence of the notes' cadence.

During 5 years of the production of the TWO[®]FX, this model was made on HIPS. Now, JOCAVI[®] improves this model's characteristics using GRP as raw-material. This model updated on GRP, increases the mass that helps to improve his diffusion acoustic performance.

TWO[®]FX provides features of a beautiful diffusion surface with highly musical characteristics, simultaneously.

TECHNICAL DRAWINGS

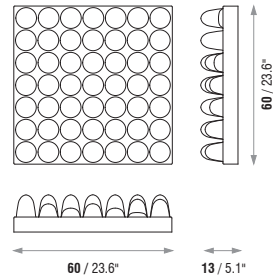

FEATURES

- Manufactured with GRP
- Average diffusion: **0.68/m²** [>100Hz; <5KHz].
- NRC: **0.21/m²** [>250Hz; <10KHz].
- Fire-resistance: B-s1,d0 (similar to old M1)
- 100% recyclable.
- Installation: accessories included.

MODELS AND SIZES

MODELS	HEIGHT	WIDTH	DEPTH	WEIGHT
TFX060	60 cm (23.6 in)	60 cm (23.6 in)	13 cm (5.1 in)	8.2 Kg (18.08 lbs)

DIFFUSION - ABSORPTION COEFFICIENT

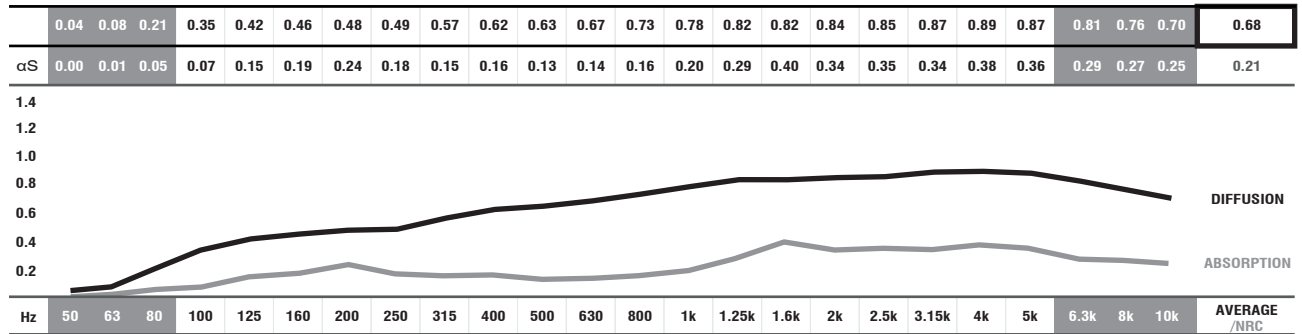

■ ABSORPTION COEFFICIENT: Values in accordance with the standards: EN 20654, ASTM C423 and EN 11654. ■ Values [<100Hz and > 5K] are Non Standard Values.
 ■ DIFFUSION COEFFICIENT: These values were obtained by mathematical calculations and tests carried out in our laboratory.

STANDARD GRP COLOURS

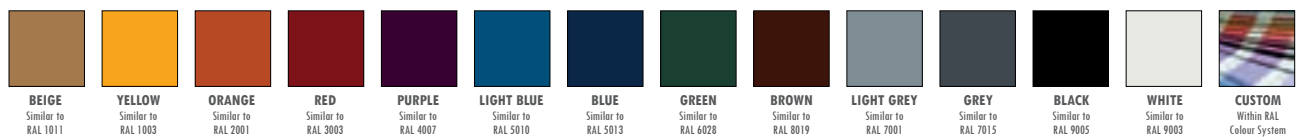

IMPORTANT NOTICES

- JOCAVI[®] accepts no responsibility for any printing errors. Specifications can be modified without prior notice, if technical or commercial reasons so require.
- RAL[®] is an international independent colour standard system partner for industry, trade, architecture and design. Should be consulted before placing any order.
- The colours shown on this catalogue are only a reference and an illustration of the products finishing. The colours shown are not binding because brightness, contrast and colour balance may vary due to the printing process.
- Colours may vary due to raw-material suppliers' changes and some differences may occur in tonal range.
- Typical Indoor Comfort Standards state a temperature range of 20°C - 27°C (68°F - 81°F), and a relative humidity of less than 60%. These would be considered as normal operational levels of JOCAVI[®] products' range.
- Sizes may vary slightly due to their production method and some inherent raw-materials characteristics.



WOODFOIL® / WOODFOIL® AB

DIFFUSION PANEL



Image of 60x60cm models Ref.:WFL060 and WFL060Ab (on the left) and 60cm Ref.:WFL060Ab (ambient image).

DESCRIPTION

The Woodfoil® is a slightly concave diffusion panel, made of varnished birch plywood on a soft wood structure.

This diffuser is great to be used in concert halls, such as theatres and auditoriums, and is ideal for building acoustic diffusion shells.

This model has two options: the Woodfoil® diffusion panel, which is made of plain birch plywood, and the Woodfoil®AB, which has different holes that provide it with a higher absorption coefficient.

Its format allows us to make the appropriate adjustment, by using several panels and positions through 90° rotations, in order to obtain the goals required for each room.

Both the angle and the gyrate of this piece were calculated to provide a more versatile use. When using multiple pieces jointly, the angle of incidence never is too convergent, thus providing a homogeneous scattering diffusion of sound energy, which contrasts with other models from our brand that have a different development conception.

The Woodfoil® is available in various wood finishings or regular colours, as an option, thus allowing an appropriate background for each space. The mounting process is rather easy by simply using the docking accessories that are supplied.

FEATURES

- Manufactured with Birch Plywood.
- Woodfoil® Average diffusion: **0.68/m²** [$> 100\text{Hz}; < 5\text{KHz}$].
- Woodfoil®AB Average diffusion: **0.51/m²** [$> 100\text{Hz}; < 5\text{KHz}$].
- **NRC: 0.23/m²** [$> 250\text{Hz}; < 10\text{KHz}$](WFL060); **0.62/m²** [$> 250\text{Hz}; < 10\text{KHz}$](WFL060AB).
- Fire-resistance: Euroclass B-s2,d0 (similar to old M1).
- Two options: Woodfoil® (diffusor) Woodfoil®AB (diffusion with absorption characteristics).
- Installation: accessories included.

TECHNICAL DRAWINGS

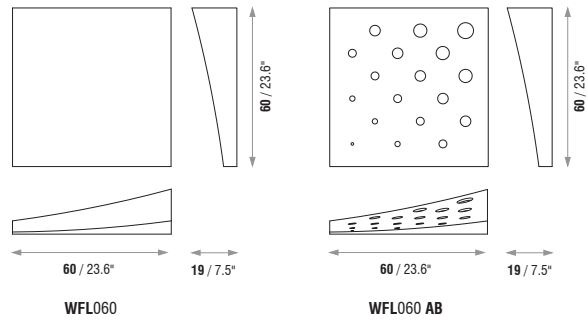

MODELS AND SIZES

MODELS	HEIGHT	WIDTH	DEPTH	WEIGHT
●● WFL060	60 cm (23.6 in)	60 cm (23.6 in)	19 cm (7.5 in)	2.9 Kg (6.39 lbs)
●● WFL060 AB	60 cm (23.6 in)	60 cm (23.6 in)	19 cm (7.5 in)	2.8 Kg (6.17 lbs)

DIFFUSION - ABSORPTION COEFFICIENT

Model	50	63	80	100	125	160	200	250	315	400	500	630	800	1k	1.25k	1.6k	2k	2.5k	3.15k	4k	5k	6.3k	8k	10k	NRC/AVERAGE
WFL060	0.02	0.05	0.08	0.28	0.38	0.47	0.56	0.60	0.68	0.71	0.77	0.79	0.80	0.83	0.81	0.78	0.79	0.78	0.76	0.77	0.75	0.74	0.72	0.70	0.68
αS	0.03	0.07	0.10	0.12	0.17	0.22	0.25	0.28	0.24	0.26	0.31	0.28	0.22	0.17	0.16	0.15	0.16	0.15	0.14	0.13	0.12	0.11	0.10	0.08	0.23
WFL060AB	0.01	0.04	0.06	0.20	0.28	0.32	0.38	0.42	0.44	0.50	0.61	0.63	0.65	0.64	0.62	0.59	0.57	0.54	0.55	0.58	0.59	0.55	0.57	0.56	0.51
αS	0.04	0.08	0.12	0.18	0.29	0.41	0.50	0.57	0.55	0.63	0.72	0.69	0.63	0.62	0.58	0.56	0.57	0.58	0.54	0.52	0.48	0.47	0.45	0.41	0.62

- ABSORPTION COEFFICIENT: Values in accordance with the standards: EN 20654, ASTM C423 and EN 11654.
- DIFFUSION COEFFICIENT: These values were obtained by mathematical calculations and tests carried out in our laboratory.

WOOD VENEER FINISHINGS



IMPORTANT NOTICES

- JOCAVI® accepts no responsibility for any printing errors. Specifications can be modified without prior notice, if technical or commercial reasons so require.
- The colours shown on this catalogue are only a reference and an illustration of the products finishing. The colours shown are not binding because brightness, contrast and colour balance may vary due to the printing process.
- Colours may vary due to raw-material suppliers' changes and some differences may occur in tonal range.
- Due to its natural origin, wood-based products will always present natural imperfections inherent to the organic nature. And for similar reasons, they will also present traces of old-age in the course of time.
- Wood and Fabric products are highly susceptible to change its appearance with humidity and temperature. Close attention must be paid to the storage conditions and the acclimatization before, during and after the installation.
- Typical Indoor Comfort Standards state a temperature range of 20°C - 27°C (68°F - 81°F), and a relative humidity of less than 60%. These would be considered as normal operational levels of JOCAVI® products' range.
- Despite all the standard sizes of all products, this model can be customised upon previous consultation. Sizes may vary slightly due to their production method and some inherent raw-materials characteristics.



WOODIFFUSOR®

DIFFUSION PANEL

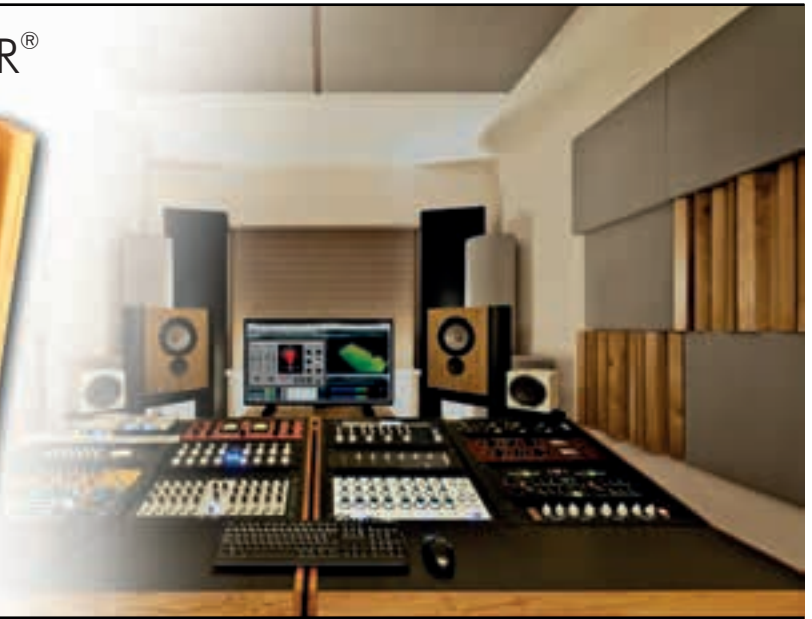

Image of 60x60cm model Ref.:WOD060.

DESCRIPTION

This wooden diffusion panel is the result of a long design and analysis process and one of JOCAVI's options in terms of diffusion panels. The use of this extremely efficient panel is imperative to control primary reflections and other reflections from front walls, thus improving correct sound diffusion in the room.

The WOODIFFUSOR® is a 2D diffusion panel that focuses on controlling horizontal dispersion and is efficient in a wide range of frequencies. It is based on the rotation sequence of primary incidence angles, thereby making sound diffusion uniform in several directions with similar energy.

This panel is made of solid pinewood with finishings available in five different colours of varnish. The wood stands out inside the rooms and makes this product look very attractive, both acoustically and aesthetically.

FEATURES

- Manufactured with self-sustainable forest wood.
- Average diffusion: **0.59/m²** [$>100\text{Hz}; <5\text{KHz}$].
- NRC: **0.19/m²** [$>250\text{Hz}; <10\text{KHz}$].
- Fire-resistance: Euroclass D-s1,d0 (similar to old M3).
- Finished with ecological varnishes.
- 100% recyclable.
- Installation: accessories included.

TECHNICAL DRAWINGS

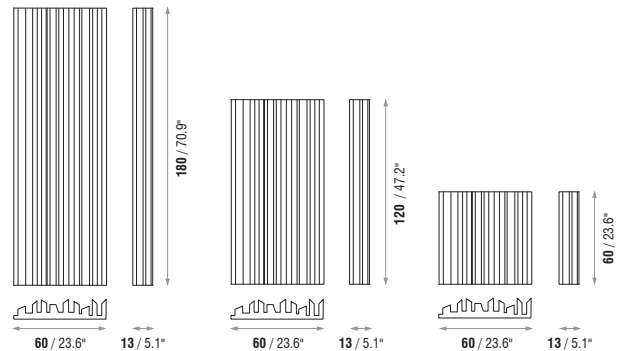

MODELS AND SIZES

MODELS	HEIGHT	WIDTH	DEPTH	WEIGHT
WOD180	180 cm (70.9 in)	60 cm (23.6 in)	13 cm (5.1 in)	57 Kg (125.66 lbs)
WOD120	120 cm (47.2 in)	60 cm (23.6 in)	13 cm (5.1 in)	38 Kg (83.78 lbs)
WOD060	60 cm (23.6 in)	60 cm (23.6 in)	13 cm (5.1 in)	19 Kg (41.89 lbs)

DIFFUSION - ABSORPTION COEFFICIENT

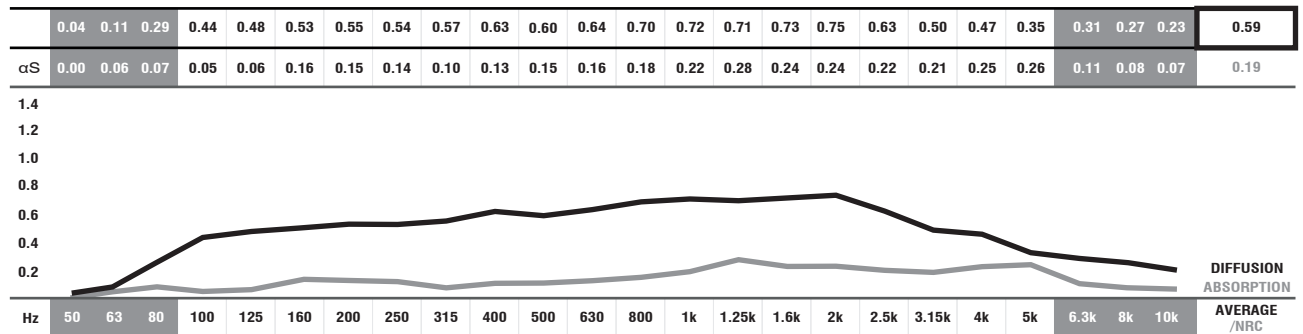

- ABSORPTION COEFFICIENT: Values in accordance with the standards: EN 20654, ASTM C423 and EN 11654.
- DIFFUSION COEFFICIENT: These values were obtained by mathematical calculations and tests carried out in our laboratory.

WOOD VENEER FINISHINGS



PINE



OAK



CHERRY



MAHOGANY



BLACK-BROWN



SUCUPIRA

IMPORTANT NOTICES

- JOCAVI® accepts no responsibility for any printing errors. Specifications can be modified without prior notice, if technical or commercial reasons so require.
- The colours shown on this catalogue are only a reference and an illustration of the products finishing. The colours shown are not binding because brightness, contrast and colour balance may vary due to the printing process.
- Colours may vary due to raw-material suppliers' changes and some differences may occur in tonal range.
- Due to its natural origin, wood-based products will always present natural imperfections inherent to the organic nature. And for similar reasons, they will also present traces of old-age in the course of time.
- Wood and Fabric products are highly susceptible to change its appearance with humidity and temperature. Close attention must be paid to the storage conditions and the acclimatization before, during and after the installation.
- Typical Indoor Comfort Standards state a temperature range of 20°C - 27°C (68°F - 81°F), and a relative humidity of less than 60%. These would be considered as normal operational levels of JOCAVI® products' range.
- Despite all the standard sizes of all products, this model can be customised upon previous consultation. Sizes may vary slightly due to their production method and some inherent raw-materials characteristics.



WOODQUAD®

DIFFUSION PANEL



Images of 60x60cm model Ref.:WQD060.

DESCRIPTION

The use of diffusor panels is imperative to control primary reflections and other reflections from flat surfaces, thus improving correct sound diffusion in the room.

The WOODQUAD® is a two-dimensional quadratic residue sound diffusor created to expand our product line anchored in classical designs. It is designed to provide a more uniform sound field through mid and high frequencies and offers us optimal hemispherical scattering for wide angles of incidence.

This wooden diffusion panel provides large spectrum bandwidth diffusion in a single integrated piece with minimal depth; it has the uniform scattering properties of a quadratic diffusor.

This panel is made of solid pinewood with a finish of five different colors of veneer. The wood stands out inside the rooms and makes this product look very attractive, both acoustically and aesthetically.

TECHNICAL DRAWINGS

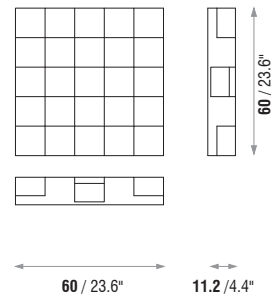

FEATURES

- Manufactured with self-sustainable forest natural wood.
- 2D RQD reflection phase grating.
- Average diffusion: **0.63/m²** [$>100\text{Hz}; <5\text{KHz}$].
- NRC: **0.19/m²** [$>250\text{Hz}; <10\text{KHz}$].
- Fire-resistance: Euroclass D-s1,d0 (similar to old M3).
- Finished with ecological veneers.
- 100% recyclable.
- Application on ceiling and walls.
- Installation: accessories included.

MODELS AND SIZES

MODELS	HEIGHT	WIDTH	DEPTH	WEIGHT
WQD060	60 cm (23.6 in)	60 cm (23.6 in)	11.2 cm (4.4 in)	19 Kg (41.89 lbs)

DIFFUSION - ABSORPTION COEFFICIENT

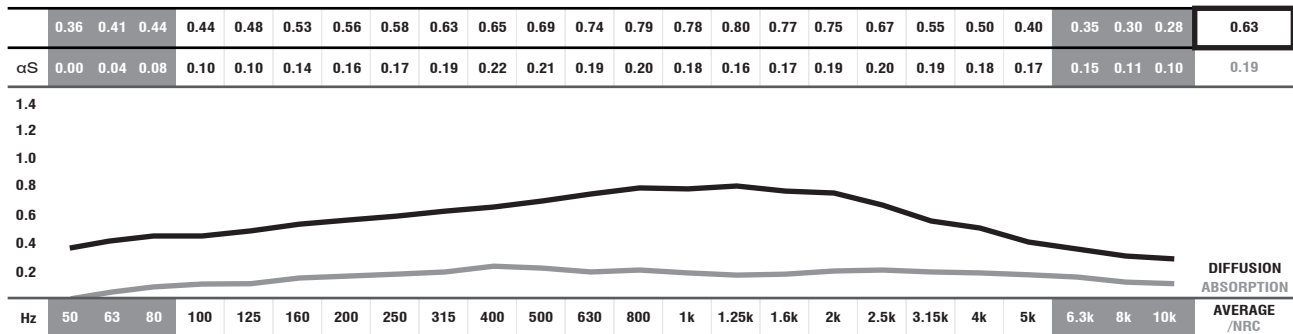

- ABSORPTION COEFFICIENT: Values in accordance with the standards: EN 20654, ASTM C423 and EN 11654.
- DIFFUSION COEFFICIENT: These values were obtained by mathematical calculations and tests carried out in our laboratory.

WOOD VENEER FINISHINGS



IMPORTANT NOTICES

- JOCAVI® accepts no responsibility for any printing errors. Specifications can be modified without prior notice, if technical or commercial reasons so require.
- The colours shown on this catalogue are only a reference and an illustration of the products finishing. The colours shown are not binding because brightness, contrast and colour balance may vary due to the printing process.
- Colours may vary due to raw-material suppliers' changes and some differences may occur in tonal range.
- Due to its natural origin, wood-based products will always present natural imperfections inherent to the organic nature. And for similar reasons, they will also present traces of old-age in the course of time.
- Wood and Fabric products are highly susceptible to change its appearance with humidity and temperature. Close attention must be paid to the storage conditions and the acclimatization before, during and after the installation.
- Typical Indoor Comfort Standards state a temperature range of 20°C - 27°C (68°F - 81°F), and a relative humidity of less than 60%. These would be considered as normal operational levels of JOCAVI® products' range.
- Despite all the standard sizes of all products, this model can be customised upon previous consultation. Sizes may vary slightly due to their production method and some inherent raw-materials characteristics.



CORALREEF®

DIFFUSION PANEL

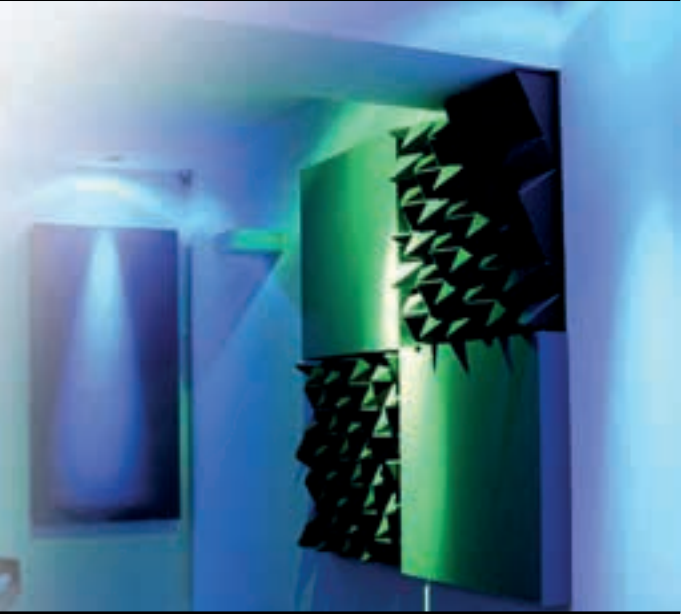

Image of 60x60cm model Ref.:COR060.

DESCRIPTION

The CORALREEF® is a 3D controlled dispersion acoustic diffusion panel. It is made of high-density polystyrene and its finishing membrane provides it with the intended acoustic qualities.

Its angular appearance gives dynamics to any space and provides a decorative effect and attractive combinations.

This acoustic panel is installed on ceilings and walls. Its low weight makes it the ideal product for use on false ceilings, on its own or alternated with flat modules when refinement and quality are required.

The calculation basis was the theoretical numerical sequence ratio of the primitive root, thus providing excellent results of sound diffusion in all directions. The depth factor is logarithmically varied, and it is, therefore, a three-dimension omnidirectional reflection panel. Due to its quite sinuous shape with deep recesses, as well as the raw material it is made of, this product also has a considerable associated absorption coefficient. Is the top model of ATP® diffusers set.

TECHNICAL DRAWINGS

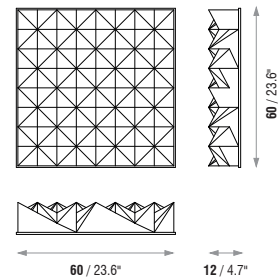

FEATURES

- Manufactured with High-Density EPS.
- Average diffusion: **0.68/m²** [$> 100\text{Hz}; < 5\text{KHz}$].
- NRC: **0.28/m²** [$> 250\text{Hz}; < 10\text{KHz}$].
- Fire resistance: Euroclass B-s3,d1 (similar to old M1).
- Finished with an ecological paint.
- 100% recyclable.

MODELS AND SIZES

MODELS	HEIGHT	WIDTH	DEPTH	WEIGHT
COR060	60 cm (23.6 in)	60 cm (23.6 in)	12 cm (4.7 in)	1.9 Kg (4.19 lbs)

DIFFUSION - ABSORPTION COEFFICIENT

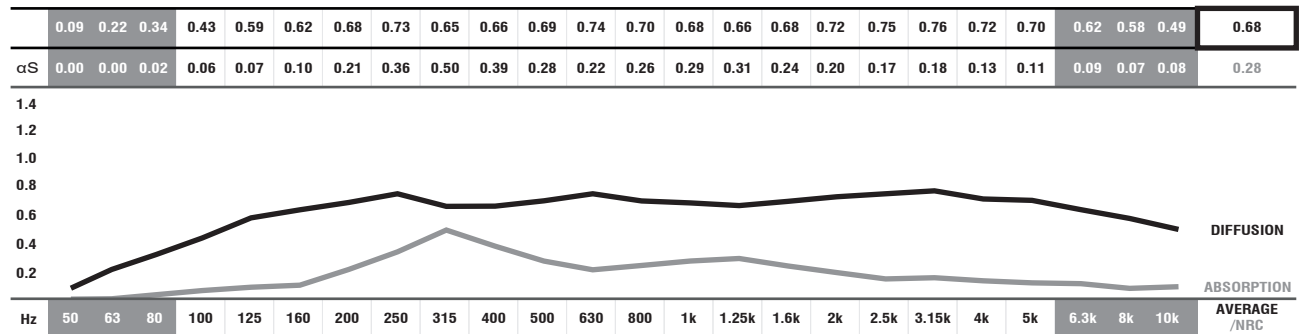

■ ABSORPTION COEFFICIENT: Values in accordance with the standards: EN 20654, ASTM C423 and EN 11654. ■ Values [$< 100\text{Hz}$ and $> 5\text{K}$] are Non Standard Values.
 ■ DIFFUSION COEFFICIENT: These values were obtained by mathematical calculations and tests carried out in our laboratory.

STANDARD EPS RAL COLOURS



IMPORTANT NOTICES

- JOCAVI® accepts no responsibility for any printing errors. Specifications can be modified without prior notice, if technical or commercial reasons so require.
- RAL® is an international independent colour standard system partner for industry, trade, architecture and design. Should be consulted before placing any order.
- The colours shown on this catalogue are only a reference and an illustration of the products finishing. The colours shown are not binding because brightness, contrast and colour balance may vary due to the printing process.
- Colours may vary due to raw-material suppliers' changes and some differences may occur in tonal range.
- Typical Indoor Comfort Standards state a temperature range of 20°C - 27°C (68°F - 81°F), and a relative humidity of less than 60%. These would be considered as normal operational levels of JOCAVI® products' range.
- Sizes may vary slightly due to their production method and some inherent raw-materials characteristics.



IVORY®
DIFFUSION PANEL



Image of 60x60cm model Ref.:IV0060.

DESCRIPTION

The IVORY® is a 2D controlled dispersion diffusion panel in a single coordinate. It is made of high-density EPS covered with a hardened layer. This design gives this product the intended acoustic diffusion properties. It is therefore one more option within the range of diffusers presented by ATP®.

Its convex external geometry with seven longitudinal incisions provides a decorative effect and attractive combinations with the absorption panel EBONY®.

The use of this extremely dynamic panel is crucial to control early reflections and other reflections from walls, thus improving control of sound diffusion in the room.

Due to its shape, with deep recesses, this product also has an interesting related absorption coefficient.

This acoustic panel is installed on walls and ceilings. Its low weight makes its installation on ceilings quite practical.

TECHNICAL DRAWINGS

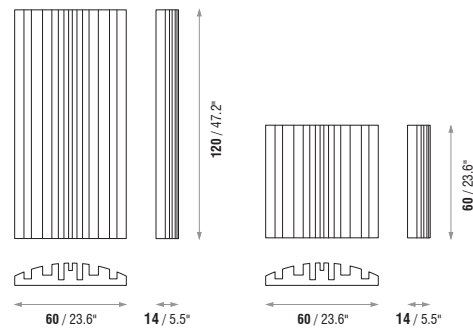

FEATURES

- Manufactured with High-density EPS.
- Average diffusion: **0.67/m²** [$>100\text{Hz}$; $<5\text{KHz}$].
- NRC: **0.27/m²** [$>250\text{Hz}$; $<10\text{KHz}$].
- Fire resistance: Euroclass B-s3,d1 (similar to old M1).
- Finished with an ecological paint.
- 100% recyclable.

MODELS AND SIZES

MODELS	HEIGHT	WIDTH	DEPTH	WEIGHT
IV0120	120 cm (47.2 in)	60 cm (23.6 in)	14 cm (5.5 in)	4.8 Kg (10.58 lbs)
IV0060	60 cm (23.6 in)	60 cm (23.6 in)	14 cm (5.5 in)	2.4 Kg (5.29 lbs)

DIFFUSION - ABSORPTION COEFFICIENT

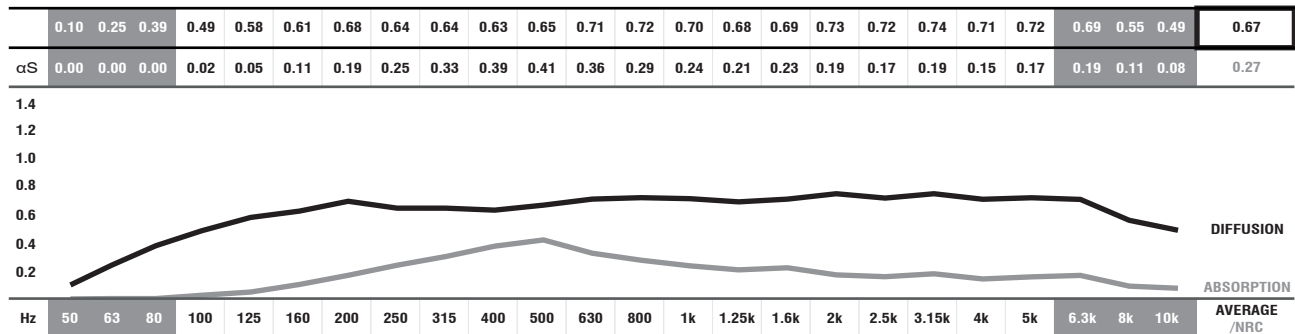

■ ABSORPTION COEFFICIENT: Values in accordance with the standards: EN 20654, ASTM C423 and EN 11654.

■ Values [$<100\text{Hz}$ and $>5\text{K}$] are Non Standard Values.

■ DIFFUSION COEFFICIENT: These values were obtained by mathematical calculations and tests carried out in our laboratory.

STANDARD EPS RAL COLOURS

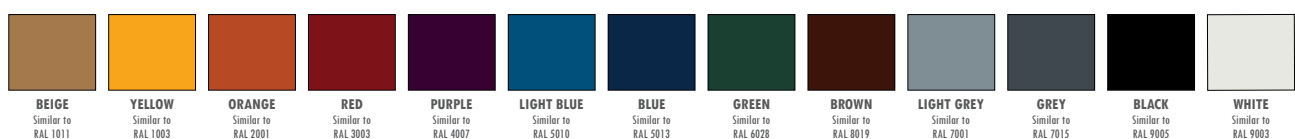

IMPORTANT NOTICES

- JOCAVI® accepts no responsibility for any printing errors. Specifications can be modified without prior notice, if technical or commercial reasons so require.
- RAL® is an international independent colour standard system partner for industry, trade, architecture and design. Should be consulted before placing any order.
- The colours shown on this catalogue are only a reference and an illustration of the products finishing. The colours shown are not binding because brightness, contrast and colour balance may vary due to the printing process.
- Colours may vary due to raw-material suppliers' changes and some differences may occur in tonal range.
- Typical Indoor Comfort Standards state a temperature range of 20°C - 27°C (68°F - 81°F), and a relative humidity of less than 60%. These would be considered as normal operational levels of JOCAVI® products' range.
- Sizes may vary slightly due to their production method and some inherent raw-materials characteristics.



REFLEX[®]

DIFFUSION PANEL



Image of 60x60cm model Ref.:RFL060 (on the left) and Ref.:RFL060 applied (ambient image).

DESCRIPTION

The REFLEX[®] represents another option on acoustic diffusers, thus allowing different aesthetic and performance possibilities. It is made of high-quality 100% recyclable ecologic EPS raw material. It is used on side or back walls to blend the direct and early reflected sound, thus increasing speech intelligibility and enhancing musical clarity.

This diffusion panel offers optimal shape and more omnidirectional scattering diffusion than traditional, non-optimised panels do. It is a very good cost-effective choice for a 2D sound diffuser.

TECHNICAL DRAWINGS

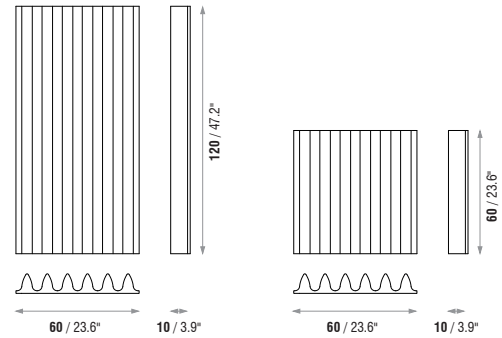

FEATURES

- Average diffusion: **0.50/m²** [$> 100\text{Hz}; < 5\text{KHz}$].
- NRC: **0.26/m²** [$> 250\text{Hz}; < 10\text{KHz}$].
- Fire resistance: Euroclass B-s3,d1 (similar to old M1).
- Finished with an ecological paint.
- Very easy to install.
- Other colours available upon consultation.

MODELS AND SIZES

MODELS	HEIGHT	WIDTH	DEPTH	WEIGHT
RFL120	120 cm (47.2 in)	60 cm (23.6 in)	10 cm (3.9 in)	1.6 Kg (3.53 lbs)
RFL060	60 cm (23.6 in)	60 cm (23.6 in)	10 cm (3.9 in)	0.8 Kg (1.76 lbs)

DIFFUSION - ABSORPTION COEFFICIENT

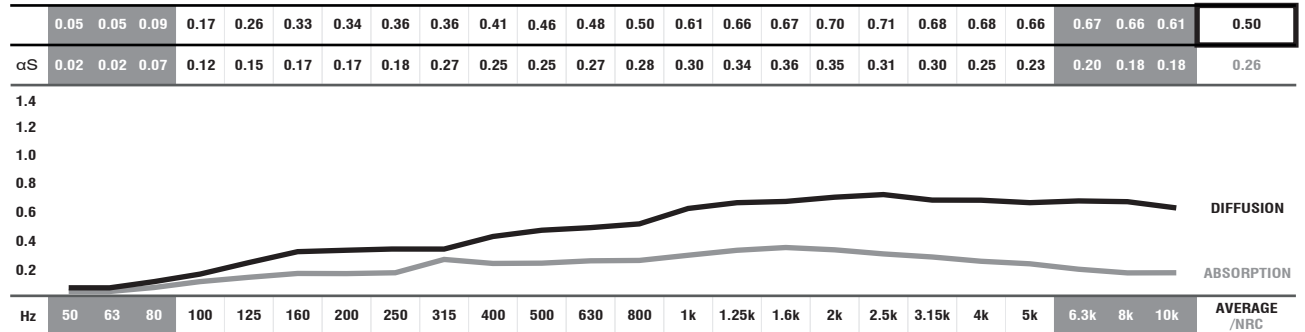

- ABSORPTION COEFFICIENT: Values in accordance with the standards: EN 20654, ASTM C423 and EN 11654.
- DIFFUSION COEFFICIENT: These values were obtained by mathematical calculations and tests carried out in our laboratory.

STANDARD EPS RAL COLOURS



IMPORTANT NOTICES

- JOCAVI[®] accepts no responsibility for any printing errors. Specifications can be modified without prior notice, if technical or commercial reasons so require.
- RAL[®] is an international independent colour standard system partner for industry, trade, architecture and design. Should be consulted before placing any order.
- The colours shown on this catalogue are only a reference and an illustration of the products finishing. The colours shown are not binding because brightness, contrast and colour balance may vary due to the printing process.
- Colours may vary due to raw-material suppliers' changes and some differences may occur in tonal range.
- Typical Indoor Comfort Standards state a temperature range of 20°C - 27°C (68°F - 81°F), and a relative humidity of less than 60%. These would be considered as normal operational levels of JOCAVI[®] products' range.
- Sizes may vary slightly due to their production method and some inherent raw-materials characteristics.



STRIPEFUSER®

DIFFUSION PANEL



Image of 60x60cm model Ref.:STF060 (on the left) and Ref.:STF060 and STF120 applied (ambient image).

DESCRIPTION

The STRIPEFUSER® acoustic panel is the least expensive model of diffusers from our brand. It has a striped shape and is made of high-quality 100% recyclable ecologic EPS raw material.

This model can be combined with the STRIPESORB®; as a result, two different acoustic areas keep maintaining the same shape.

The STRIPEFUSER® offers associate absorption because the uniform protruding stripes make the sound to enter directly into the concavities. This product offers uniform unidirectional diffusion and provides an attractive design to ceilings and walls.

It is a cost-effective diffuser as an alternative to other more expensive diffusion panels.

TECHNICAL DRAWINGS

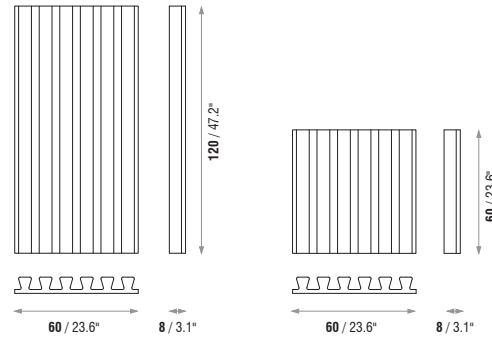

FEATURES

- Average diffusion: **0.52/m²** [$>100\text{Hz}; <5\text{KHz}$].
- NRC: **0.26/m²** [$>250\text{Hz}; <10\text{KHz}$].
- Fire resistance: Euroclass B-s3,d1 (similar to old M1).
- Finished with an ecological paint.
- Very easy to install.
- Other colours available upon consultation.

MODELS AND SIZES

MODELS	HEIGHT	WIDTH	DEPTH	WEIGHT
STF120	120 cm (47.2 in)	60 cm (23.6 in)	8 cm (3.1 in)	1.5 Kg (3.31 lbs)
STF060	60 cm (23.6 in)	60 cm (23.6 in)	8 cm (3.1 in)	0.6 Kg (1.32 lbs)

DIFFUSION - ABSORPTION COEFFICIENT

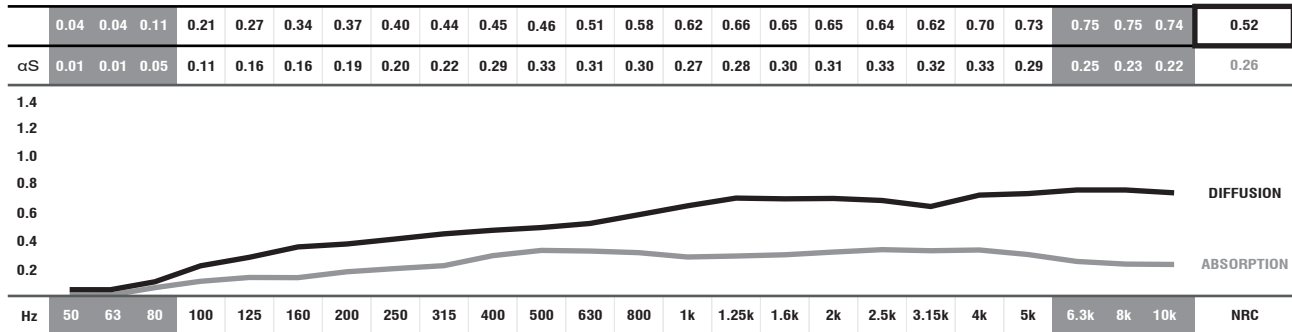

- ABSORPTION COEFFICIENT: Values in accordance with the standards: EN 20654, ASTM C423 and EN 11654. ■ Values [$<100\text{Hz}$ and $> 5\text{K}$] are Non Standard Values.
- DIFFUSION COEFFICIENT: These values were obtained by mathematical calculations and tests carried out in our laboratory.

STANDARD EPS RAL COLOURS



IMPORTANT NOTICES

- JOCAVI® accepts no responsibility for any printing errors. Specifications can be modified without prior notice, if technical or commercial reasons so require.
- RAL® is an international independent colour standard system partner for industry, trade, architecture and design. Should be consulted before placing any order.
- The colours shown on this catalogue are only a reference and an illustration of the products finishing. The colours shown are not binding because brightness, contrast and colour balance may vary due to the printing process.
- Colours may vary due to raw-material suppliers' changes and some differences may occur in tonal range.
- Typical Indoor Comfort Standards state a temperature range of 20°C - 27°C (68°F - 81°F), and a relative humidity of less than 60%. These would be considered as normal operational levels of JOCAVI® products' range.
- Sizes may vary slightly due to their production method and some inherent raw-materials characteristics.



TWIN®

DIFFUSION AND ABSORBENT PANEL

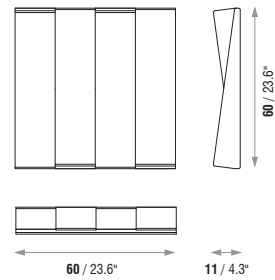

Image of 60x60cm model Ref.:TWN060 (on the left) and Ref.:TWN060 applied (ambient image).

DESCRIPTION

TWIN® is an Absorbent and Diffuser element and it was designed to combine both features, balancing these two assets perfectly in an aesthetically symmetrical way. TWIN® enables the creation of uniform surfaces with a single model that softly absorbs the sound waves while maintaining the vivacity of the musical instruments' harmonics, which is vital for the music's natural acoustic environment. TWIN® has a great combination of absorption and diffusion patterns and it is an essential product when you require a better control of high-frequencies, adding at the same time some absorption to the mid-range of the sound spectrum. An excess of absorption elements in a room can cause the overtones manifested at the higher frequencies to be canceled out, it becomes imperative to use acoustic diffusers. Thus, if you are looking for a superb sound in a room, without compromising absorption, you will certainly reach the required acoustics with this product, by adding a few pieces of low-frequency bass traps as well. The most suitable application areas for this product are: music studio rooms, piano and acoustic instruments rooms, live rooms in general,

TECHNICAL DRAWINGS



TWN060

FEATURES

- Manufactured with HIPS, Melamine Foam with velvet finishing.
- Average diffusion: **0.61/m²** [$>100\text{Hz}; <5\text{KHz}$].
- NRC: **0.70/m²** [$>250\text{Hz}; <10\text{KHz}$].
- HIPS - Fire-resistance: VO - UL94 standards (similar to M2).
- MELAMINE FOAM - Flame resistance: Euroclass B-s1,d0 (similar to old M1 France, Germany B1,GB class1, USA V0/HF1).
- Recyclable.
- Installation: accessories included.
- Several colours available.

MODELS AND SIZES

MODELS	HEIGHT	WIDTH	DEPTH	WEIGHT
TWN060	60 cm (23.6 in)	60 cm (23.6 in)	11 cm (4.3 in)	4.4 Kg (15.7 lbs)

DIFFUSION - ABSORPTION COEFFICIENT

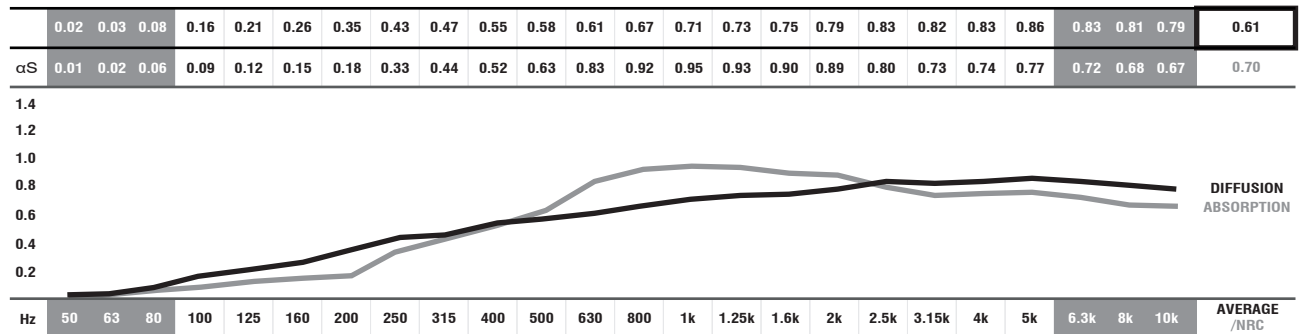

■ ABSORPTION COEFFICIENT: Values in accordance with the standards: EN 20654, ASTM C423 and EN 11654. ■ Values [$<100\text{Hz}$ and $>5\text{K}$] are Non Standard Values.
 ■ DIFFUSION COEFFICIENT: These values were obtained by mathematical calculations and tests carried out in our laboratory.

STANDARD HIPS COLOURS



YELLOW Similar to RAL 1003
ORANGE Similar to RAL 2008
RED Similar to RAL 3001
GREEN Similar to RAL 6001
BLUE Similar to RAL 5013
PURPLE Similar to RAL 4005
LILAC Similar to RAL 4009
BROWN Similar to RAL 8017
CREAM Similar to RAL 1001
BLACK Similar to RAL 9005
GREY Similar to RAL 7042
WHITE Similar to RAL 9003

VELVETY COLOURS



RED **BLUE** **GREY** **BEIGE** **BLACK** **WHITE**

IMPORTANT NOTICES

- JOCAVI® accepts no responsibility for any printing errors. Specifications can be modified without prior notice, if technical or commercial reasons so require.
- RAL® is an international independent colour standard system partner for industry, trade, architecture and design. Should be consulted before placing any order.
- The colours shown on this catalogue are only a reference and an illustration of the products finishing. The colours shown are not binding because brightness, contrast and colour balance may vary due to the printing process.
- Colours may vary due to raw-material suppliers' changes and some differences may occur in tonal range.
- Typical indoor Comfort Standards state a temperature range of 20°C - 27°C (68°F - 81°F), and a relative humidity of less than 60%. These would be considered as normal operational levels of JOCAVI® products' range.
- Sizes may vary slightly due to their production method and some inherent raw-materials characteristics.



WAVYFUSER® /INVERTED

DIFFUSION PANEL



Image of 60x60cm models Ref.:WAV060 and Ref.:WAI060 (on the left) and Ref.:WAV120 and Ref.:WAI120 applied (ambient image).

DESCRIPTION

The WAVYFUSER INV® is made of high-quality 100% recyclable ecologic EPS raw material. This design results from combining a sequence of concave and convex shapes with numerical techniques, which creates a profile surface that optimises the scattering of diffusion.

This model has two different varieties, male and female, which, when combined in the assembly, make the diffusion of medium/low frequencies more efficient. Acoustically, this translates into a more real control of sound reflections in your room, by providing uniform omnidirectional broad bandwidth diffusion without any other unwanted sound effect in the room.

The WAVYFUSER INV® is one of the top model of ATP® diffusers set. Its price is highly reasonable and provides a combination of hemispherical acoustic diffusion with a top-quality EPS finishing painting.

FEATURES

- Average diffusion: **0.57/m²** [$>100\text{Hz}; <5\text{KHz}$].
- NRC: **0.21/m²** [$>250\text{Hz}; <10\text{KHz}$].
- Fire resistance: Euroclass B-s3,d1 (similar to old M1).
- Finished with an ecological paint.
- Very easy to install.
- Other colours available upon consultation.
- Sold in pairs.

TECHNICAL DRAWINGS

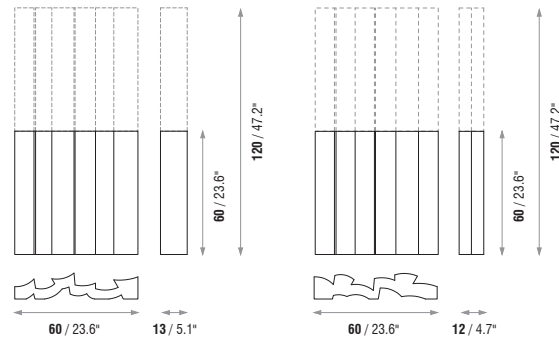

MODELS AND SIZES

MODELS	HEIGHT	WIDTH	DEPTH	WEIGHT
WAV120	120 cm (47.2 in)	60 cm (23.6 in)	13 cm (5.1 in)	2 Kg (4.41 lbs)
WAI120	120 cm (47.2 in)	60 cm (23.6 in)	12 cm (4.7 in)	2.2 Kg (4.85 lbs)
WAV060	60 cm (23.6 in)	60 cm (23.6 in)	13 cm (5.1 in)	1 Kg (2.20 lbs)
WAI060	60 cm (23.6 in)	60 cm (23.6 in)	12 cm (4.7 in)	1.1 Kg (2.43 lbs)

SOLD IN PAIRS

DIFFUSION - ABSORPTION COEFFICIENT

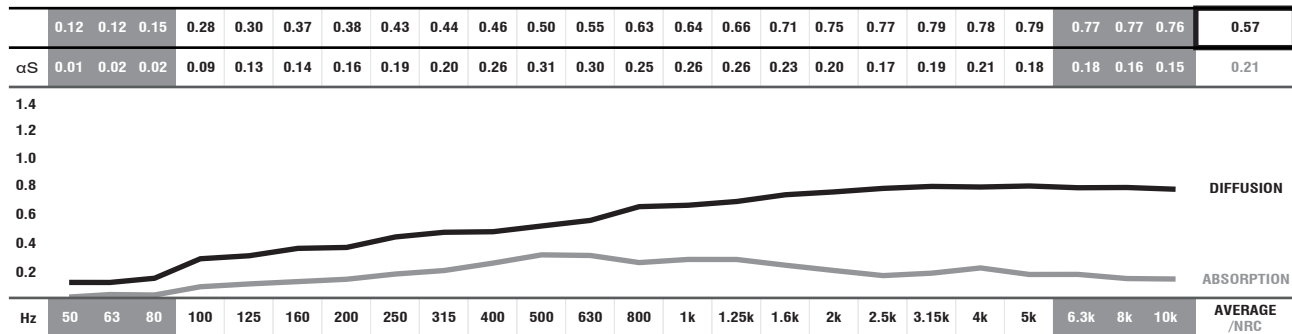

■ ABSORPTION COEFFICIENT: Values in accordance with the standards: EN 20654, ASTM C423 and EN 11654. ■ Values [$<100\text{Hz}$ and $>5\text{K}$] are Non Standard Values.
 ■ DIFFUSION COEFFICIENT: These values were obtained by mathematical calculations and tests carried out in our laboratory.

STANDARD EPS RAL COLOURS

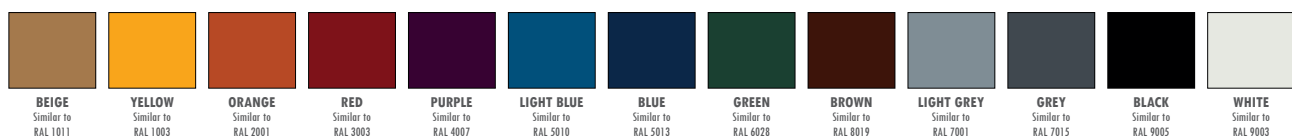

IMPORTANT NOTICES

- JOCAVI® accepts no responsibility for any printing errors. Specifications can be modified without prior notice, if technical or commercial reasons so require.
- RAL® is an international independent colour standard system partner for industry, trade, architecture and design. Should be consulted before placing any order.
- The colours shown on this catalogue are only a reference and an illustration of the products finishing. The colours shown are not binding because brightness, contrast and colour balance may vary due to the printing process.
- Colours may vary due to raw-material suppliers' changes and some differences may occur in total range.
- Typical Indoor Comfort Standards state a temperature range of 20°C - 27°C (68°F - 81°F), and a relative humidity of less than 60%. These would be considered as normal operational levels of JOCAVI® products' range.
- Sizes may vary slightly due to their production method and some inherent raw-materials characteristics.



ABSTRACT®

TUNED LF ABSORPTION PANEL



LARGE-SIZED
LOW
FREQUENCY
ABSORBENTS



ADJUSTABLE PRESSURE



MOUNTING DETAIL

Image of 200x100x20cm model Ref.:BSW200 and 100x100x20cm model Ref.:BSW100(on the left) and Ref.:BSW200 applied (ambient image).

DESCRIPTION

The creation of this bass trap patent and its manufacturing method consists of a very solid box, on which a bitumen elastic layer on each of the two sides is applied. The resonator's absorbing surfaces are thin massive plates: the front one with high elasticity and low internal friction and the back plate with less elasticity causing a high internal friction. This combination creates an all-over solid connection through the metal box between the front and back plates. This compound forms a box sealed all around, closed to the air pressure, but opened to the sound. The front and the back plates do not prevent the entering of low frequencies from going inside the box interacting with a different air pressure. Like a tunable Helmholtz resonator, the membrane is excited by the resonance frequency and it vibrates so strong that the weight of the limp mass pushes and pulls the air cushion inside the box.

The ABSTRACT® resonance box formula comprises two limp elastic masses separated by the distance between them, benefiting the isothermal compression, thus providing better sensibility by absorbing the low-end frequencies at very low sound pressure levels. This system is very sensitive, however, the louder the sound system is, pumping the volume up, the more absorption you can get. Consequently it is an incredible high-efficiency low-frequency absorber panel.

By using a simple air compressor device you are free to vary and change the internal air pressure, hence obtaining various different frequencies of absorption. The distance between the membranes

varies according to the internal air pressure difference; for example with positive air pressurization we have a bigger distance and the air pressure superior to the original exterior pressure. As result, the frequency varies in accordance with the mentioned frequencies pattern.

In a more or less intense way, the problem of the low-frequencies control is widespread in most room types; This model is ideal for Concert venues, Auditoriums, Pavilions, studios, music rooms; these are the type of rooms that can greatly benefit from the integration of these acoustic modules, once they are the most effective and accurate way to intervene in solving the problems of low-frequencies.

MODELS AND SIZES

MODELS	HEIGHT	WIDTH	DEPTH	WEIGHT
BSW200	200 cm (78.7 in)	100 cm (39.4 in)	20 cm (7.9 in)	45 Kg (99.21 lbs)
BSW100	100 cm (39.4 in)	100 cm (39.4 in)	20 cm (7.9 in)	24 Kg (52.91 lbs)

TECHNICAL DRAWINGS

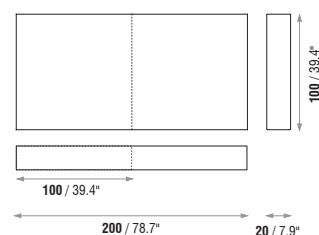

FEATURES

- Uses 60% of recycled materials and 100% recyclable.
- Fire-resistance: Euroclass B (similar to old M1).
- Variably tuned: 80Hz, 100Hz or 125Hz [$>50\text{Hz}; <250\text{Hz}$].
- Peak absorption at Low-frequency Average:
 - nominal pressure = $0.85\text{m}^2 / 80\text{Hz}$
 - 8 mBar = $0.86\text{m}^2 / 100\text{Hz}$
 - 14 mBar = $0.88\text{m}^2 / 125\text{Hz}$
- Package and Installation: individual and accessories included.
- Ideal for mid and large size halls.

ABSORPTION COEFFICIENT

■ αS	0.56	0.76	0.94	1.04	1.10	1.04	0.88	0.72	0.52	0.43	0.44	0.45	0.49	0.55	0.55	0.53	0.56	0.59	0.61	0.65	0.70	0.77	0.83	0.84	0.88	14 mBar PRESSURE
■ αS	0.60	0.79	0.97	1.08	1.05	0.94	0.84	0.63	0.47	0.43	0.46	0.44	0.49	0.56	0.55	0.52	0.57	0.58	0.60	0.60	0.67	0.74	0.79	0.81	0.86	8 mBar PRESSURE
■ αS	0.66	0.84	1.04	1.02	0.95	0.92	0.76	0.60	0.48	0.45	0.46	0.44	0.48	0.55	0.56	0.54	0.57	0.58	0.59	0.59	0.66	0.73	0.78	0.80	0.85	NORMAL PRESSURE

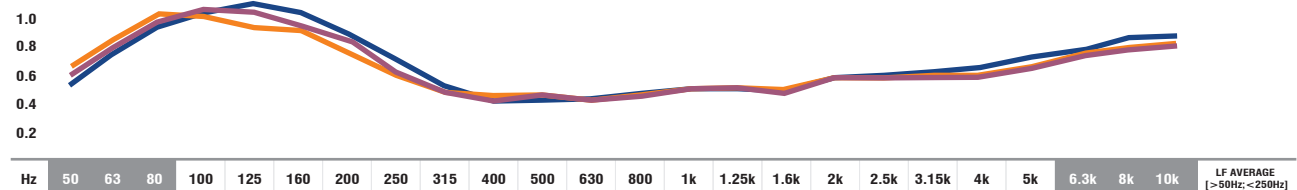

■ ■ ■ ABSORPTION COEFFICIENT: Values in accordance with the standards: EN 20654, ASTM C423 and EN 11654. ■ Values [$<100\text{Hz}$ and $>5\text{K}$] are Non Standard Values.

STANDARD FABRIC COLOURS



IMPORTANT NOTICES

- JOCAVI® accepts no responsibility for any printing errors. Specifications can be modified without prior notice, if technical or commercial reasons so require.
- RAL® is an international independent colour standard system partner for industry, trade, architecture and design. Should be consulted before placing any order.
- The colours shown on this catalogue are only a reference and an illustration of the products finishing. The colours shown are not binding because brightness, contrast and colour balance may vary due to the printing process.
- Colours may vary due to raw-material suppliers' changes and some differences may occur in tonal range.
- Wood and Fabric products are highly susceptible to change its appearance with humidity and temperature. Close attention must be paid to the storage conditions and the acclimatization before, during and after the installation.
- Typical Indoor Comfort Standards state a temperature range of 20°C - 27°C (68°F - 81°F), and a relative humidity of less than 60%. These would be considered as normal operational levels of JOCAVI® products' range.
- Despite all the standard sizes of all products, this model can be customised upon previous consultation. Sizes may vary slightly due to their production method and some inherent raw-materials characteristics.



BASSCORNER®

TUNED LF ABSORPTION PANEL

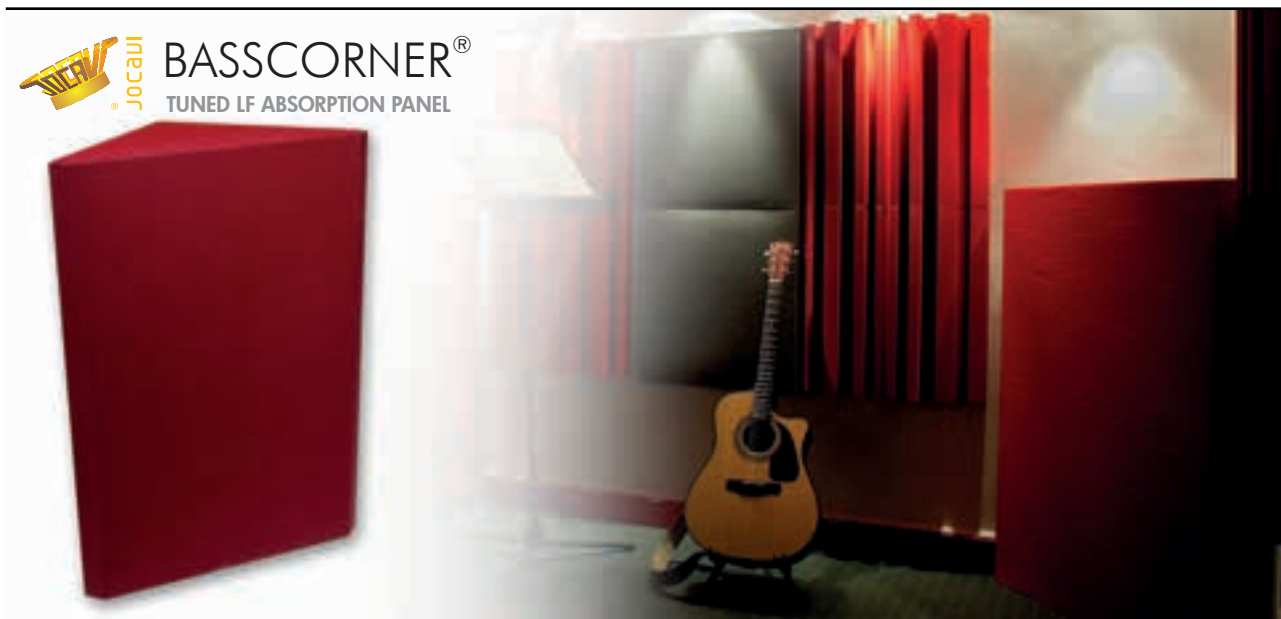

Image of 120x60cm model Ref.:BC0120 (on the left) and Ref.:BC0120 (ambient image).

DESCRIPTION

The control of low frequencies is essential in any music room, especially in the corners where long waves are generated, i.e., stationary low frequencies which are heard as a "boom", thus making low frequencies puffy and muddy and disjointed from the rest of the sound spectrum.

Applying JOCAVI's BASSCORNER® is imperative. This panel, which is extremely efficient at holding back excessive levels of low frequencies, is manufactured with an exclusive production membrane mounted on a tuned box, which makes this box highly efficient between 32 Hz and 280 Hz. The absorption panel BASSCORNER® reduces to a high degree the excessive energy of low frequencies. Its highest absorption coefficient stands at 100 Hz.

The trapezoidal shape of this panel makes it look discreet in the room, as it is installed in corners which are usually overlooked.

FEATURES

- Uses 60% of recycled materials.
- Tuned to 100Hz.
- LF Average absorption: **0.86/m²** [$>50\text{Hz}; <250\text{Hz}$].
- Fire-resistance: Euroclass B (similar to old M1).
- 100% recyclable.
- Installation: accessories included.

TECHNICAL DRAWINGS

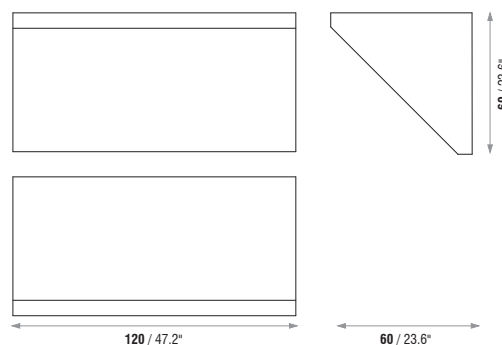

MODELS AND SIZES

MODELS	HEIGHT	WIDTH	DEPTH	WEIGHT
BC0120	120 cm (47.2 in)	60 cm (23.6 in)	60 cm (23.6 in)	28 Kg (61.73 lbs)

ABSORPTION COEFFICIENT

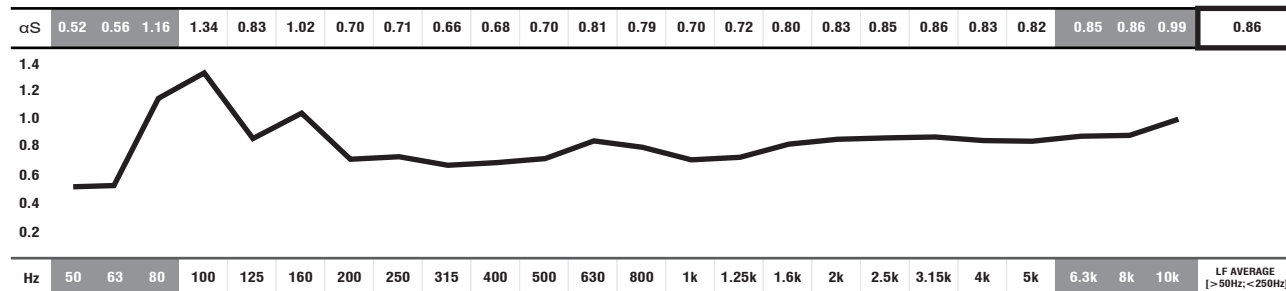

■ ABSORPTION COEFFICIENT: Values in accordance with the standards: EN 20654, ASTM C423 and EN 11654.

■ Values [$<100\text{Hz}$ and $>5\text{K}$] are Non Standard Values.

STANDARD FABRIC COLOURS



IMPORTANT NOTICES

- JOCAVI® accepts no responsibility for any printing errors. Specifications can be modified without prior notice, if technical or commercial reasons so require.
- RAL® is an international independent colour standard system partner for industry, trade, architecture and design. Should be consulted before placing any order.
- The colours shown on this catalogue are only a reference and an illustration of the products finishing. The colours shown are not binding because brightness, contrast and colour balance may vary due to the printing process.
- Colours may vary due to raw-material suppliers' changes and some differences may occur in tonal range.
- Wood and Fabric products are highly susceptible to change its appearance with humidity and temperature. Close attention must be paid to the storage conditions and the acclimatization before, during and after the installation.
- Typical Indoor Comfort Standards state a temperature range of 20°C - 27°C (68°F - 81°F), and a relative humidity of less than 60%. These would be considered as normal operational levels of JOCAVI® products' range.
- Despite all the standard sizes of all products, this model can be customised upon previous consultation. Sizes may vary slightly due to their production method and some inherent raw-materials characteristics.



BASSLAYER®

TUNED LF ABSORPTION PANEL



Image of 120x60cm model Ref.:BXL120 (on the left) and Ref.:BXL120 (ambient image).

DESCRIPTION

The control of low frequencies in audio rooms is always essential. The absorption of this energy is successful when the adequate solution is found.

We developed a product with a good technical performance, whose size does not hinder its application, and that is a solution to most types of rooms. This product is recommended for music audition rooms or music rehearsal rooms whose volumetric dimensions range between 32m³ and 220m³, obviously by using the number of products in proportion to the space in question.

The BASSLAYER® is a low-frequency absorbent panel. It has a hard membrane absorber inside a tuned box with four lateral holes and is tuned to 160 Hz.

Its shape is both appealing and discreet and it is a good option for walls or ceilings. It can also be mounted in pairs in the corners of rooms, turning into a highly efficient BASSCORNER®, also tuned to 80 Hz.

This product can be combined with the absorption panel MELLOWALLTRAP® to complement the absorption of medium frequencies.

FEATURES

- Uses 70% of recycled materials.
- Tuned to 160Hz.
- LF Average absorption: **0.59/m²** [$> 50\text{Hz}; < 250\text{Hz}$].
- Fire-resistance: Euroclass B (similar to old M1).
- 100% recyclable.
- Installation: accessories included.

TECHNICAL DRAWINGS

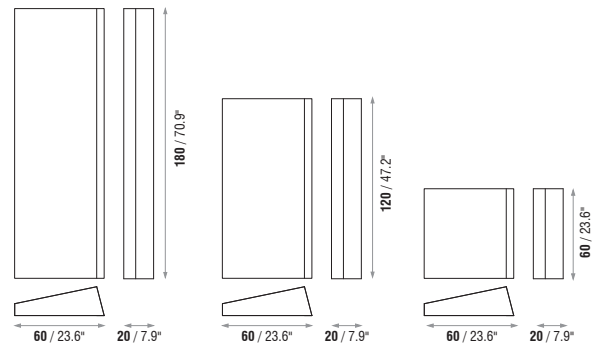

MODELS AND SIZES

MODELS	HEIGHT	WIDTH	DEPTH	WEIGHT
BXL180	180 cm (70.9 in)	60 cm (23.6 in)	20 cm (7.9 in)	14.2 Kg (31.31 lbs)
BXL120	120 cm (47.2 in)	60 cm (23.6 in)	20 cm (7.9 in)	9.9 Kg (21.83 lbs)
BXL060	60 cm (23.6 in)	60 cm (23.6 in)	20 cm (7.9 in)	5 Kg (11.02 lbs)

ABSORPTION COEFFICIENT

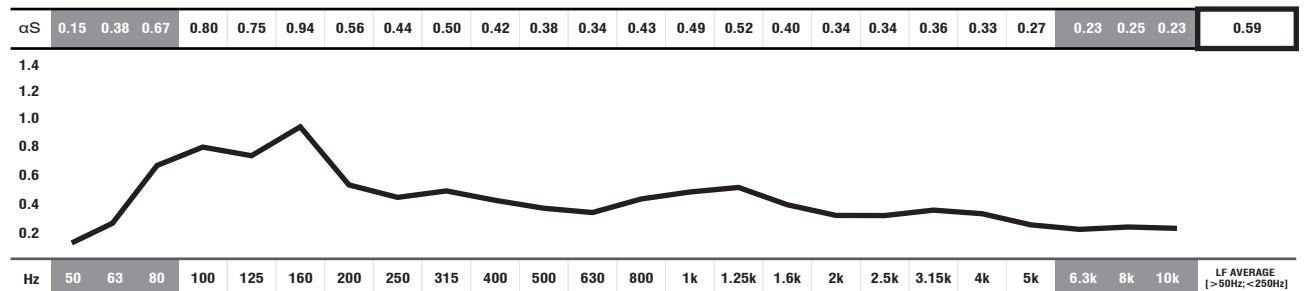

■ ABSORPTION COEFFICIENT: Values in accordance with the standards: EN 20654, ASTM C423 and EN 11654.

■ Values [$< 100\text{Hz}$ and $> 5\text{K}$] are Non Standard Values.

STANDARD FABRIC COLOURS

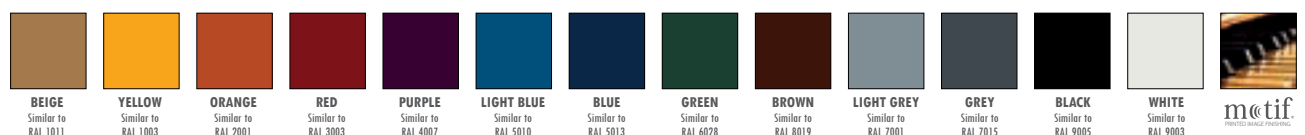

IMPORTANT NOTICES

- JOCAVI® accepts no responsibility for any printing errors. Specifications can be modified without prior notice, if technical or commercial reasons so require.
- RAL® is an international independent colour standard system partner for industry, trade, architecture and design. Should be consulted before placing any order.
- The colours shown on this catalogue are only a reference and an illustration of the products finishing. The colours shown are not binding because brightness, contrast and colour balance may vary due to the printing process.
- Colours may vary due to raw-material suppliers' changes and some differences may occur in total range.
- Wood and Fabric products are highly susceptible to change its appearance with humidity and temperature. Close attention must be paid to the storage conditions and the acclimatization before, during and after the installation.
- Typical Indoor Comfort Standards state a temperature range of 20°C - 27°C (68°F - 81°F), and a relative humidity of less than 60%. These would be considered as normal operational levels of JOCAVI® products' range.
- Despite all the standard sizes of all products, this model can be customised upon previous consultation. Sizes may vary slightly due to their production method and some inherent raw-materials characteristics.



LOWNOTE C[®]

TUNED LF ABSORPTION PANEL



LOWNOTE C[®] PETAL

LOWNOTE C[®] CLOVER

Image of 60x60cm models Ref.: LNC060p and LNC060.

DESCRIPTION

The LOWNOTE C[®] is a low frequency membrane absorbent panel. It is designed to fit into 90° corners, and its available tuning frequencies are 50Hz, 63Hz and 80Hz with a range coverage of absorption approximately 1/3 octave above and below the tuning frequency. It is developed to fine tune the modal distribution of small rooms such as studio control rooms and home theatres.

The principle used to develop LOWNOTE C[®] is the Helmholtz Resonator reasoning with a defined throat hole, through the use of a coloured engineered wood fibre board box with HIPS velvet finishing as the front membrane, thus creating the tuned resonant chamber.

This model can be combined with LOWNOTE W[®] in order to boost bass absorption. Together these panels extend the range of the frequencies absorption to the next harmonic frequency.

LOWNOTE C[®] can be easily and quickly suspended on any wall or ceiling 90° corner surface using its included accessories.

TECHNICAL DRAWINGS

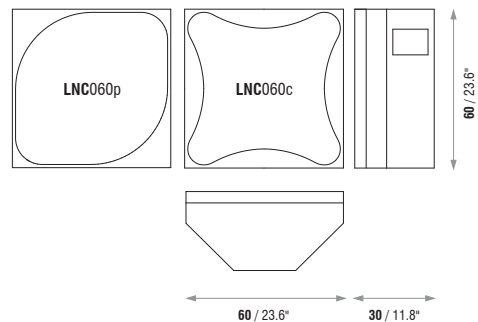

FEATURES

- Tuned at 50Hz, 63Hz or 80Hz upon request.
- LF Average absorption: **0.89/m²** [$>50\text{Hz}; <250\text{KHz}$].
- Box in engineered coloured wood fibre board.
- Front membrane made of HIPS with velvet finishing.
- Fire-resistance: Euroclass B-s2,d0 (similar to old M1) for box;
- VO - UL94 standards (similar to M2) for HIPS front.
- Installation: mounting accessories included.
- Can be used on walls.

MODELS AND SIZES

MODELS	HEIGHT	WIDTH	DEPTH	WEIGHT
LNC060c	60 cm (23.6 in)	60 cm (23.6 in)	30 cm (11.8 in)	7.2 Kg (15.87 lbs)
LNC060p	60 cm (23.6 in)	60 cm (23.6 in)	30 cm (11.8 in)	7.2 Kg (15.87 lbs)

ABSORPTION COEFFICIENT

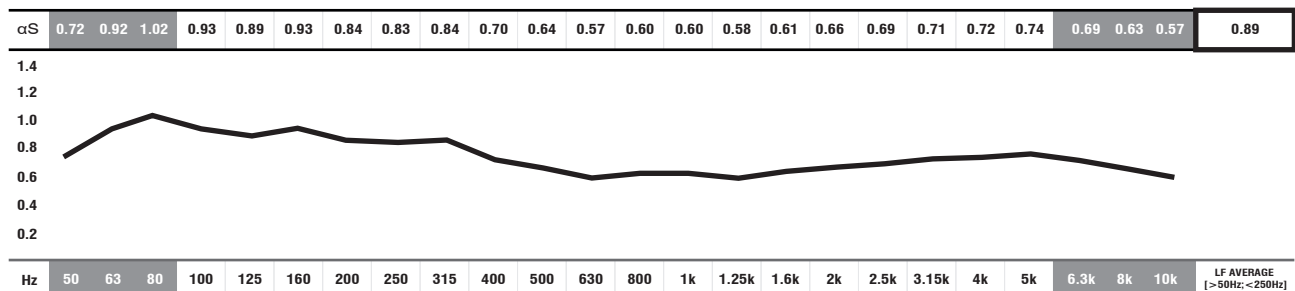

■ ABSORPTION COEFFICIENT: Values in accordance with the standards: EN 20654, ASTM C423 and EN 11654. Values [$<100\text{Hz}$ and $>5\text{K}$] are Non Standard Values. Presented values above are based on tests and measurements done with the LNC060c version tuned at 80Hz.

ENGINEERED COLOURED WOOD COLOURS (BOX)

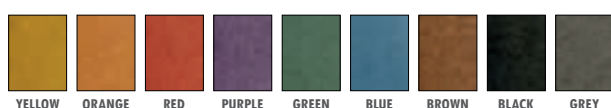

VELVETY COLOURS (FRONT)

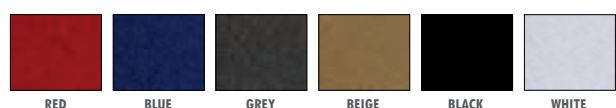

IMPORTANT NOTICES

- JOCAVI[®] accepts no responsibility for any printing errors. Specifications can be modified without prior notice, if technical or commercial reasons so require.
- The colours shown on this catalogue are only a reference and an illustration of the products finishing. The colours shown are not binding because brightness, contrast and colour balance may vary due to the printing process.
- Colours may vary due to raw-material suppliers' changes and some differences may occur in tonal range.
- Due to its natural origin, wood-based products will always present natural imperfections inherent to the organic nature. And for similar reasons, they will also present traces of old-age in the course of time.
- Wood and Fabric products are highly susceptible to change its appearance with humidity and temperature. Close attention must be paid to the storage conditions and the acclimatization before, during and after the installation.
- Typical Indoor Comfort Standards state a temperature range of 20°C - 27°C (68°F - 81°F), and a relative humidity of less than 60%. These would be considered as normal operational levels of JOCAVI[®] products' range.
- Despite all the standard sizes of all products, this model can be customised upon previous consultation. Sizes may vary slightly due to their production method and some inherent raw-materials characteristics.



LOWNOTE W[®]

TUNED LF ABSORPTION PANEL

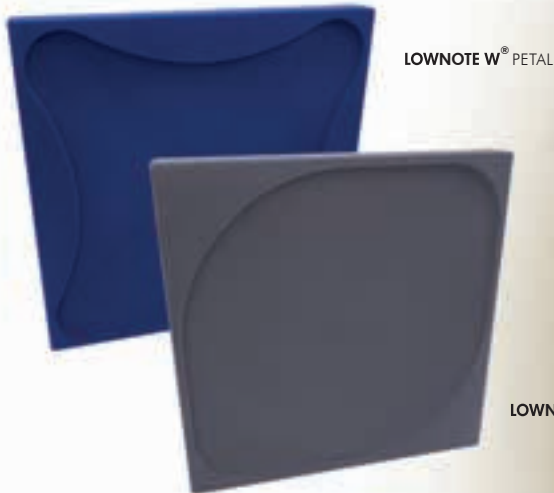

Image of 60x60cm models Ref.: LNW060p and LNW060c.

DESCRIPTION

The LOWNOTE W[®] acoustic panel is a broadband low-frequency sound absorber designed to balance the modal distribution on small rooms like studios, music listening rooms, and home-cinemas.

The principle used to develop the LOWNOTE W[®] is the Helmholtz Resonator reasoning, through the combination of an coloured engineered coloured wood fibre board box with an HIPS velvet finishing front membrane, which creates the tuned resonance chamber.

The dampening chamber system combined with the front concave shaped HIPS membrane is able to offer a large range of bass control over several octaves, while not contributing to add mid/high frequency absorption.

This model can be combined with LOWNOTE C[®] in order to extend the absorption and fine tune the low end of the sound spectrum. These combinations lengthen the lower frequencies absorption to a evenly absorption range.

LOWNOTE W[®] panel can be easily suspended on any wall or ceiling surface using the provided accessories. Panels can also be installed in a reinforced T-ceiling.

TECHNICAL DRAWINGS

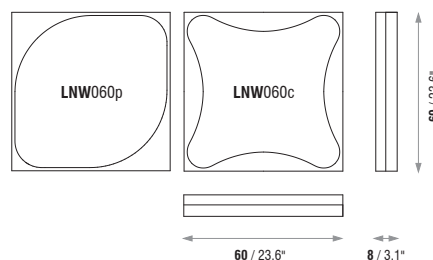

FEATURES

- Tuned at 160Hz.
- LF Average absorption: **0.81/m²** [$>50\text{Hz}; <250\text{KHz}$].
- Box in engineered coloured wood fibre board.
- Front membrane made of HIPS with velvet finishing.
- Fire-resistance: Euroclass B-s2,d0 (similar to old M1) for box; VO - UL94 standards (similar to M2) for HIPS front.
- Can be used on walls or ceilings.
- Installation: mounting accessories included.

MODELS AND SIZES

MODELS	HEIGHT	WIDTH	DEPTH	WEIGHT
LNW060c	60 cm (23.6 in)	60 cm (23.6 in)	8 cm (3.1 in)	5.2 Kg (11.46 lbs)
LNW060p	60 cm (23.6 in)	60 cm (23.6 in)	8 cm (3.1 in)	5.2 Kg (11.46 lbs)

ABSORPTION COEFFICIENT

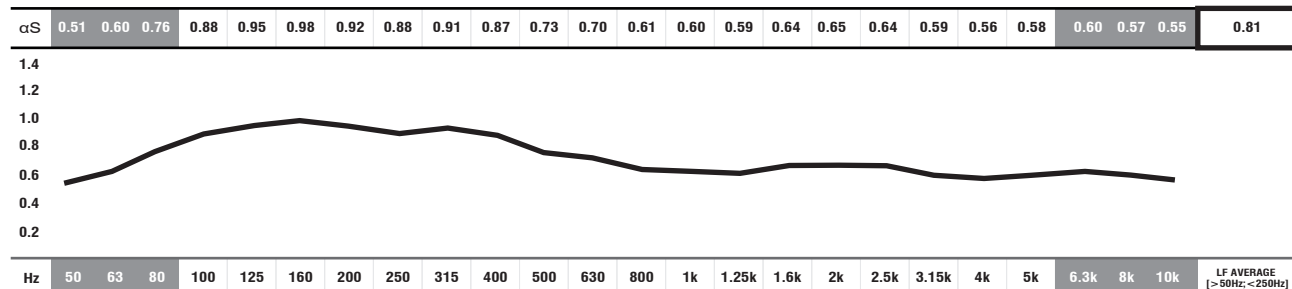

■ ABSORPTION COEFFICIENT: Values in accordance with the standards: EN 20654, ASTM C423 and EN 11654.

■ Values [$<100\text{Hz}$ and $>5\text{K}$] are Non Standard Values.

ENGINEERED COLOURED WOOD COLOURS (BOX)

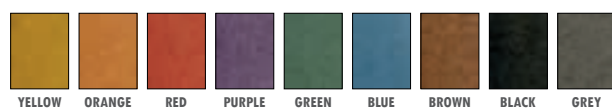

VELVETY COLOURS (FRONT)

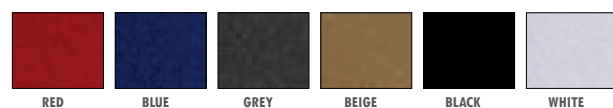

IMPORTANT NOTICES

- JOCAVI[®] accepts no responsibility for any printing errors. Specifications can be modified without prior notice, if technical or commercial reasons so require.
- The colours shown on this catalogue are only a reference and an illustration of the products finishing. The colours shown are not binding because brightness, contrast and colour balance may vary due to the printing process.
- Colours may vary due to raw-material suppliers' changes and some differences may occur in tonal range.
- Due to its natural origin, wood-based products will always present natural imperfections inherent to the organic nature. And for similar reasons, they will also present traces of old-age in the course of time.
- Wood and Fabric products are highly susceptible to change its appearance with humidity and temperature. Close attention must be paid to the storage conditions and the acclimatization before, during and after the installation.
- Typical Indoor Comfort Standards state a temperature range of 20°C - 27°C (68°F - 81°F), and a relative humidity of less than 60%. These would be considered as normal operational levels of JOCAVI[®] products' range.
- Despite all the standard sizes of all products, this model can be customised upon previous consultation. Sizes may vary slightly due to their production method and some inherent raw-materials characteristics.



HUMCUT BXA®

TUNED LF ABSORPTION PANEL

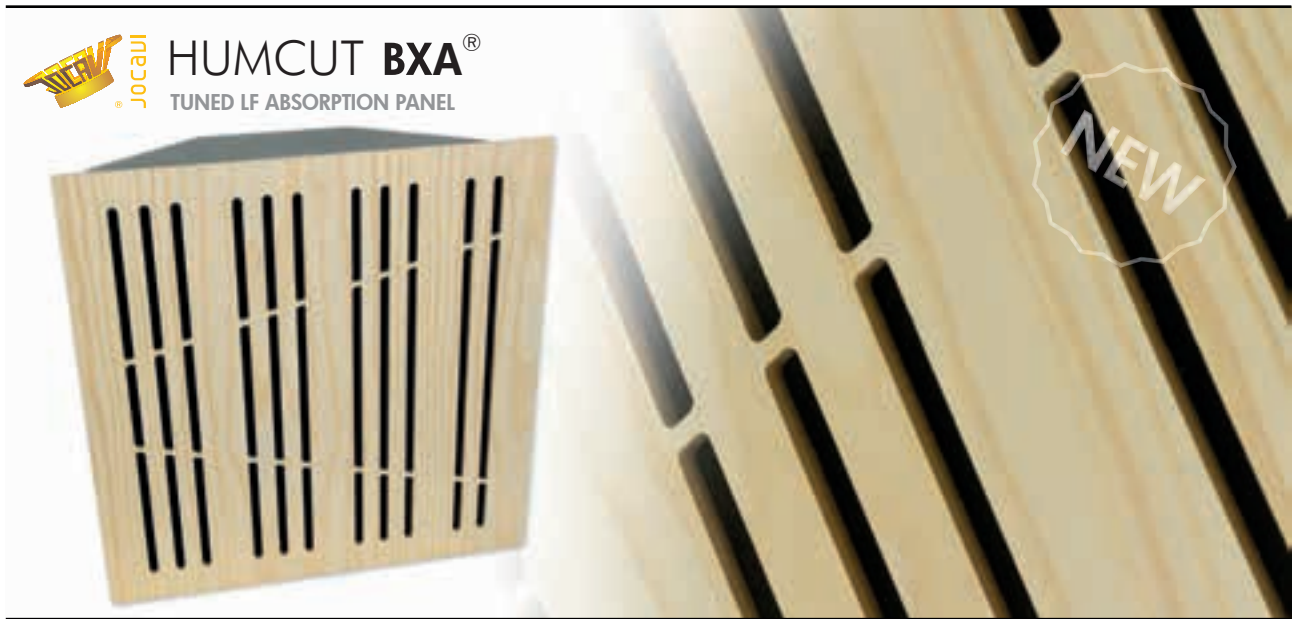

Image of 60x60cm model Ref.:BXA060 (on the left) and Ref.:BXA060 (ambient image).

DESCRIPTION

HUMcut BXA® is a low-frequency membrane absorption panel tuned to 63Hz that is meant to be used in 90° corners. The principle used in this model combines a HIPS box, which has an appropriately enhanced closed resonance chamber with mass and density components. The front plate is made of wood with several punching patterns and colors available.

In order to achieve the best results, this model can be used together with the HUMcut BXW®, tuned to 125Hz, used in flat surfaces. The combination of these two models, on the corners and walls, greatly broadens the low-frequencies absorption capacity as it extends the absorption range to the next harmonic frequency. This combination becomes one of the best offers for low-frequency absorbent acoustic treatment.

FEATURES

- Tuned to 63Hz.
- LF Average absorption: **0.86/m²** [$>50\text{Hz}; <250\text{Hz}$].
- Fire-resistance: Euroclass B-s2,d0 (similar to old M1).
- Made of recyclable materials.
- Front plate of Natural wood veneer.
- Application on ceiling and wall 90° corners.
- Installation: Aluminium optional mounting accessories sold separately.

TECHNICAL DRAWINGS

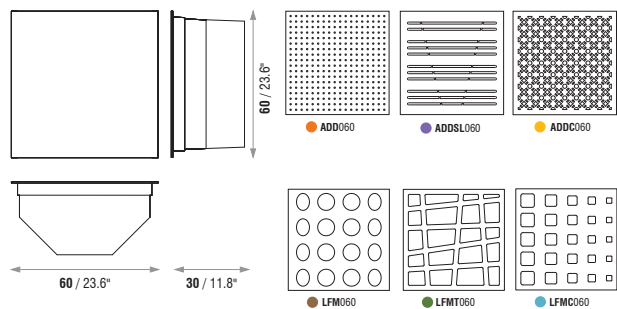

MODELS AND SIZES

MODELS	HEIGHT	WIDTH	DEPTH	WEIGHT
HCT060c	60 cm (23.6 in)	60 cm (23.6 in)	30 cm (11.8 in)	5.9 Kg (13.01 lbs)

● ADD060 ● ADDSL060 ● ADDC060 ● LFM060 ● LFMT060 ● LFMCO60

ABSORPTION COEFFICIENT

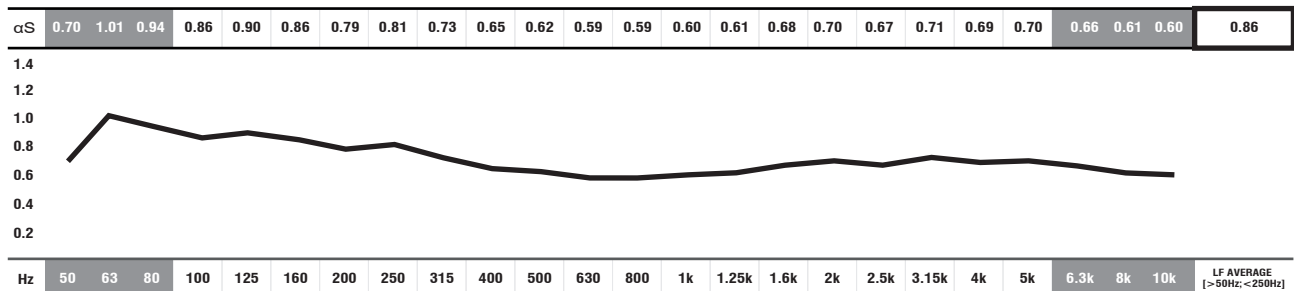

■ ABSORPTION COEFFICIENT: Values in accordance with the standards: EN 20654, ASTM C423 and EN 11654.

■ Values [$<100\text{Hz}$ and $>5\text{K}$] are Non Standard Values.

WOOD VENEER FINISHINGS



IMPORTANT NOTICES

- JOCAVI® accepts no responsibility for any printing errors. Specifications can be modified without prior notice, if technical or commercial reasons so require.
- The colours shown on this catalogue are only a reference and an illustration of the products finishing. The colours shown are not binding because brightness, contrast and colour balance may vary due to the printing process.
- Colours may vary due to raw-material suppliers' changes and some differences may occur in tonal range.
- Due to its natural origin, wood-based products will always present natural imperfections inherent to the organic nature. And for similar reasons, they will also present traces of old-age in the course of time.
- Wood and Fabric products are highly susceptible to change its appearance with humidity and temperature. Close attention must be paid to the storage conditions and the acclimatization before, during and after the installation.
- Typical Indoor Comfort Standards state a temperature range of 20°C - 27°C (68°F - 81°F), and a relative humidity of less than 60%. These would be considered as normal operational levels of JOCAVI® products' range.
- Despite all the standard sizes of all products, this model can be customised upon previous consultation. Sizes may vary slightly due to their production method and some inherent raw-materials characteristics.



HUMCUT BXW[®]

TUNED LF ABSORPTION PANEL



NEW

Image of 60x60cm model Ref.:BXW060 (on the left) and Ref.:BXW060 (ambient image).

DESCRIPTION

HUMcut BXW[®] is a low-frequency membrane absorption panel tuned to 125Hz and is meant to be used in flat surfaces like walls and ceilings. The principle used in this model combines a HIPS box, which has an appropriately closed resonance box with mass and density components. The front plate is made of wood with several perforated patterns and colors are available.

In order to archive the best results, this model can be used together with the HUMcut BXA[®], tuned to 63Hz, used in 90° corners. The combination of these two models, placed on the corners and walls, greatly broaden the low-frequencies absorption capacity as it extends the absorption range to the previous harmonic frequency. This combination becomes one of the most efficient low-frequency absorbent acoustic treatment solutions.

FEATURES

- Tuned to 125Hz.
- LF Average absorption: **0.83/m²** [$>50\text{Hz}; <250\text{Hz}$].
- Fire-resistance: Euroclass B-s2,d0 (similar to old M1).
- Made of recyclable materials.
- Front plate of natural wood veneer.
- Application on ceiling and walls.
- Installation: Aluminium optional mounting accessories sold separately.

TECHNICAL DRAWINGS

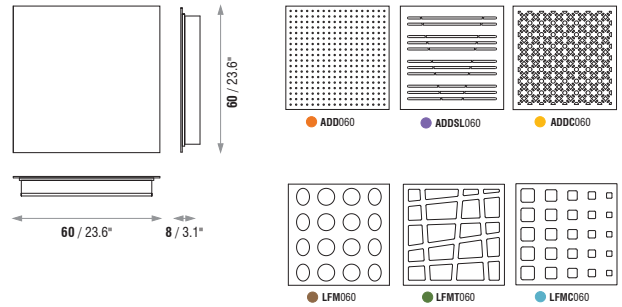

MODELS AND SIZES

MODELS	HEIGHT	WIDTH	DEPTH	WEIGHT
HCT060w	60 cm (23.6 in)	60 cm (23.6 in)	8 cm (3.1 in)	4.2 Kg (9.26 lbs)

● ADD060 ● ADDSL060 ● ADDC060 ● LFM060 ● LFMT060 ● LFMCO60

ABSORPTION COEFFICIENT

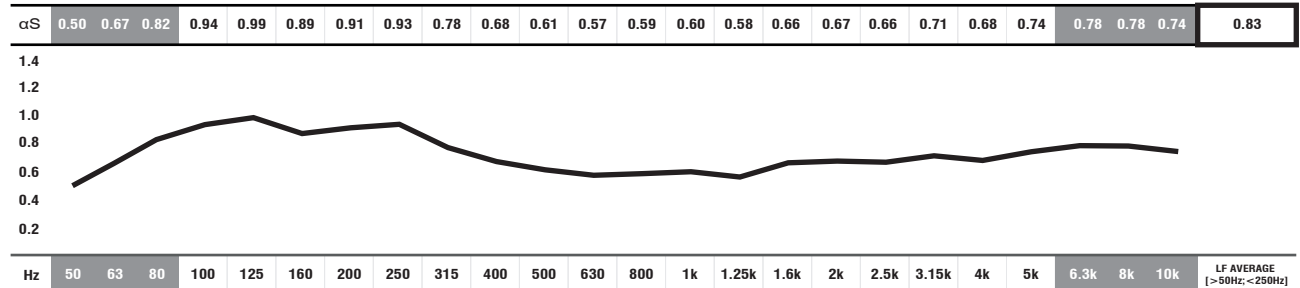

■ ABSORPTION COEFFICIENT: Values in accordance with the standards: EN 20654, ASTM C423 and EN 11654. ■ Values [$<100\text{Hz}$ and $>5\text{K}$] are Non Standard Values.

WOOD VENEER FINISHINGS



IMPORTANT NOTICES

- JOCABI[®] accepts no responsibility for any printing errors. Specifications can be modified without prior notice, if technical or commercial reasons so require.
- The colours shown on this catalogue are only a reference and an illustration of the products finishing. The colours shown are not binding because brightness, contrast and colour balance may vary due to the printing process.
- Colours may vary due to raw-material suppliers' changes and some differences may occur in tonal range.
- Due to its natural origin, wood-based products will always present natural imperfections inherent to the organic nature. And for similar reasons, they will also present traces of old-age in the course of time.
- Wood and Fabric products are highly susceptible to change its appearance with humidity and temperature. Close attention must be paid to the storage conditions and the acclimatization before, during and after the installation.
- Typical Indoor Comfort Standards state a temperature range of 20°C - 27°C (68°F - 81°F), and a relative humidity of less than 60%. These would be considered as normal operational levels of JOCABI[®] products' range.
- Despite all the standard sizes of all products, this model can be customised upon previous consultation. Sizes may vary slightly due to their production method and some inherent raw-materials characteristics.



ROUNDBASSCORNER®

TUNED LF ABSORPTION PANEL



Image of 120x50cm model Ref.:RCO120 (on the left) and Ref.:RCO120 (ambient image).

DESCRIPTION

It is of paramount importance to control the low range of the sound spectrum in any music room. In corners, for example, long waves are usually generated, as well as stationary low frequencies, which are heard as a "boom", thus making them slack, loose and disjointed from the rest of the spectrum range.

This panel, which is extremely efficient at holding back excessive levels of low frequencies, is manufactured with an exclusive production membrane applied over a tuned box.

The ROUNDBASSCORNER® panel provides a good reduction of energy between 40 Hz and 400 Hz. Its highest level of reduction is at 125 Hz. This product reduces or eliminates unwanted low resonances.

Because of their trapezoidal shape, these panels look discreet in the room, since they are installed in corners which are usually overlooked.

FEATURES

- Uses 60% of recycled materials.
- Tuned to 125Hz.
- LF Average absorption: **0.92/m²** [$>50\text{Hz}; <250\text{Hz}$].
- Fire-resistance: Euroclass B (similar to old M1).
- 100% recyclable.
- Installation: accessories included.

TECHNICAL DRAWINGS

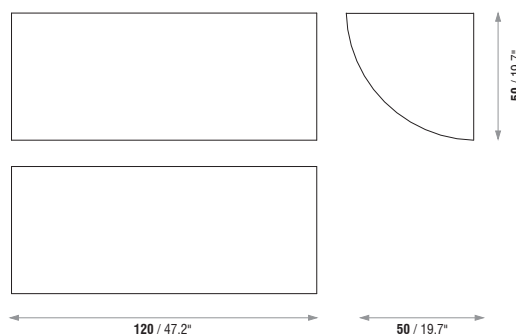

MODELS AND SIZES

MODELS	HEIGHT	WIDTH	DEPTH	WEIGHT
RCO120	120 cm (47.2 in)	50 cm (19.7 in)	50 cm (19.7 in)	22 Kg (48.50 lbs)

ABSORPTION COEFFICIENT

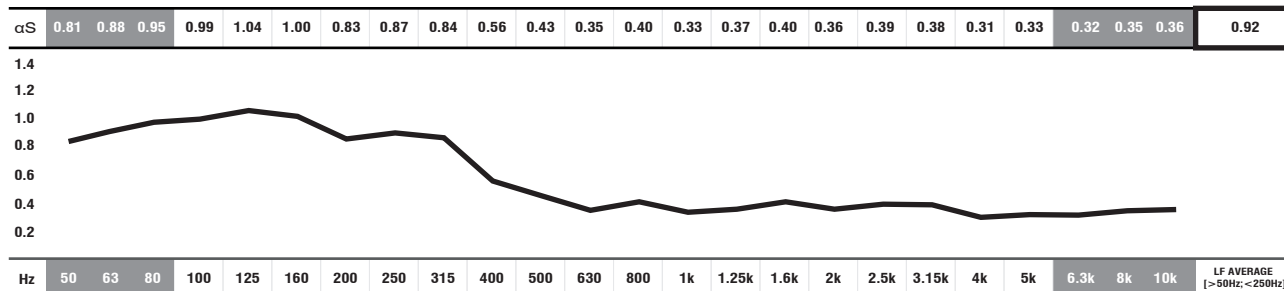

■ ABSORPTION COEFFICIENT: Values in accordance with the standards: EN 20654, ASTM C423 and EN 11654.

■ Values [$<100\text{Hz}$ and $>5\text{K}$] are Non Standard Values.

STANDARD FABRIC COLOURS



IMPORTANT NOTICES

- JOCAVI® accepts no responsibility for any printing errors. Specifications can be modified without prior notice, if technical or commercial reasons so require.
- RAL® is an international independent colour standard system partner for industry, trade, architecture and design. Should be consulted before placing any order.
- The colours shown on this catalogue are only a reference and an illustration of the products finishing. The colours shown are not binding because brightness, contrast and colour balance may vary due to the printing process.
- Colours may vary due to raw-material suppliers' changes and some differences may occur in tonal range.
- Wood and Fabric products are highly susceptible to change its appearance with humidity and temperature. Close attention must be paid to the storage conditions and the acclimatization before, during and after the installation.
- Typical Indoor Comfort Standards state a temperature range of 20°C - 27°C (68°F - 81°F), and a relative humidity of less than 60%. These would be considered as normal operational levels of JOCAVI® products' range.
- Despite all the standard sizes of all products, this model can be customised upon previous consultation. Sizes may vary slightly due to their production method and some inherent raw-materials characteristics.



STAITD TREAT BXA®

TUNED LF ABSORPTION PANEL

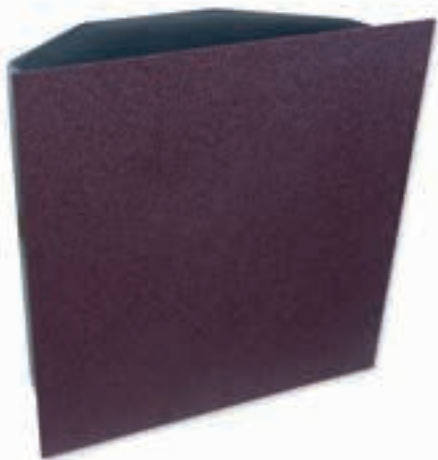

Image of 60x60cm model Ref.:BXA060 (on the left) and Ref.:BXA060 (ambient image).

DESCRIPTION

The STAITD TREAT BXA® is a low-frequency absorption panel. It is tuned to 63 Hz and is meant to be placed in 90° corners. The principle used to develop the STAITD TREAT BXA® is exclusive to JOCAVI®. It combines an HIPS box, which has two appropriately enhanced closed resonance chambers inside, with mass and density components. These components have been specifically developed for this model.

Therefore, because of its careful development, this panel has become one of the best offers in the market for low-frequency absorbent materials.

In order to boost bass absorption, we recommend that this panel is used together with the STAITD TREAT BXW®, as the latter functions close to the harmonics of this model.

It can also be incorporated a high quality performance speaker. Its designed to aesthetically conceal acoustic treatment with speakers providing a good sound intelligibility, besides making technology imperceptible to eyesight. This system was essentially planned for 7.1 and 5.1 home-theatres surround systems, but it is also advisable for conference rooms, restaurants and bars, public spaces and for background music or speech purposes.

FEATURES

- Plate of pressed mineral granulate.
- Tuned to 63Hz.
- LF Average absorption: **0.86/m²** [$>50\text{Hz}; <250\text{Hz}$].
- Fire-resistance: Euroclass A2-s2,d0 (similar to old M1).
- Made of recyclable materials.
- Application on ceiling and wall corners
- Installation: Mounting Aluminium Bars NOT included.

TECHNICAL DRAWINGS

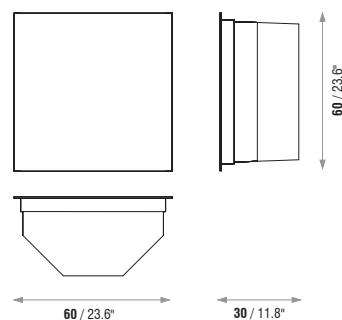

MODELS AND SIZES

MODELS	HEIGHT	WIDTH	DEPTH	WEIGHT
BXA060	60 cm (23.6 in)	60 cm (23.6 in)	30 cm (11.8 in)	5.9 Kg (13.01 lbs)
BXA060/SP 40	60 cm (23.6 in)	60 cm (23.6 in)	30 cm (11.8 in)	11.1 Kg (24.47 lbs)

ABSORPTION COEFFICIENT

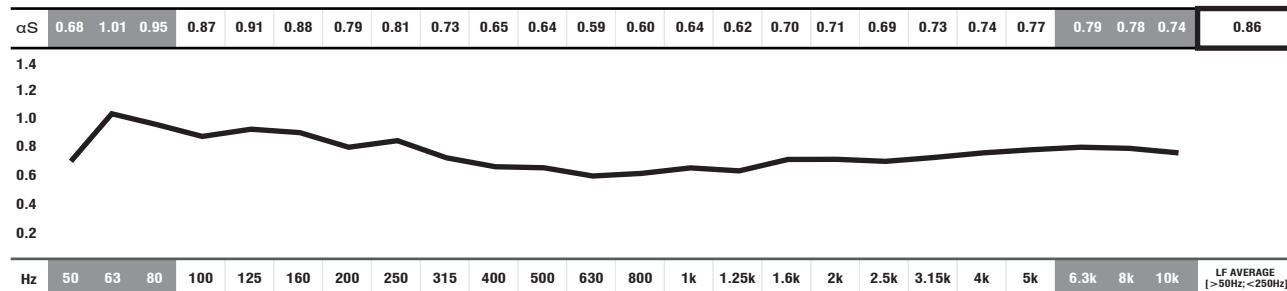

■ ABSORPTION COEFFICIENT: Values in accordance with the standards: EN 20654, ASTM C423 and EN 11654.

■ Values [$<100\text{Hz}$ and $>5\text{K}$] are Non Standard Values.

STANDARD MINERAL GRANULATED COLOURS



BLACK



MAROON



BROWN



RED



BLUE



GREY

IMPORTANT NOTICES

- JOCAVI® accepts no responsibility for any printing errors. Specifications can be modified without prior notice, if technical or commercial reasons so require.
- RAL® is an international independent colour standard system partner for industry, trade, architecture and design. Should be consulted before placing any order.
- The colours shown on this catalogue are only a reference and an illustration of the products finishing. The colours shown are not binding because brightness, contrast and colour balance may vary due to the printing process.
- Colours may vary due to raw-material suppliers' changes and some differences may occur in tonal range.
- Typical Indoor Comfort Standards state a temperature range of 20°C - 27°C (68°F - 81°F), and a relative humidity of less than 60%. These would be considered as normal operational levels of JOCAVI® products' range.
- Sizes may vary slightly due to their production method and some inherent raw-materials characteristics.



STAITREAT BXW[®]

TUNED LF ABSORPTION PANEL



Image of 60x60cm model Ref.:BXW060 (on the left) and Ref.:BXW060 (ambient image).

DESCRIPTION

The STAITREAT BXW[®] is a low-frequency absorption panel. It is tuned to 125 Hz and it can be installed on walls or T-type ceilings. When tuned to 125 Hz, it works in the first harmonic of the STAITREAT BXA[®], thus exponentially boosting the absorption of basses when both panels are used together.

This tuned panel uses an open resonance chamber, which is combined with a membrane that was developed and calibrated to enhance its performance.

The visible outer plate is made of a porous and permeable mineral granulate which is highly absorbent in the medium and high frequencies, thus further widening the absorption range of this panel.

TECHNICAL DRAWINGS

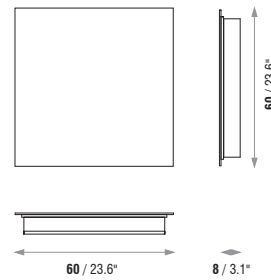

FEATURES

- Plate of pressed mineral granulate.
- Tuned to 125Hz.
- LF Average absorption: **0.83/m²** [$>50\text{Hz}; <250\text{Hz}$].
- Fire-resistance: Euroclass A2-s2,d0 (similar to old M1).
- Made of recyclable materials.
- Application on ceilings and walls.
- Installation: Mounting Aluminium Bars NOT included.

MODELS AND SIZES

MODELS	HEIGHT	WIDTH	DEPTH	WEIGHT
BXW060	60 cm (23.6 in)	60 cm (23.6 in)	8 cm (3.1 in)	4.2 Kg (9.26 lbs)

ABSORPTION COEFFICIENT

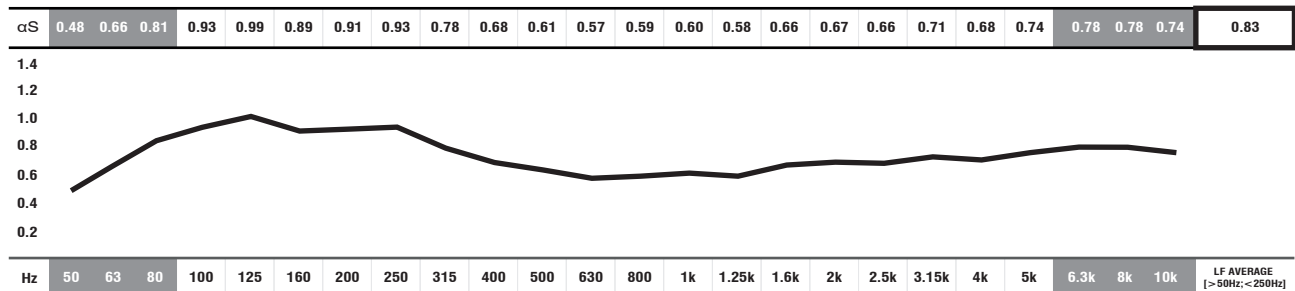

■ ABSORPTION COEFFICIENT: Values in accordance with the standards: EN 20654, ASTM C423 and EN 11654.

■ Values [$<100\text{Hz}$ and $>5\text{K}$] are Non Standard Values.

STANDARD MINERAL GRANULATED COLOURS

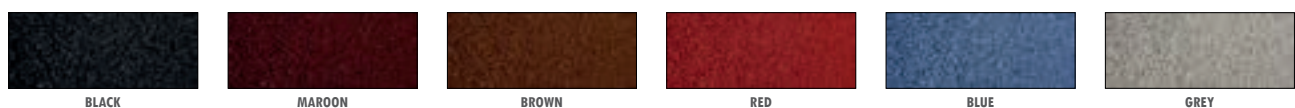

IMPORTANT NOTICES

- JOCAVI[®] accepts no responsibility for any printing errors. Specifications can be modified without prior notice, if technical or commercial reasons so require.
- RAL[®] is an international independent colour standard system partner for industry, trade, architecture and design. Should be consulted before placing any order.
- The colours shown on this catalogue are only a reference and an illustration of the products finishing. The colours shown are not binding because brightness, contrast and colour balance may vary due to the printing process.
- Colours may vary due to raw-material suppliers' changes and some differences may occur in tonal range.
- Typical Indoor Comfort Standards state a temperature range of 20°C - 27°C (68°F - 81°F), and a relative humidity of less than 60%. These would be considered as normal operational levels of JOCAVI[®] products' range.
- Sizes may vary slightly due to their production method and some inherent raw-materials characteristics.



TONAL® C

TUNED LF ABSORPTION PANEL



Image of 60x60cm model Ref.:TNL060c (on the left) and Ref.:TNL060c (ambient image).

DESCRIPTION

The TONAL Corner® is a low frequency membrane absorbent panel designed to fit into 90° corners. Tuned to 50Hz, 63Hz or 80Hz, it has a range of absorption coverage of approximately 1/3 of octave above and below the tuning frequency. It is developed to fine tune the modal distribution of small rooms such as studio control rooms and home theatres.

The principle used to develop TONAL Corner® is the Helmholtz Resonator reasoning with a defined neck length, using of a coloured engineered wood fiber board box with HIPS fabric finishing as the front membrane, thus creating the tuned resonant chamber.

This model can be combined with TONAL Wall®, in order to improve bass absorption. TONAL Wall® is a model designed for flat surfaces like walls and ceilings. Together these panels broaden the range of the absorbed frequencies to the next harmonic frequency. This combination is one of the best ways to treat low-frequency problems in small and medium-sized rooms.

TECHNICAL DRAWINGS

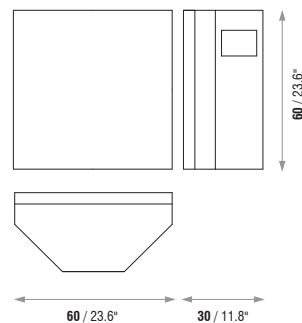

FEATURES

- Tuned to 50Hz, 63Hz and 80Hz.
- LF Average absorption [$>50\text{Hz}; <250\text{Hz}$]:
80 Hz = $0.88/\text{m}^2$ - 63 Hz = $0.89/\text{m}^2$ - 50 Hz = $0.86/\text{m}^2$
- Box made of Coloured Engineered Wood Fiber Board.
- Front membrane made of HIPS with fabric covered finishing.
- Fire-resistance: Euroclass B-s2,d0 (similar to old M1).
- Application on ceiling and wall corners.
- Package: 2 units
- Installation: accessories included.

MODELS AND SIZES

MODELS	HEIGHT	WIDTH	DEPTH	WEIGHT
TNL060c	60 cm (23.6 in)	60 cm (23.6 in)	30 cm (11.8 in)	5.9 Kg (13.01 lbs)

ABSORPTION COEFFICIENT

■	α_S	0.70	0.92	1.02	0.93	0.89	0.93	0.84	0.83	0.85	0.70	0.65	0.59	0.60	0.61	0.63	0.67	0.65	0.64	0.71	0.70	0.74	0.69	0.64	0.57	0.88	80 Hz
■	α_S	0.80	0.97	0.94	0.88	0.93	0.90	0.85	0.81	0.84	0.70	0.66	0.60	0.61	0.62	0.65	0.67	0.66	0.65	0.72	0.71	0.74	0.70	0.64	0.58	0.89	63 Hz
■	α_S	0.90	0.90	0.80	0.90	0.80	0.90	0.90	0.80	0.84	0.70	0.66	0.59	0.60	0.60	0.64	0.66	0.66	0.64	0.71	0.70	0.74	0.69	0.64	0.57	0.86	50 Hz

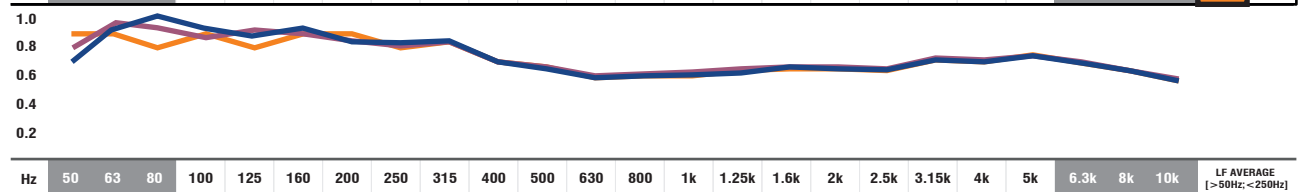

■ ■ ■ ABSORPTION COEFFICIENT: Values in accordance with the standards: EN 20654, ASTM C423 and EN 11654. ■ Values [$<100\text{Hz}$ and $>5\text{K}$] are Non Standard Values.

ENGINEERED COLOURED WOOD COLOURS (BOX)

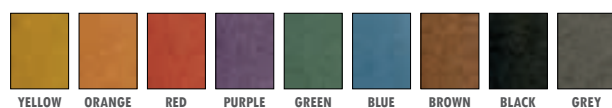

STANDARD FABRIC COLOURS

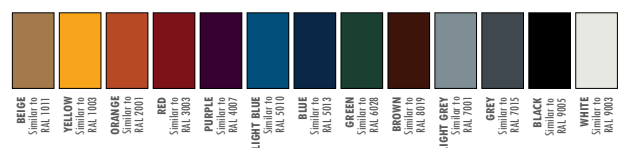

IMPORTANT NOTICES

- JOCAVI® accepts no responsibility for any printing errors. Specifications can be modified without prior notice, if technical or commercial reasons so require.
- The colours shown on this catalogue are only a reference and an illustration of the products finishing. The colours shown are not binding because brightness, contrast and colour balance may vary due to the printing process.
- Colours may vary due to raw-material suppliers' changes and some differences may occur in tonal range.
- Due to its natural origin, wood-based products will always present natural imperfections inherent to the organic nature. And for similar reasons, they will also present traces of old-age in the course of time.
- Wood and Fabric products are highly susceptible to change its appearance with humidity and temperature. Close attention must be paid to the storage conditions and the acclimatization before, during and after the installation.
- Typical Indoor Comfort Standards state a temperature range of 20°C - 27°C (68°F - 81°F), and a relative humidity of less than 60%. These would be considered as normal operational levels of JOCAVI® products' range.
- Despite all the standard sizes of all products, this model can be customised upon previous consultation. Sizes may vary slightly due to their production method and some inherent raw-materials characteristics.



TONAL® W

TUNED LF ABSORPTION PANEL



Image of 60x60cm model Ref.:TNL060w (on the left) and Ref.:TNL060w (ambient image).

DESCRIPTION

The TONAL Wall® is a low frequency membrane absorbent panel tuned at 125 Hz and designed to be used in flat surfaces like walls and ceilings. It is developed to fine tune the modal distribution of small rooms such as studio control rooms and home theatres.

This model can be combined with TONAL Corner®, in order to enhance bass absorption. TONAL Corner® is a low frequency membrane absorbent panel designed to fit 90° corners, and its available tuning frequencies are 50Hz, 63Hz and 80Hz.

Together these panels extend the range of the absorbed frequencies to the next harmonic frequency. This combination is one of the best ways to treat low-frequency problems in small and medium-sized rooms.

FEATURES

- Tuned to 125Hz.
- LF Average absorption: **0.82/m²** [$>50\text{Hz}; <250\text{Hz}$].
- Box made of Coloured Engineered Wood Fiber Board.
- Front membrane made of HIPS with fabric covered finishing.
- Fire-resistance: Euroclass B-s2,d0 (similar to old M1).
- Application on ceiling and wall corners.
- Installation: accessories included.

TECHNICAL DRAWINGS

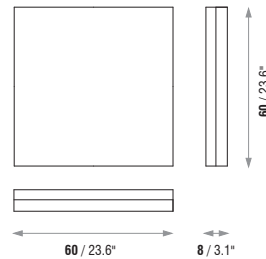

MODELS AND SIZES

MODELS	HEIGHT	WIDTH	DEPTH	WEIGHT
TNL060w	60 cm (23.6 in)	60 cm (23.6 in)	8 cm (3.1 in)	4.2 Kg (9.26 lbs)

ABSORPTION COEFFICIENT

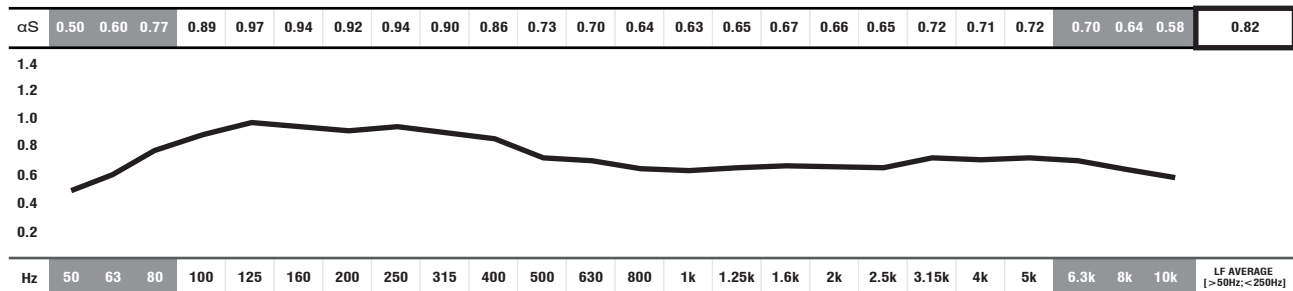

■ ABSORPTION COEFFICIENT: Values in accordance with the standards: EN 20654, ASTM C423 and EN 11654.

■ Values [$<100\text{Hz}$ and $>5\text{K}$] are Non Standard Values.

ENGINEERED COLOURED WOOD COLOURS (BOX)

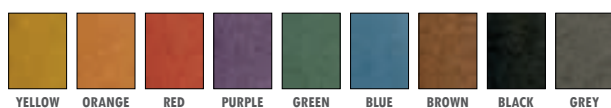

STANDARD FABRIC COLOURS

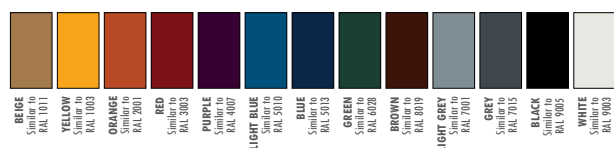

IMPORTANT NOTICES

- JOCAVI® accepts no responsibility for any printing errors. Specifications can be modified without prior notice, if technical or commercial reasons so require.
- The colours shown on this catalogue are only a reference and an illustration of the products finishing. The colours shown are not binding because brightness, contrast and colour balance may vary due to the printing process.
- Colours may vary due to raw-material suppliers' changes and some differences may occur in tonal range.
- Due to its natural origin, wood-based products will always present natural imperfections inherent to the organic nature. And for similar reasons, they will also present traces of old-age in the course of time.
- Wood and Fabric products are highly susceptible to change its appearance with humidity and temperature. Close attention must be paid to the storage conditions and the acclimatization before, during and after the installation.
- Typical Indoor Comfort Standards state a temperature range of 20°C - 27°C (68°F - 81°F), and a relative humidity of less than 60%. These would be considered as normal operational levels of JOCAVI® products' range.
- Despite all the standard sizes of all products, this model can be customised upon previous consultation. Sizes may vary slightly due to their production method and some inherent raw-materials characteristics.



TUBABSORBER® / SY

TUNED LF ABSORPTION PANEL

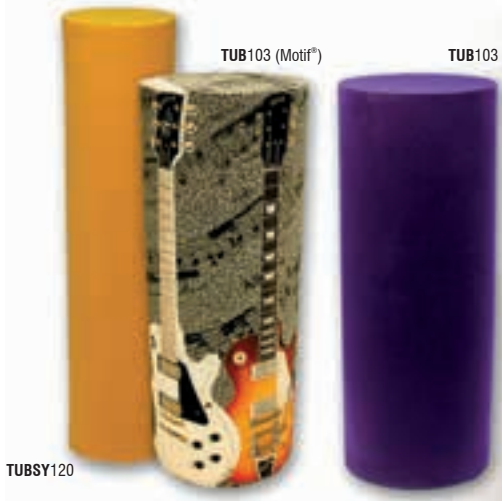

Image of 103x40cm models Ref.:TUB103 (on the left with and without MOTIF® finishing), 120x30cm model Ref.:TUBSY120 and Ref.:TUB103 applied (ambient image).

DESCRIPTION

The Tubabsorber® and Tubabsorber® SY are the most important absorbing elements of medium/low frequencies in our catalog. They were created to take most advantage in areas of high acoustic pressure that is normally generated in the corners of rooms. Due to the way they work each model can be mounted on the floor or suspended on ceilings. When they are installed on the floor they are easy to assemble and to adjust in order to optimise the results. Due to its smallest resonance chamber the Tubabsorber®SY is tuned to a higher frequency, 250Hz, while the Tubabsorber® is tuned slightly below 200Hz. The materials used in its manufacture are very light and highly efficient what gives to these models versatility, efficiency and ease of assembly.

FEATURES

- Uses 60% of recycled materials.
- Tuned to 200Hz (TUB103) and 250Hz (TUBSY120).
- LF Average absorption: **0.69/m²** (Tubabsorber®) and **0.45/m²** (Tubabsorber®SY) [$>50\text{Hz}; <250\text{Hz}$].
- Fire-resistance: Euroclass B (similar to old M1).
- 100% recyclable.
- Installation: accessories included

TECHNICAL DRAWINGS

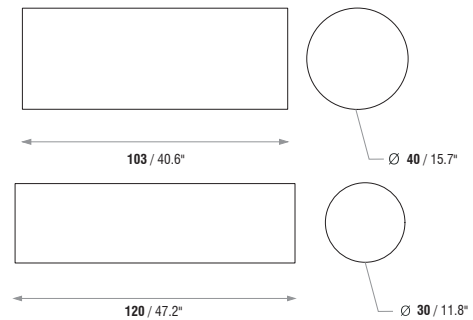

MODELS AND SIZES

MODELS	HEIGHT	DIAMETER	WEIGHT
TUB103	103 cm (40.6 in)	Ø 40 cm (15.7 in)	8.2 Kg (18.08 lbs)
TUBSY120	120 cm (47.2 in)	Ø 30 cm (11.8 in)	7 Kg (15.43 lbs)

ABSORPTION COEFFICIENT

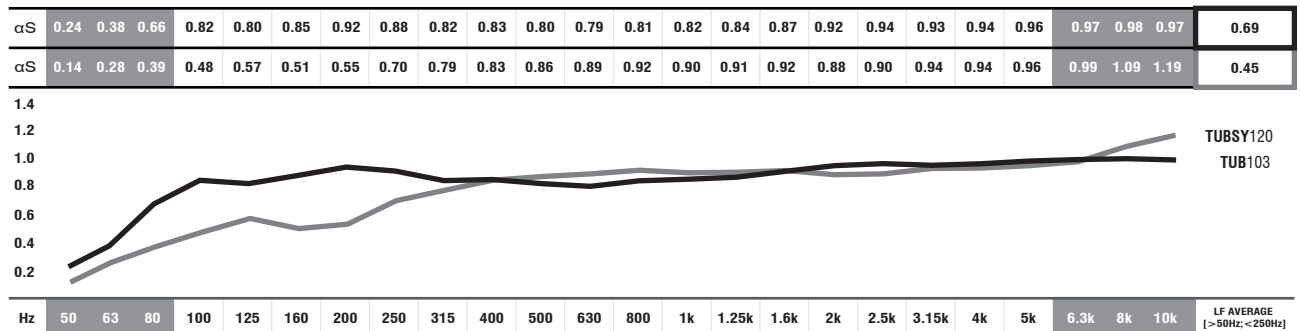

■ ABSORPTION COEFFICIENT: Values in accordance with the standards: EN 20654, ASTM C423 and EN 11654.

■ Values [$<100\text{Hz}$ and $>5\text{K}$] are Non Standard Values.

STANDARD FABRIC COLOURS



IMPORTANT NOTICES

- JOCAVI® accepts no responsibility for any printing errors. Specifications can be modified without prior notice, if technical or commercial reasons so require.
- RAL® is an international independent colour standard system partner for industry, trade, architecture and design. Should be consulted before placing any order.
- The colours shown on this catalogue are only a reference and an illustration of the products finishing. The colours shown are not binding because brightness, contrast and colour balance may vary due to the printing process.
- Colours may vary due to raw-material suppliers' changes and some differences may occur in tonal range.
- Wood and Fabric products are highly susceptible to change its appearance with humidity and temperature. Close attention must be paid to the storage conditions and the acclimatization before, during and after the installation.
- Typical Indoor Comfort Standards state a temperature range of 20°C - 27°C (68°F - 81°F), and a relative humidity of less than 60%. These would be considered as normal operational levels of JOCAVI® products' range.
- Despite all the standard sizes of all products, this model can be customised upon previous consultation. Sizes may vary slightly due to their production method and some inherent raw-materials characteristics.



WALLTRAP®

TUNED LF ABSORPTION PANEL



Image of 60x60cm model Ref.:WAL060 (on the left) and Ref.:WAL060 (ambient image).

DESCRIPTION

Music audition rooms, studios, practice rooms, etc., all need a surface that is efficient at absorbing low frequencies. The WALLTRAP® is a product that absorbs low frequencies. It is meant to be mounted on walls and ceilings.

This product has been especially designed to be a main element in the construction of rooms, since it is embedded in the walls.

This panel is built in a box tuned to 80 Hz and its subsequent harmonic of 160 Hz, its membrane is manufactured by us.

The WALLTRAP® is a very easy-to-install high performance panel. It is meant to be mounted on walls or ceilings. It was designed to absorb the incident sound on the back, front or side walls, thus reducing the low energy that is present in excessive levels at the point of hearing. Therefore, it reduces unwanted resonances and helps to accommodate and improve sound perception within the low range of the sound.

FEATURES

- Uses 60% of recycled materials.
- Tuned to 80Hz.
- LF Average absorption: **0.82/m²** [$>50\text{Hz}; <250\text{Hz}$].
- Fire-resistance: Euroclass B (similar to old M1).
- 100% recyclable.
- Installation: accessories included.

TECHNICAL DRAWINGS

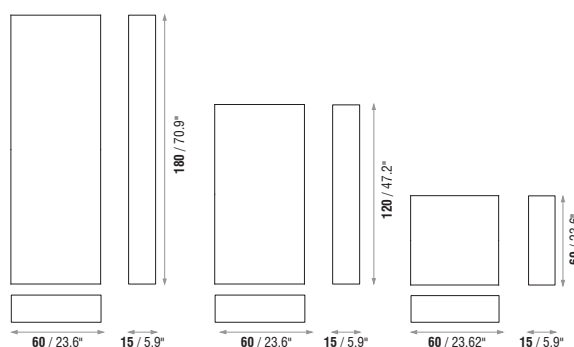

MODELS AND SIZES

MODELS	HEIGHT	WIDTH	DEPTH	WEIGHT
WAL180	180 cm (70.9 in)	60 cm (23.6 in)	15 cm (5.9 in)	19.7 Kg (43.43 lbs)
WAL120	120 cm (47.2 in)	60 cm (23.6 in)	15 cm (5.9 in)	13.8 Kg (30.42 lbs)
WAL060	60 cm (23.6 in)	60 cm (23.6 in)	15 cm (5.9 in)	6.9 Kg (15.21 lbs)

ABSORPTION COEFFICIENT

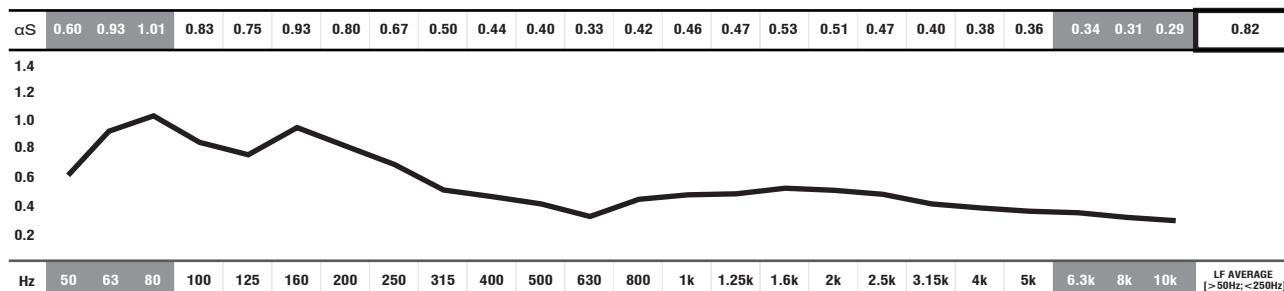

■ ABSORPTION COEFFICIENT: Values in accordance with the standards: EN 20654, ASTM C423 and EN 11654.

■ Values [$<100\text{Hz}$ and $>5\text{K}$] are Non Standard Values.

STANDARD FABRIC COLOURS



IMPORTANT NOTICES

- JOCAVI® accepts no responsibility for any printing errors. Specifications can be modified without prior notice, if technical or commercial reasons so require.
- RAL® is an international independent colour standard system partner for industry, trade, architecture and design. Should be consulted before placing any order.
- The colours shown on this catalogue are only a reference and an illustration of the products finishing. The colours shown are not binding because brightness, contrast and colour balance may vary due to the printing process.
- Colours may vary due to raw-material suppliers' changes and some differences may occur in tonal range.
- Wood and Fabric products are highly susceptible to change its appearance with humidity and temperature. Close attention must be paid to the storage conditions and the acclimatization before, during and after the installation.
- Typical Indoor Comfort Standards state a temperature range of 20°C - 27°C (68°F - 81°F), and a relative humidity of less than 60%. These would be considered as normal operational levels of JOCAVI® products' range.
- Despite all the standard sizes of all products, this model can be customised upon previous consultation. Sizes may vary slightly due to their production method and some inherent raw-materials characteristics.



BASSKEEPER ANGLE®

TUNED LF ABSORPTION PANEL



Projected cellulose on HD EPS or Fabric Finishings

Image of 120x40cm model Ref.:BKA120 (on the left) and Ref.:BKA120 applied (ambient image).

DESCRIPTION

The BASSKEEPER ANGLE® is a low-frequency absorption panel with an open resonance box. The attractive finish allows you to create your own luxurious design of your room. BASSKEEPER ANGLE® produces an overpowering effect in the corners of the room where the bass builds-up and is most often present. It can be assembled combined with its congener BASSKEEPER WALL®.

The BASSKEEPER ANGLE® and the BASSKEEPER WALL® have the same external appearance and are both bass traps. The BASSKEEPER ANGLE® is tuned to 63Hz and applied to corners, while the BASSKEEPER WALL® is tuned to 125Hz and is applied to walls or ceilings. This combination is a first-rate approach to tame low-frequency anomalies in your room.

In most cases, the combination of these two models solves all problems caused by the accumulation of low frequencies in the room, thus providing acoustic control of low frequencies.

FEATURES

- Tuned to 63Hz.
- LF Average absorption: **0.60/m²** (>50Hz; <250Hz).
- Raw material: HD EPS with Coloured Projectable Cellulose Finishing.
- Fire-resistance: Projectable Cellulose - Euroclass A2-s1,d0 (similar to old M0); EPS - Euroclass B-s3,d1 (similar to old M1).
- Application on 90° corners.
- Very easy to install.
- Other colours available upon consultation.
- Finishing options available in Fabric or Projected Cellulose on EPS.

TECHNICAL DRAWINGS

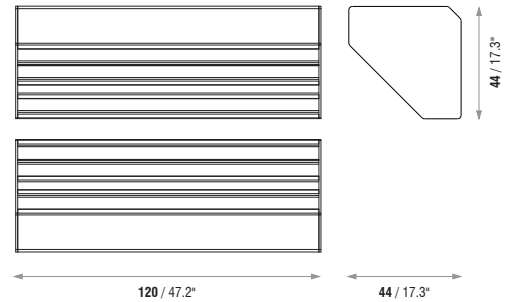

MODELS AND SIZES

MODELS	HEIGHT	WIDTH	DEPTH	WEIGHT
BKA120	120 cm (47.2 in)	44 cm (17.3 in)	44 cm (17.3 in)	3.8 Kg (8.38 lbs)

ABSORPTION COEFFICIENT

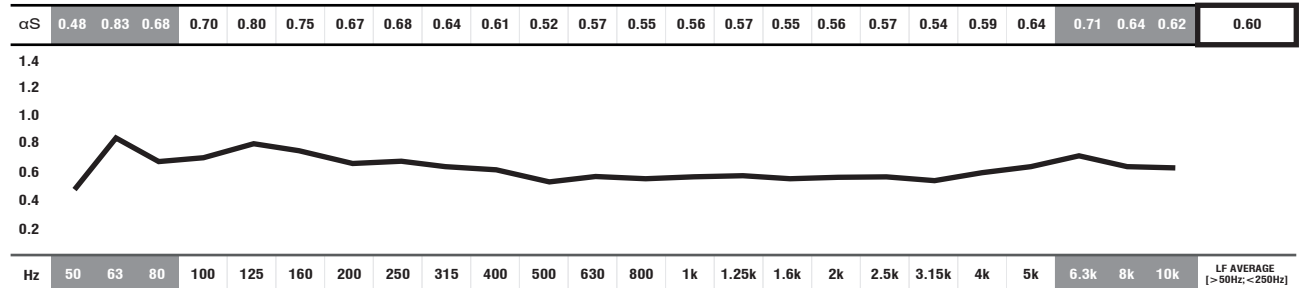

■ ABSORPTION COEFFICIENT: Values in accordance with the standards: EN 20654, ASTM C423 and EN 11654.

■ Values [$<100\text{Hz}$ and $>5\text{K}$] are Non Standard Values.

STANDARD FABRIC AND PROJECTED CELLULOSE FINISHING COLOURS

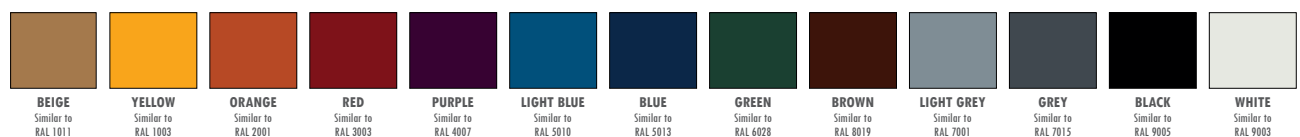

IMPORTANT NOTICES

- JOCAVI® accepts no responsibility for any printing errors. Specifications can be modified without prior notice, if technical or commercial reasons so require.
- RAL® is an international independent colour standard system partner for industry, trade, architecture and design. Should be consulted before placing any order.
- The colours shown on this catalogue are only a reference and an illustration of the products finishing. The colours shown are not binding because brightness, contrast and colour balance may vary due to the printing process.
- Colours may vary due to raw-material suppliers' changes and some differences may occur in tonal range.
- Typical Indoor Comfort Standards state a temperature range of 20°C - 27°C (68°F - 81°F), and a relative humidity of less than 60%. These would be considered as normal operational levels of JOCAVI® products' range.
- Sizes may vary slightly due to their production method and some inherent raw-materials characteristics.



BASSKEEPER WALL®

TUNED LF ABSORPTION PANEL



Projected cellulose on HD EPS or Fabric Finishings

Image of 120x60cm model Ref.:BKW120 (on the left) and Ref.:BKW120 applied (ambient image).

DESCRIPTION

The BASSKEEPER WALL® is the ATP™ solution a low-frequency absorption panel with an open resonance box that is meant to be mounted on walls and ceilings. The attractive finish allows you to create your own luxurious design in your room. BASSKEEPER WALL® has an active absorption for all types of ceiling and wall surfaces. When combined with the BASSKEEPER ANGLE®, it provides the best ATP™ choice among the low-frequency products. This combination is a first-rate approach to tame low-frequency anomalies in your room. In most cases, the combination of these two models solves all problems caused by the accumulation of low frequencies in the room, thus providing acoustic control of low frequencies. This bass trap is an open resonance box model, tuned to 125 Hz, while the BASSKEEPER ANGLE® is tuned to 63Hz, and you can match them. These two products together provide a true linear tool and a first-class approach to tame low frequencies and take perfect control of the basses. In most situations, these two models combined solve most problems caused by the excess of low frequencies in the room. Several colours are at your disposal.

FEATURES

- Tuned to 125Hz.
- LF Average absorption: **0.55/m²** [$>50\text{Hz}; <250\text{Hz}$].
- Raw material: HD EPS with Coloured Projectable Cellulose Finishing.
- Fire-resistance: Projectable Cellulose - Euroclass A2-s1,d0 (similar to old M0); EPS - Euroclass B-s3,d1 (similar to old M1).
- Very easy to install.
- Other colours available upon consultation.
- Finishing options available in Fabric or Projected Cellulose on EPS .

TECHNICAL DRAWINGS

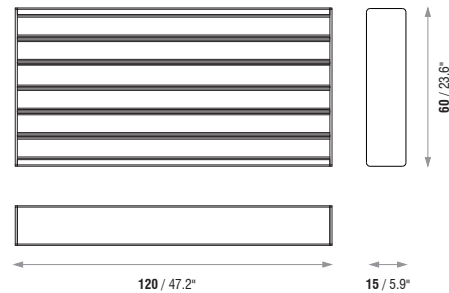

MODELS AND SIZES

MODELS	HEIGHT	WIDTH	DEPTH	WEIGHT
BKW120	120 cm (47.2 in)	60 cm (23.6 in)	15 cm (5.9 in)	3.1 Kg (6.83 lbs)

ABSORPTION COEFFICIENT

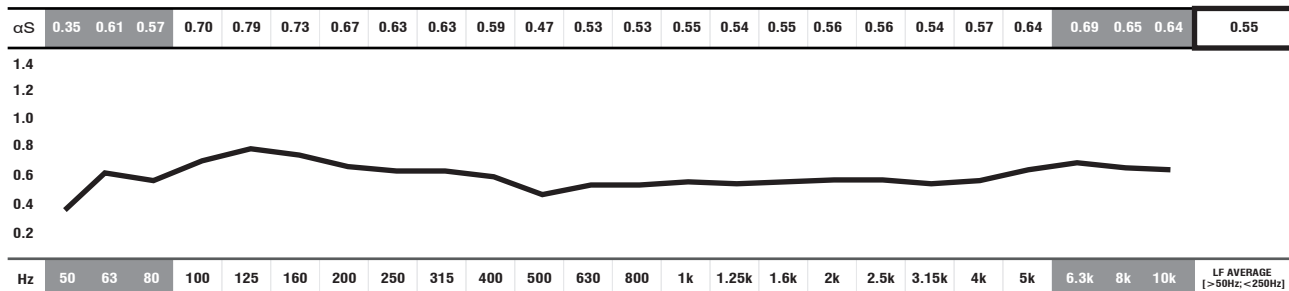

■ ABSORPTION COEFFICIENT: Values in accordance with the standards: EN 20654, ASTM C423 and EN 11654.

■ Values [$<100\text{Hz}$ and $> 5\text{K}$] are Non Standard Values.

STANDARD FABRIC AND PROJECTED CELLULOSE FINISHING COLOURS

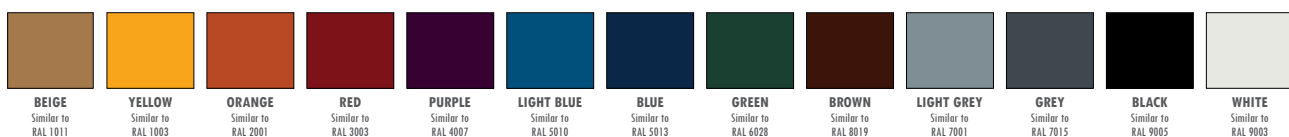

IMPORTANT NOTICES

- JOCAVI® accepts no responsibility for any printing errors. Specifications can be modified without prior notice, if technical or commercial reasons so require.
- RAL® is an international independent colour standard system partner for industry, trade, architecture and design. Should be consulted before placing any order.
- The colours shown on this catalogue are only a reference and an illustration of the products finishing. The colours shown are not binding because brightness, contrast and colour balance may vary due to the printing process.
- Colours may vary due to raw-material suppliers' changes and some differences may occur in tonal range.
- Typical Indoor Comfort Standards state a temperature range of 20°C - 27°C (68°F - 81°F), and a relative humidity of less than 60%. These would be considered as normal operational levels of JOCAVI® products' range.
- Sizes may vary slightly due to their production method and some inherent raw-materials characteristics.



LF CAMOU®

TUNED LF ABSORPTION PANEL



Image of 60x60cm model Ref.:LFA060 (on the left) and Ref.:LFA060 applied (ambient image).

DESCRIPTION

The LF CAMOU® is a low-frequency absorption panel suitable for applying in the 90° corners of rooms. The absorption peak of this panel is at 100 Hz. It combines a high-density foam box with JOCAVI®'s fabric finishing. It has exactly the same finishing as the CAMOU® absorbent panel, so we can combine the two models with the same aesthetics. The combined use with CAMOU® will increase the absorption of the nearest harmonic frequencies.

The closed resonance chamber has sufficient mass and density to provide a very concentrated and effective absorption coefficient. This panel will become one of the most efficient and inexpensive offers in the market for low-frequency absorbent materials.

This panel is mounted by pasting it with our recommended adhesive glue.

The LF CAMOU® is designed to fit and match the CAMOU® or any other 80mm thickness models.

In order to boost bass absorption, we recommend that you use a number of panels enough to fill all the edge corners of the room.

FEATURES

- Made up of high-density PU foam and Fabric finishing plate.
- LF Average absorption: **0.77/m²** [$>50\text{Hz}; <250\text{Hz}$].
- Tuned to 100 Hz.
- Fire-resistance: Fabric - Euroclass B (similar to old M1); HD PU Foam Euroclass B-s3,d1 (similar to old M1).
- Designed to fit and match any 80mm thickness models.
- Very easy to install.

TECHNICAL DRAWINGS

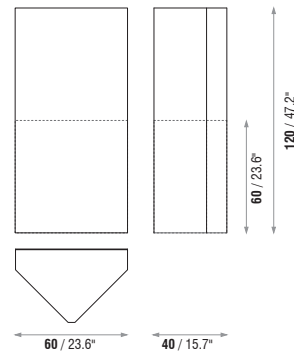

MODELS AND SIZES

MODELS	HEIGHT	WIDTH	DEPTH	WEIGHT
LFA120	120 cm (47.2 in)	40 cm (15.7 in)	40 cm (15.7 in)	8.8 Kg (19.40 lbs)
LFA060	60 cm (23.6 in)	40 cm (15.7 in)	40 cm (15.7 in)	4.4 Kg (9.70 lbs)

ABSORPTION COEFFICIENT

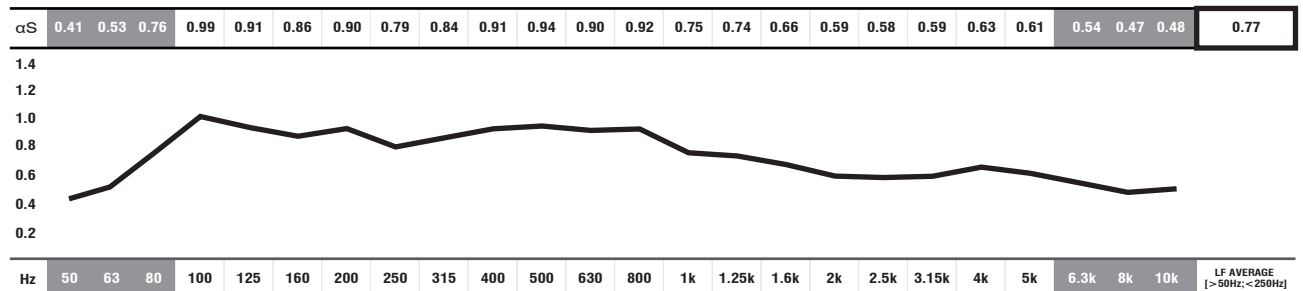

■ ABSORPTION COEFFICIENT: Values in accordance with the standards: EN 20654, ASTM C423 and EN 11654.

■ Values [$<100\text{Hz}$ and $>5\text{K}$] are Non Standard Values.

STANDARD FABRIC COLOURS



REGULAR FOAM COLOURS



IMPORTANT NOTICES

- JOCAVI® accepts no responsibility for any printing errors. Specifications can be modified without prior notice, if technical or commercial reasons so require.
- RAL® is an international independent colour standard system partner for industry, trade, architecture and design. Should be consulted before placing any order.
- The colours shown on this catalogue are only a reference and an illustration of the products finishing. The colours shown are not binding because brightness, contrast and colour balance may vary due to the printing process.
- Colours may vary due to raw-material suppliers' changes and some differences may occur in tonal range.
- Typical Indoor Comfort Standards state a temperature range of 20°C - 27°C (68°F - 81°F), and a relative humidity of less than 60%. These would be considered as normal operational levels of JOCAVI® products' range.
- Sizes may vary slightly due to their production method and some inherent raw-materials characteristics.



LF COSMOS[®]

TUNED LF ABSORPTION PANEL



Image of 60x60cm model Ref.:LFO060 (on the left) and Ref.:LFO060 applied (ambient image).

DESCRIPTION

The LF COSMOS[®] is a low-frequency absorbent panel suitable for applying in the 90° corners of rooms. The absorption peak of this panel is at 100 Hz. It combines a high-density foam box with JOCAVI[®]'s melamin faced board finishings. It has exactly the same finishing as the COSMOS[®] absorbent panel, so we can combine the two models with the same aesthetics. The combined use with COSMOS[®] will increase the absorption of the nearest harmonic frequencies.

The closed resonance chamber has sufficient mass and density to provide a very concentrated and effective absorption coefficient. This panel will become one of the most efficient and inexpensive offers in the market for low-frequency absorbent materials.

This panel is mounted by pasting it with our recommended adhesive glue. The LF COSMOS[®] is designed to fit and match the COSMOS[®] or any other 80mm thickness models.

In order to boost bass absorption, we recommend that you use a number of panels enough to fill all the edge corners of the room.

FEATURES

- Made up of high-density PU foam and Rigid melamine faced board plate.
- LF Average absorption: **0.75/m²** [$>50\text{Hz}; <250\text{Hz}$].
- Tuned to 100 Hz.
- Fire-resistance: Melamine Faced Board - Euroclass B-s2,d0 (similar to old M1); HD PU Foam Euroclass B-s3,d1 (similar to old M1).
- 4 perforations and 6 melamine faced boards finishings.
- Designed to fit and match any 80mm thickness models.
- Very easy to install.

TECHNICAL DRAWINGS

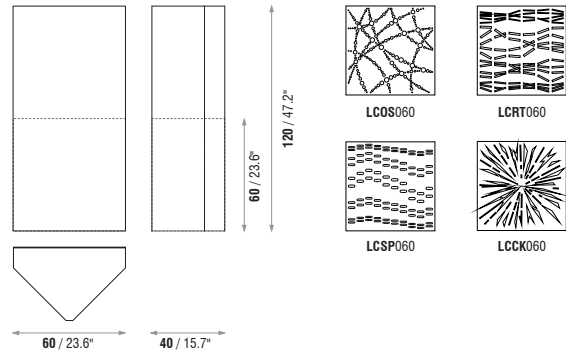

MODELS AND SIZES

MODELS	HEIGHT	WIDTH	DEPTH	WEIGHT
LFO120	120 cm (47.2 in)	40 cm (15.7 in)	40 cm (15.7 in)	8.8 Kg (19.40 lbs)
LFO060	60 cm (23.6 in)	40 cm (15.7 in)	40 cm (15.7 in)	4.4 Kg (9.70 lbs)

ABSORPTION COEFFICIENT

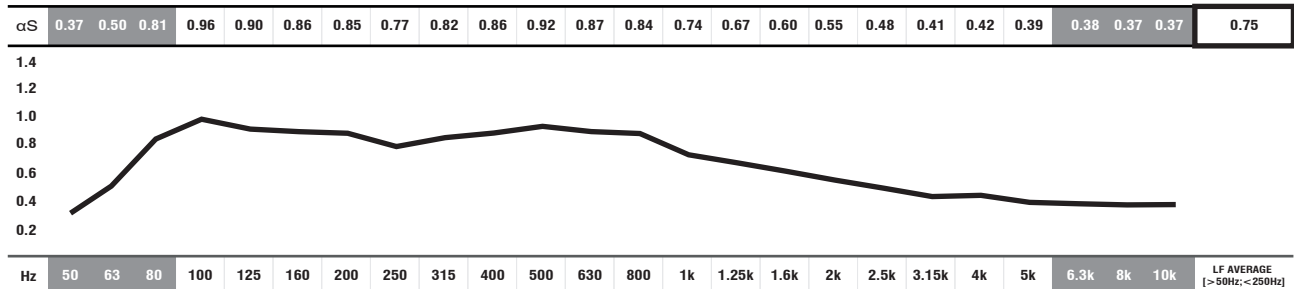

■ ABSORPTION COEFFICIENT: Values in accordance with the standards: EN 20654, ASTM C423 and EN 11654.

■ Values [$<100\text{Hz}$ and $>5\text{K}$] are Non Standard Values.

WOOD FACED BOARD FINISHINGS



REGULAR FOAM COLOURS



IMPORTANT NOTICES

- JOCAVI[®] accepts no responsibility for any printing errors. Specifications can be modified without prior notice, if technical or commercial reasons so require.
- The colours shown on this catalogue are only a reference and an illustration of the products finishing. The colours shown are not binding because brightness, contrast and colour balance may vary due to the printing process.
- Colours may vary due to raw-material suppliers' changes and some differences may occur in tonal range.
- Due to its natural origin, wood-based products will always present natural imperfections inherent to the organic nature. And for similar reasons, they will also present traces of old-age in the course of time.
- Wood and Fabric products are highly susceptible to change its appearance with humidity and temperature. Close attention must be paid to the storage conditions and the acclimatization before, during and after the installation.
- Typical Indoor Comfort Standards state a temperature range of 20°C - 27°C (68°F - 81°F), and a relative humidity of less than 60%. These would be considered as normal operational levels of JOCAVI[®] products' range.
- Despite all the standard sizes of all products, this model can be customised upon previous consultation. Sizes may vary slightly due to their production method and some inherent raw-materials characteristics.



LF TONE®

TUNED LF ABSORBENT PANEL

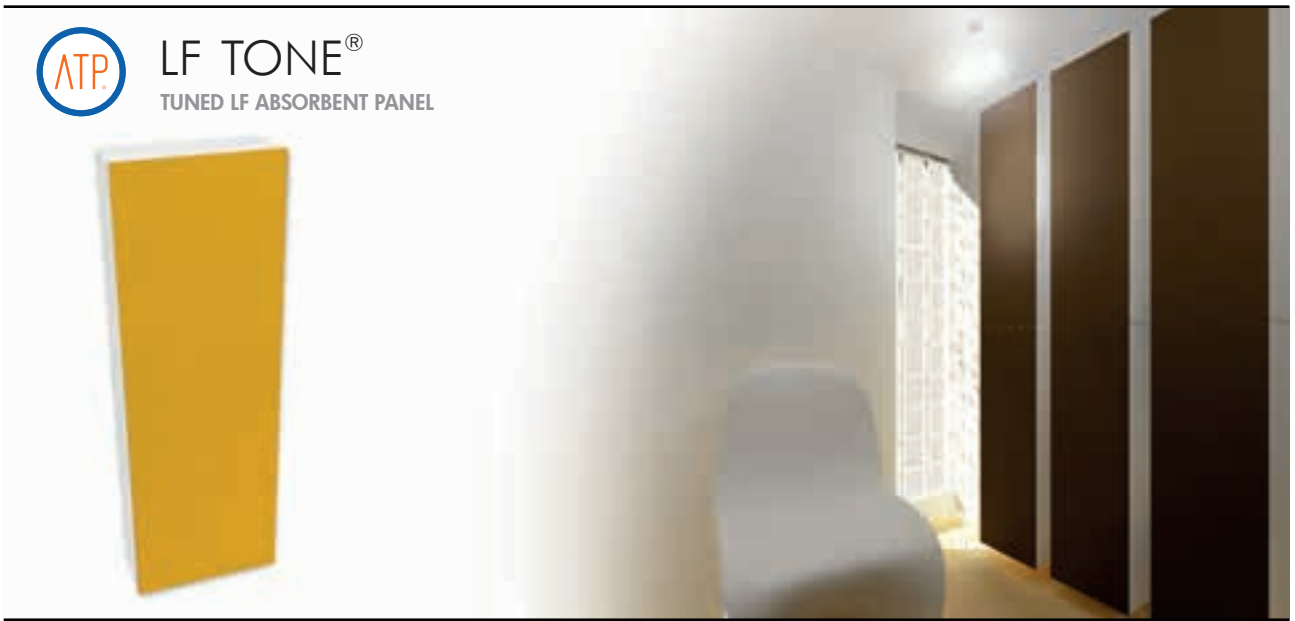

Image of 120x40cm model Ref.:LFT120 (on the left) and Ref.:LFT120 applied (ambient image).

DESCRIPTION

The LF TONE® is a low-frequency membrane absorbent panel to be used on walls or ceilings. It was conceived as a whole box and with a membrane designed to provide more sensitivity to the low pressure sound waves. It is tuned to 250Hz and it also has an effective performance at lower frequencies.

The finishing of the LF TONE® is made from JOCAVI®'s fabric and it can be matched with any other fabric finishing models with the same aesthetics.

The LF TONE® aims to reduce the acoustic anomalies caused by the excess of low frequencies and it takes perfect control of the basses specially in music rooms, studios, home-theatres, rehearsal rooms, etc.. It provides one of the best choices among the low-frequency ATP® products.

It can be directly glued to the existing surfaces by using our recommended adhesive glue.

TECHNICAL DRAWINGS

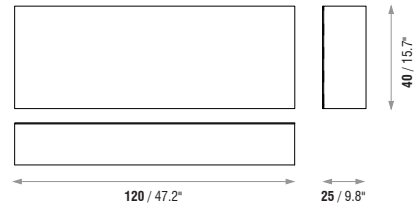

FEATURES

- Fabric-coated acoustic regular foam on a rigid framework.
- LF Average absorption: **0.65/m²** [$>50\text{Hz}; <250\text{Hz}$].
- Tuned to 250 Hz.
- Fire-resistance: Fabric - Euroclass B (similar to old M1); EPS - Euroclass B-s3,d1 (similar to old M1).
- Several colours.
- Very easy to install.

MODELS AND SIZES

MODELS	HEIGHT	WIDTH	DEPTH	WEIGHT
LFT120	120 cm (47.2 in)	40 cm (15.7 in)	25 cm (9.8 in)	1.7 Kg (3.75 lbs)

ABSORPTION COEFFICIENT

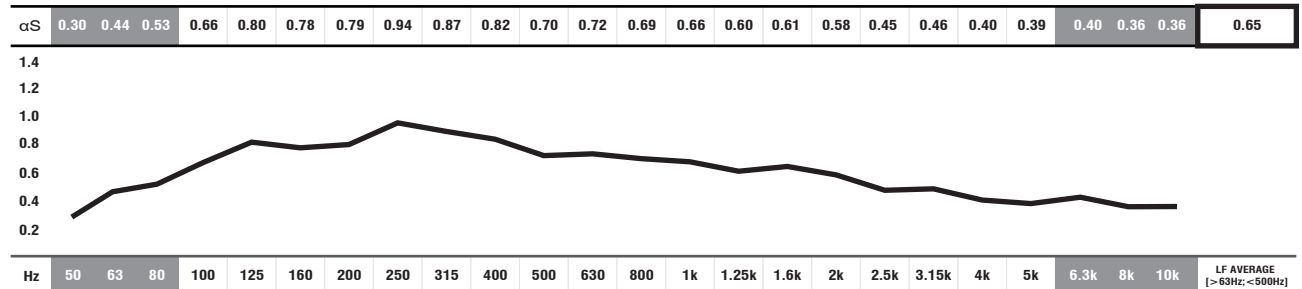

■ ABSORPTION COEFFICIENT: Values in accordance with the standards: EN 20654, ASTM C423 and EN 11654.

■ Values [$<100\text{Hz}$ and $>5\text{K}$] are Non Standard Values.

STANDARD FABRIC COLOURS - FRONT



EPS BOX COLOURS

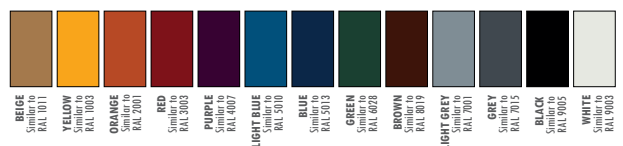

IMPORTANT NOTICES

- JOCAVI® accepts no responsibility for any printing errors. Specifications can be modified without prior notice, if technical or commercial reasons so require.
- RAL® is an international independent colour standard system partner for industry, trade, architecture and design. Should be consulted before placing any order.
- The colours shown on this catalogue are only a reference and an illustration of the products finishing. The colours shown are not binding because brightness, contrast and colour balance may vary due to the printing process.
- Colours may vary due to raw-material suppliers' changes and some differences may occur in total range.
- Typical Indoor Comfort Standards state a temperature range of 20°C - 27°C (68°F - 81°F), and a relative humidity of less than 60%. These would be considered as normal operational levels of JOCAVI® products' range.
- Sizes may vary slightly due to their production method and some inherent raw-materials characteristics.



SLIMBASS ANGLE®

TUNED ABSORPTION PANEL

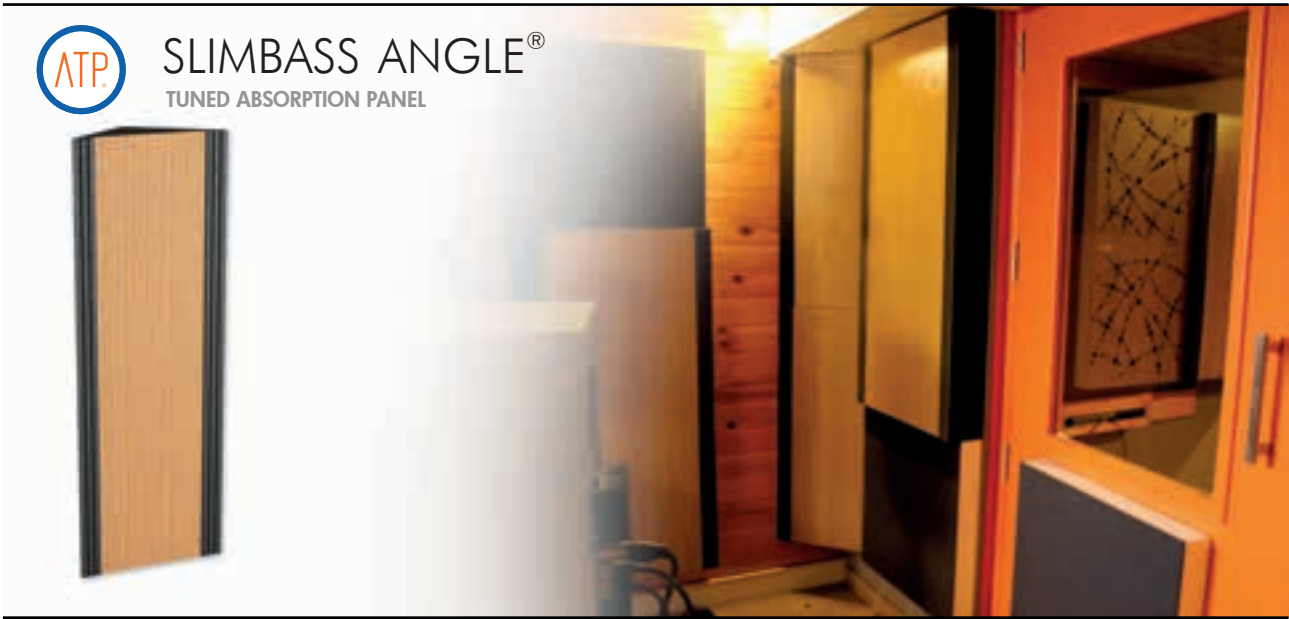

Image of 120x30cm model Ref.:SLB120 (on the left) and Ref.:SLB120 applied (ambient image).

DESCRIPTION

Music rooms, studios, rehearsal rooms, etc., requires surfaces that are efficient at absorbing low-frequencies.

ATP® proposes the SLIMBASS ANGLE® absorbent panel for the absorption of low-frequencies.

It is made of high-quality controlled-cell regular acoustic foam with a wooden-like melamine faced board finish plate, forming inside it a 160 Hz closed resonance box.

The SLIMBASS ANGLE® panel has a thin and elegant design, which is appropriate for the 90° corners of the room's walls or ceilings.

TECHNICAL DRAWINGS

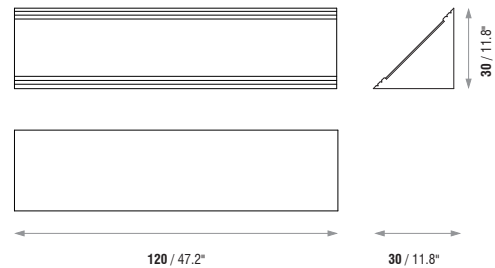

FEATURES

- Raw material: Regular Foam and rigid Melamine Faced Board plate.
- LF Average absorption: **0.55/m²** [$>50\text{Hz}; <250\text{Hz}$].
- Fire-resistance: Melamine Faced Board - Euroclass B-s2,d0 (similar to old M1); PU Foam Euroclass B-s3,d1 (similar to old M1).
- Very easy to install.

MODELS AND SIZES

MODELS	HEIGHT	WIDTH	DEPTH	WEIGHT
SLB120	120 cm (47.2 in)	30 cm (11.8 in)	30 cm (11.8 in)	1.4 Kg (3.09 lbs)

ABSORPTION COEFFICIENT

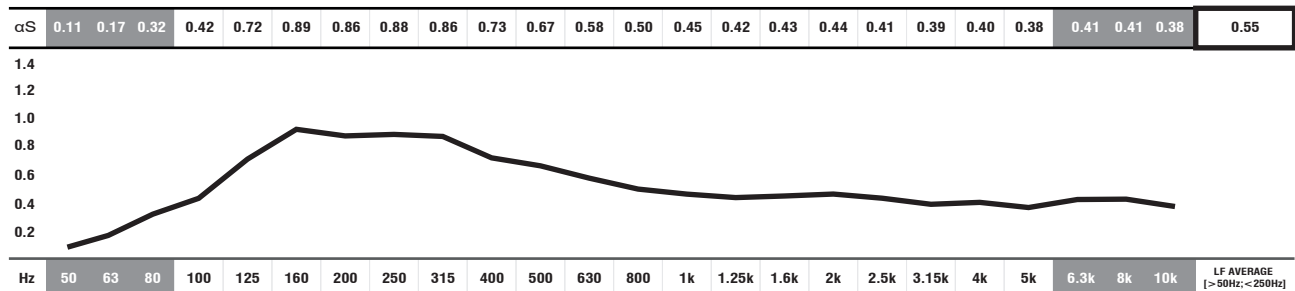

■ ABSORPTION COEFFICIENT: Values in accordance with the standards: EN 20654, ASTM C423 and EN 11654.

■ Values [$<100\text{Hz}$ and $>5\text{K}$] are Non Standard Values.

WOOD FACED BOARD FINISHINGS



REGULAR FOAM COLOURS



IMPORTANT NOTICES

- JOCAVI® accepts no responsibility for any printing errors. Specifications can be modified without prior notice, if technical or commercial reasons so require.
- The colours shown on this catalogue are only a reference and an illustration of the products finishing. The colours shown are not binding because brightness, contrast and colour balance may vary due to the printing process.
- Colours may vary due to raw-material suppliers' changes and some differences may occur in tonal range.
- Due to its natural origin, wood-based products will always present natural imperfections inherent to the organic nature. And for similar reasons, they will also present traces of old-age in the course of time.
- Wood and Fabric products are highly susceptible to change its appearance with humidity and temperature. Close attention must be paid to the storage conditions and the acclimatization before, during and after the installation.
- Typical Indoor Comfort Standards state a temperature range of 20°C - 27°C (68°F - 81°F), and a relative humidity of less than 60%. These would be considered as normal operational levels of JOCAVI® products' range.
- Despite all the standard sizes of all products, this model can be customised upon previous consultation. Sizes may vary slightly due to their production method and some inherent raw-materials characteristics.



TRAP® 30R/30S/40

TUNED LF ABSORPTION PANEL

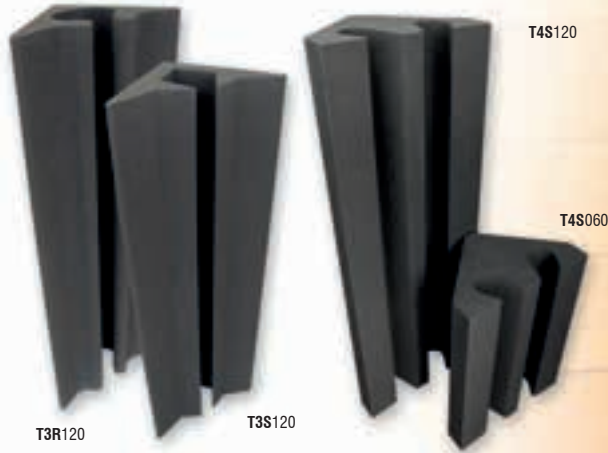

Image of 120x30cm models Ref.:T3R120, Ref.:T3S120 and Ref.:T4S120 and T4S060(on the left) and Ref.:T4S120 applied (ambient image).

DESCRIPTION

TRAP 30S® and TRAP 30R® are node reduction tools of low-frequencies. They are made of high-quality controlled-cell, self-extinguishable M1 fire-retardant acoustic foam. Bass corners' absorbers are substantially adequate to control nodes in rooms. This simple and affordable solution provides immediate results for those who do not want time-consuming building solutions. The TRAP 30S® and TRAP 30R® are effective low-frequency smoothing panels at a price affordable to everybody. This model proposes two optional shapes: one with straight lines and another one with curved lines. The TRAP® 40S is a low frequencies reduction tool. It is made of high-quality controlled-cell, self-extinguishable M1 fire-retardant acoustic foam. Bass corners' absorbers are substantially recommended to control Low Frequencies in rooms. The TRAP® 40S is an effective low-frequency absorbent panel used for corners, meant to be placed in 90° corners. This model proposes an attractive shape with curved lines at a very affordable price.

FEATURES

- **FINISHINGS AVAILABLE:** Regular Foam or the Velvety Finishing.
- **LF Average Absorption:**
 - TRAP 30S/R **0.84/m²** [$>50\text{Hz}$; $<250\text{KHz}$];
 - TRAP 40S **0.86/m²** [$>50\text{Hz}$; $<250\text{KHz}$].
- **MELAMINE FOAM** - Flame resistance: Euroclass B-s1,d0 (similar to old M1 France, Germany B1,GB class1, USA V0/HF1).
- **ACOUSTIC FOAM** - Flame resistance: Euroclass B-s3,d1 (similar to old M1).
- Very easy to install.

TECHNICAL DRAWINGS

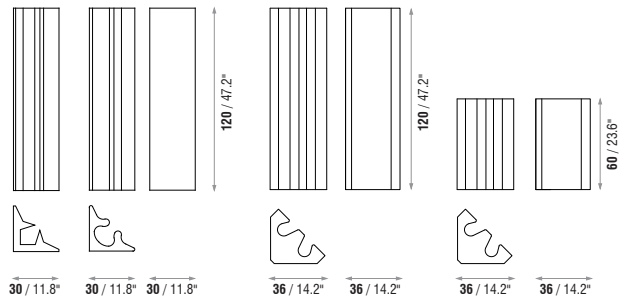

MODELS AND SIZES

MODELS	HEIGHT	WIDTH	DEPTH	WEIGHT
T3S120	120 cm (47.2 in)	30 cm (11.8 in)	30 cm (11.8 in)	0.9 Kg (1.98 lbs)
T3R120	120 cm (47.2 in)	30 cm (11.8 in)	30 cm (11.8 in)	0.9 Kg (1.98 lbs)
T4S120	120 cm (47.2 in)	36 cm (14.2 in)	36 cm (14.2 in)	1.8 Kg (3.97 lbs)
T4S060	60 cm (23.6 in)	36 cm (14.2 in)	36 cm (14.2 in)	0.9 Kg (1.98 lbs)

ABSORPTION COEFFICIENT

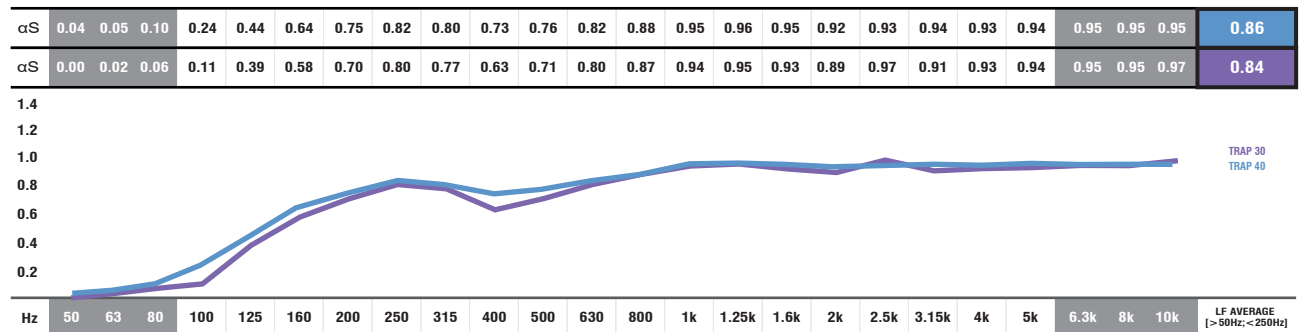

■ ■ ABSORPTION COEFFICIENT: Values in accordance with the standards: EN 20654, ASTM C423 and EN 11654. ■ Values [$<100\text{Hz}$ and $>5\text{K}$] are Non Standard Values.

REGULAR AND MELAMINE FOAM COLOURS



VELVETY COLOURS (only available in Melamine Foam)



IMPORTANT NOTICES

- JOCAVI® accepts no responsibility for any printing errors. Specifications can be modified without prior notice, if technical or commercial reasons so require.
- The colours shown on this catalogue are only a reference and an illustration of the products finishing. The colours shown are not binding because brightness, contrast and colour balance may vary due to the printing process.
- Colours may vary due to raw-material suppliers' changes and some differences may occur in tonal range.
- Typical Indoor Comfort Standards state a temperature range of 20°C - 27°C (68°F - 81°F), and a relative humidity of less than 60%. These would be considered as normal operational levels of JOCAVI® products' range.
- Despite all the standard sizes of all products, this model can be customised upon previous consultation. Sizes may vary slightly due to their production method and some inherent raw-materials characteristics.



VOCAL MIC REFLECTION FILTER®

ATP® STUDIO LINE



Image of VMRF filter Ref.:VMRF and the POP OFF Ref.:PO applied.

FEATURES

- Acoustic bell for microphone.
- Insulates the microphone from the room effect.
- Acoustically conditions the microphone.
- Use: recording and broadcast studios.
- Installation: direct fastening to the microphone tripod.
- Packaging: 1 unit.

SIZES AND COLOURS

MODELS	HEIGHT	WIDTH	DEPTH	WEIGHT
VMRF ●	38 cm (15.0 in)	58 cm(22.8 in)	24 cm (9.4 in)	2.1 Kg (4.63 lbs)

DESCRIPTION

This parabola-shaped accessory is a creativity aid to sound engineers who search for the perfect loudness for each project. It enables significant sound variations by adjusting the position between the piece and the microphone.

The bell that defines its shape is sealed, which improves the insulation of the room environment effect. It reduces the amount of energy reflected from the room surfaces, walls, floor and ceiling, thus making the sound of voices or instruments more authentic.

The VMRFiter® is made of four different raw materials with no metal components, thus not causing any change to the magnetic field of microphones. The size and shape of this piece were optimised with the aim to maximise the absorption inside the VMRFiter®, in order not to influence the colouring or polarity of each microphone but influence the surrounding acoustics.

The VMRFiter's interior is made of three different permeable absorbent materials which provide it with interesting features.

It is a great piece to record singers, broadcasters, acoustic and electric guitars and basses, flutes, wind instruments, etc.. It works even if your room is not duly treated.

It can be mounted on the same tripod of the microphone itself. However, if mounted on a separate tripod, it is easier to tune the VMRFiter's best positioning in relation to the microphone that is being used.



BABS® TWO SIDED SELF-STANDING ABSORBENT PANEL

ATP® STUDIO LINE

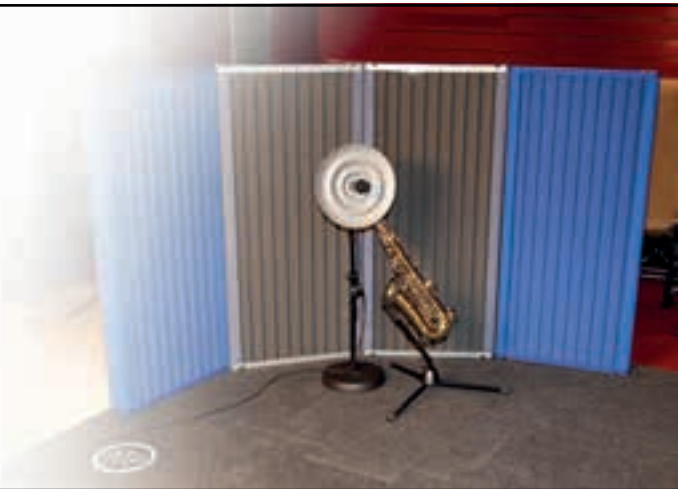

Image of BABS model Ref.:BABS.

FEATURES

- Portable acoustic blind.
- **NRC: 0.79 (FOAM FACE); 0.68 (FABRIC FACE).**
- Ideal to put around instruments, amplifiers and speakers.
- Use: recording studios and mobile studios.
- Installation: easy to mount on the base provided.
- Packaging: 2 units.

SIZES AND COLOURS

MODELS	HEIGHT	WIDTH	DEPTH	WEIGHT
BABS ●●●●	117 cm (46.1 in)	55 cm (21.7 in)	9 cm (3.5 in)	4.8 Kg (10.58 lbs)

DESCRIPTION

The BABS® is an acoustic blind system which is ideal to have in your recording room. It provides an outstanding acoustic division between each instrument or amplifier, thus optimising the separation between microphones during sound capturing.

It is also the ideal solution for portable acoustic treatment. It can be used to improvise a rehearsal room, recording room or control room that surrounds a monitoring system, etc.

It is provided with a foot for each module. It is easily mounted by placing it on your room's floor and adjusts to the intended situations.

BABS's two faces are acoustically and aesthetically different. One of them absorbs more than the other one, also within different ranges of the sound spectrum, thus providing various options of loudness and modulation to your room. For different audition or sound capturing purposes, this versatile system allows to adapt the rooms' acoustic disturbances, thus becoming a very useful tool for your projects.

It can be provided (optional) with a carrying bag for each two pieces, thus being very light and easy to carry.

IMPORTANT NOTICES

- JOCAVI® accepts no responsibility for any printing errors. Specifications can be modified without prior notice, if technical or commercial reasons so require.
- The colours shown on this catalogue are only a reference and an illustration of the products finishing. The colours shown are not binding because brightness, contrast and colour balance may vary due to the printing process.
- Colours may vary due to raw-material suppliers' changes and some differences may occur in tonal range. Sizes may vary slightly due to their production method and some inherent raw-materials characteristics.



HORNDIFFUSER®

ATP® STUDIO LINE



Image of HORNDIFFUSER model Ref.:HD.

FEATURES

- Acoustic reflector for wind instruments.
- Increases the return of the direct sound back to the musician.
- Insulates the sound coming from the monitors.
- Installation: by embedding in the microphone or microphone tripod.
- Use: at live and in studio
- Packaging: 1 unit

SIZES AND COLOURS

MODELS	HEIGHT	WIDTH	DEPTH	WEIGHT
HD ●●○	Ø29 cm (11.4 in)	1 cm (0.4 in)	-	0.1 Kg (0.22 lbs)

DESCRIPTION

This accessory works as an acoustic mirror for trumpeters, trombonists and saxophonists. It is applied around the microphone. It provides the musician with the direct return of the sound that he/she played. Besides this important advantage to the musician, it also offers benefits to the sound technician or engineer, since it insulates the microphone from the sound that comes from the stage monitors by creating a sort of a wall behind the microphone. Its curvature shapes are optimised with the aim of focusing on the musician the reflection of his/her sound in the most efficient way.



MIC PROTECTOR®

ATP® STUDIO LINE

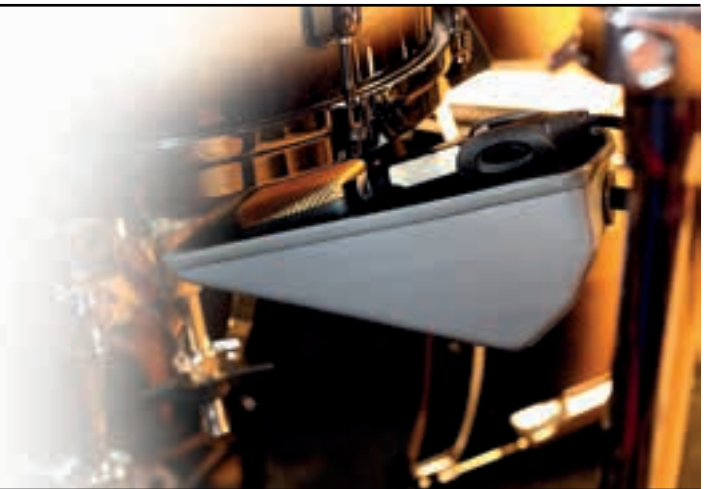

Image of MIC PROTECTOR model applied Ref.:MP.

FEATURES

- Insulation protector for microphones.
- Acoustically separates sound capturing.
- Fits most microphone models.
- Installation: on a microphone tripod.
- Packaging: box with 1 or 3 units.
- Use: live and studio.

SIZES AND COLOURS

MODELS	HEIGHT	WIDTH	DEPTH	WEIGHT
MP ●●	22 cm (8.7 in)	11 cm (4.3 in)	8.5 cm (3.3 in)	0.1 Kg (0.22 lbs)

DESCRIPTION

This accessory is more useful to sound engineers and technicians than to musicians themselves. This accessory is original, unique, highly necessary and in high demand. It is often used by sound engineers to improvise and make bricolage, when they need to use something that produces this insulation effect while capturing several instruments that are close to each other. The MP1 surrounds the microphone individualising the sound that is captured. Especially at live events, it modifies the behaviour of noise gates, compressors, dynamics' controllers inserts and provides them with better autonomy and easiness of control. It is ideal to use under and over snare drums, as well as floor toms, jazz bass drums, guitar amplifiers, basses and wherever each one's imagination will dictate.

IMPORTANT NOTICES

- JOCAVI® accepts no responsibility for any printing errors. Specifications can be modified without prior notice, if technical or commercial reasons so require.
- The colours shown on this catalogue are only a reference and an illustration of the products finishing. The colours shown are not binding because brightness, contrast and colour balance may vary due to the printing process.
- Colours may vary due to raw-material suppliers' changes and some differences may occur in tonal range. Sizes may vary slightly due to their production method and some inherent raw-materials characteristics.



NEARFIELD BASE®

ATP® SPEAKER LINE



Image of 8x25x30cm model Ref.:NFB I and NFB II.

FEATURES

- Anti-vibration speaker base available in two sizes.
- Use: nearfield and midfield speakers.
- Position adjustment in the vertical angle.
- Installation: to be placed on working consoles or speaker stands.
- Fits most models.
- Packaging: 2 units.

SIZES AND COLOURS

MODELS	HEIGHT	WIDTH	DEPTH	WEIGHT
NFB I ●	8 cm (3.1 in)	25 cm (9.8 in)	30 cm (11.8 in)	0.35 Kg (0.77 lbs)
NFB II ●	8 cm (3.1 in)	35 cm (13.8 in)	40 cm (15.7 in)	0.53 Kg (1.17 lbs)

DESCRIPTION

The NFB® is an essential accessory for your music audition room or studio control room. This quite inexpensive piece works miracles on your room's sound. It minimizes the propagation of physical vibrations to the pieces installed on the workbenches, which also end up playing and vibrating thus causing spurious noises.

The innovation of the NFB's design consists on the possibility of adjusting the vertical angle from the speaker's position to the audition sweet spot, thus adding one more important benefit to this accessory.

All these benefits will thus allow you to optimise the sound of your room. You can position this piece in relation to the monitors and reduce the unwanted vibrations.

This accessory is meant to be used in nearfields. The two existing sizes, NFB I and NFB II, adjust to most models of this type of speakers.



SUBWOOFER BASE®

ATP® SPEAKER LINE



Image of the two SUB WOOFER BASE models Ref.:SWB I and Ref.:SWB II.

FEATURES

- Anti-vibration speaker base available in two sizes.
- Use: sub-woofer.
- Installation: to be placed on the floor
- Fits most models.
- Packaging: 1 unit.

SIZES AND COLOURS

MODELS	HEIGHT	WIDTH	DEPTH	WEIGHT
SWB I ●	9 cm (3.5 in)	40 cm (15.7 in)	40 cm (15.7 in)	0.96 Kg (2.12 lbs)
SWB II ●	9 cm (3.5 in)	58 cm (22.8 in)	50 cm (19.7 in)	1.67 Kg (3.68 lbs)

DESCRIPTION

The SWB® is a key piece for your set-up when you use a sub-woofer. This accessory is essential and quite inexpensive, and reduces the vibrations caused by the physical propagation to the accessories present in the room.

The top part is stiff and causes a weight distribution across the whole area in contact with the floor.

The sizes are in accordance with most manufacturers of this type of speakers. There are two different sizes, SWB I and SWB II.

IMPORTANT NOTICES

- JOCAVI® accepts no responsibility for any printing errors. Specifications can be modified without prior notice, if technical or commercial reasons so require.
- The colours shown on this catalogue are only a reference and an illustration of the products finishing. The colours shown are not binding because brightness, contrast and colour balance may vary due to the printing process.
- Colours may vary due to raw-material suppliers' changes and some differences may occur in tonal range. Sizes may vary slightly due to their production method and some inherent raw-materials characteristics.



DRUMBASE®

ATP® DRUM KIT LINE



Image of 197x197x2.7cm model Ref.:DB and the carrying-bag.

FEATURES

- Anti-vibration platform.
- Packaging: 1 kit (9 pieces)
- Installation: by embedding; Use: live and studio.
- Fits the standard size of stage platforms.
- Manufactured with 60% recycled material.
- Provided with carrying-bag.
- Other sizes available on demand.

SIZES AND COLOURS

MODELS	HEIGHT	WIDTH	DEPTH	WEIGHT
DB ●	197 cm (77.6 in)	197 cm (77.6 in)	2.7 cm (1.1 in)	26 Kg (57.32 lbs)

DESCRIPTION

The ATP® DRUMBASE® is an anti-vibration platform for drum sets which is composed of 9 pieces that fit together and make up a total area of 4m² (2mt x 2mt).

The material used in its base is non-skid, closed-cell, made of recycled rubber, and its density is duly adjusted. In order to exert the best inertia on the physical propagation of energy, we took into account the weight of both the instrument and the musician, as well as the weight of the reverberated movements that are made when the musician is playing.

It is easily mounted by fitting together the several modules on the floor or the stage. It just takes two minutes for your DRUMBASE® to be ready. The 9 modules fit together in a perfect way, thereby preventing them from getting separated due to oscillations during performance. It has a carpet finishing.

The DRUMBASE® is a great tool to optimise the sound of your drum kit and is excellent to be used at live or in studio.

We offer a carrying-bag and a pencil to mark the position of the several pieces that are on the platform



KICK PAD® KIT

ATP® DRUM KIT LINE



Image of the KICK PAD KIT® (inside) the KICK PAD, Ref.:KP and the PUNCH MASTER, Ref.:PM (outside).

FEATURES

- Kit includes: **KICK PAD®** and **PUNCH MASTER®**
- Making the beat clearer. Full-bodied and more defined sound.
- Cancel unwanted harmonics. Lowers the bass drum resonance frequency.
- For all bass drums from 14" and 20" depth.
- For Live or Studio performances.
- Very useful for the drummer and the sound engineer.

SIZES AND COLOURS

MODELS	HEIGHT	WIDTH	DEPTH	WEIGHT
KP ●	5 cm (1.97 in)	2x 35 cm (14.0 in)	35/50 cm (14/20 in)	0.6 Kg (1.32 lbs)
PM ●●	14 cm (5.5 in)	14 cm (5.5 in)	4 cm (1.38 in)	0.1 Kg (0.22 lbs)

DESCRIPTION

To tune and get good sound out of a bass drum is sometimes a very hard task as an essential base of a drum kit needs to be properly treated.

The KICK PAD KIT® was created to absorb unwanted harmonics which are out of tune with the bass drum note, thus making the beat clearer, full-bodied and more defined.

Composed of two parts; PUNCH MASTER® is the front drumhead port and KICK PAD® which is the inner absorbent pad. These are provided together allowing you to fully control the bass drum head's vibration accentuating its punch and deepness at every beat. Its ultra light material and attractive design makes it look distinct and stylish.

KICK PAD KIT® is very useful for the drummer and the sound engineer, providing great results either in live or in studio performances.

IMPORTANT NOTICES

- JOCAVI® accepts no responsibility for any printing errors. Specifications can be modified without prior notice, if technical or commercial reasons so require.
- The colours shown on this catalogue are only a reference and an illustration of the products finishing. The colours shown are not binding because brightness, contrast and colour balance may vary due to the printing process.
- Colours may vary due to raw-material suppliers' changes and some differences may occur in tonal range. Sizes may vary slightly due to their production method and some inherent raw-materials characteristics.



WALLBLIND®

ABSORBENT PANEL - WHEELED ACOUSTIC BLIND



Image of 200x120cm models Ref.:WBLG200 and WBL200 (on the left) and Ref.:WBLG200 (ambient image).

DESCRIPTION

Studios' large rooms are adequate to record joint "takes", with all the band's elements playing at the same time. The WALLBLIND® is recommended to physically divide the musicians or the several sound sources between each instrument or amplifier, thus minimizing both the complicity and sound contamination from the several instruments in relation to the microphones.

The WALLBLIND® is a portable acoustic blind system which is ideal for your recording room. It provides a remarkable acoustic division while permitting to choose the most pleasant face for the instrument that it surrounds. You can choose from two faces with different acoustic and aesthetic features: one side has a high-density EPS profile, which is hardened with a ceramic painting film, with good diffusing features, while the other side has an optimised profile cut for open-cell acoustic foam, thus being quite more absorbent.

This product has a resistant rigid structure with big wheels and allows several modules to be coupled with quite tight union angles.

FEATURES

- Wheeled acoustic blind.
- NRC: **0.66/m²**.
- Fire-resistance: Regular Foam - Euroclass B-s3,d1 (similar to old M1); EPS - Euroclass B-s3,d1 (similar to old M1).
- Solid structure, excellent insulation.
- Two acoustically different faces (diffusing and absorbent).
- Ideal to separate and surround instruments.
- Place: recording and rehearsal studios.
- Installation: easy to install on the base provided.

TECHNICAL DRAWINGS

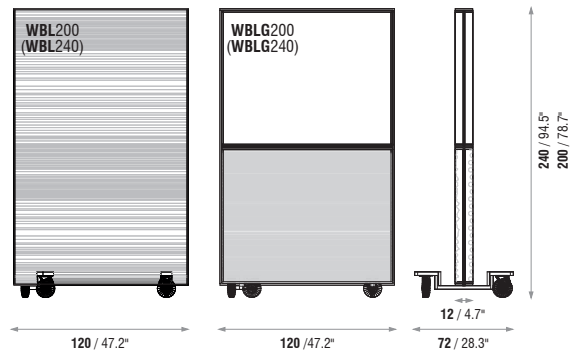

MODELS AND SIZES

MODELS	HEIGHT	WIDTH	DEPTH	WEIGHT
WBL240	240 cm (94.5 in)	120 cm (47.2 in)	12 cm (4.7 in)	64.9 Kg (143.08 lbs)
WBLG240	240 cm (94.5 in)	120 cm (47.2 in)	12 cm (4.7 in)	74.4 Kg (164.02 lbs)
WBL200	200 cm (78.7 in)	120 cm (47.2 in)	12 cm (4.7 in)	51.4 Kg (113.32 lbs)
WBLG200	200 cm (78.7 in)	120 cm (47.2 in)	12 cm (4.7 in)	62 Kg (136.69 lbs)

ABSORPTION COEFFICIENT

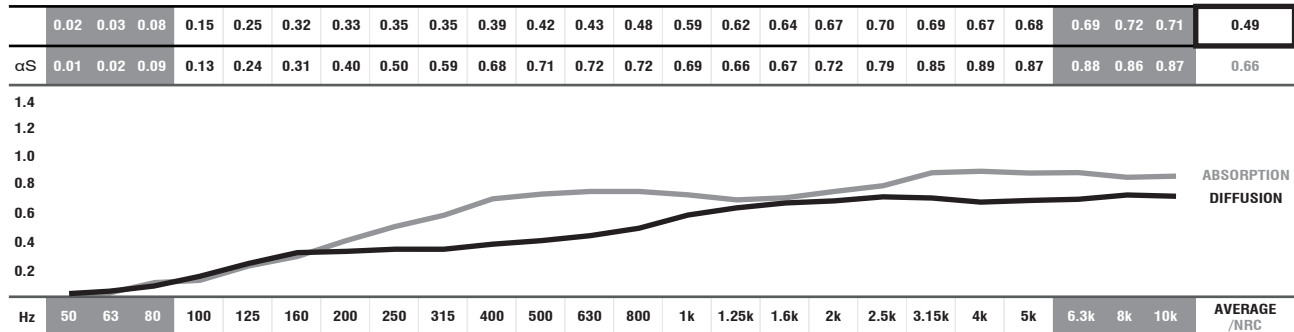

STANDARD EPS RAL COLOURS



ACOUSTIC FOAM COLOURS



IMPORTANT NOTICES

- JOCAVI® accepts no responsibility for any printing errors. Specifications can be modified without prior notice, if technical or commercial reasons so require.
- RAL® is an international independent colour standard system partner for industry, trade, architecture and design. Should be consulted before placing any order.
- The colours shown on this catalogue are only a reference and an illustration of the products finishing. The colours shown are not binding because brightness, contrast and colour balance may vary due to the printing process.
- Colours may vary due to raw-material suppliers' changes and some differences may occur in total range.
- Typical Indoor Comfort Standards state a temperature range of 20°C - 27°C (68°F - 81°F), and a relative humidity of less than 60%. These would be considered as normal operational levels of JOCAVI® products' range.
- Sizes may vary slightly due to their production method and some inherent raw-materials characteristics.



WALLPART®

ABSORBENT PANEL - WHEELED ACOUSTIC BLIND



WPT200



Image of 200X120cm models: WPT200 on the left and details on the right (ambient image).

DESCRIPTION

Acoustic separators are very common to divide work environments, namely in offices and other places where it is necessary to acoustically separate voices or other noise sources.

WALLPART® is a portable acoustic blind system, created as a perfect solution for your office, studio, and open spaces that need to be physically separated for acoustic purposes. It provides a remarkable acoustic division due to its sound-absorbing capacities besides being an eco-friendly product made with Polyester fiber, lightweight and semi-rigid material with great sound-absorbing properties.

WALLPART® is recommended to physically divide spaces from several sound sources, thus minimizing both the complicity and sound contamination, and clearly improving speech intelligibility.

This product has a resistant rigid structure that can be fitted with wheels and it allows several modules to be coupled with quite tight union angles, forming a free-flowing surface. Other sizes can be manufactured and customized.

FEATURES

- Portable acoustic blind with wheel option.
- NRC: **0.66/m²**
- Fire-resistance: PET - Euroclass B-s3,d2.
- Aluminum solid structure, excellent insulation.
- Ideal for open spaces .
- Applications: ideal for open spaces, recording and rehearsal studios.
- Installation: easy to install on the provided base.

TECHNICAL DRAWINGS

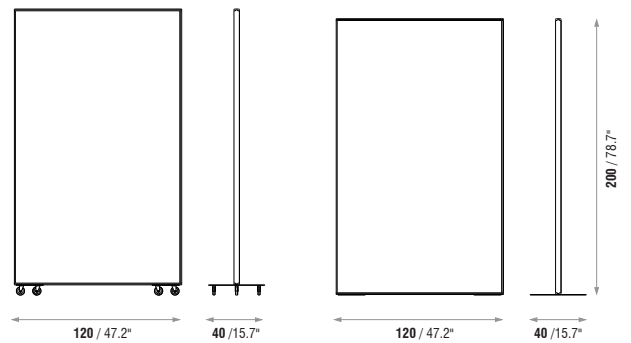

MODELS AND SIZES

MODELS	HEIGHT	WIDTH	DEPTH	WEIGHT
WPT200	200 cm (787.7 in)	120 cm (47.2 in)	4 cm (1.57 in)	21.4 Kg (47.18 lbs)
WPTW200	200 cm (78.7 in)	120 cm (47.2 in)	4cm (1.57 in)	32 Kg (70.55 lbs)

ABSORPTION COEFFICIENT

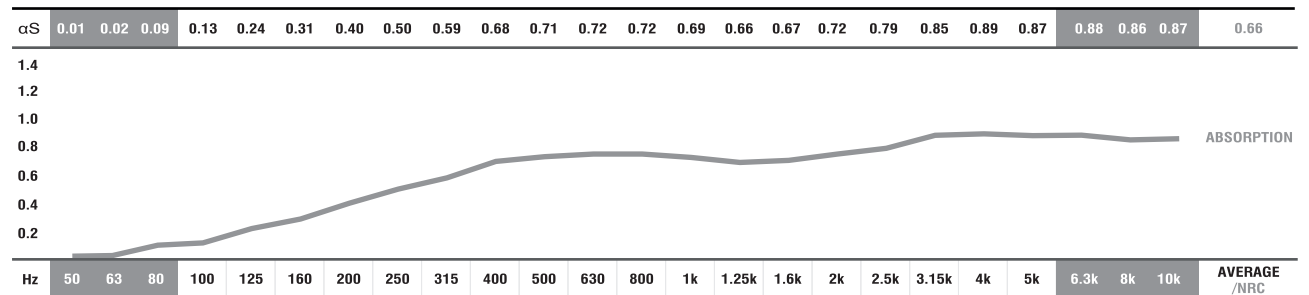

■ ABSORPTION COEFFICIENT: Values in accordance with the standards: EN 20654, ASTM C423 and EN 11654.

■ Values [$<100\text{Hz}$ and $>5\text{K}$] are Non Standard Values.

STANDARD PET COLOURS



GREY M28 Similar to RAL 7031



BEIGE M01 Similar to RAL 9001



BLUE M22 Similar to RAL 5002



WHITE M05 Similar to RAL 9003

IMPORTANT NOTICES

- JOCAVI® accepts no responsibility for any printing errors. Specifications can be modified without prior notice, if technical or commercial reasons so require.
- The colours shown on this catalogue are only a reference and an illustration of the products finishing. The colours shown are not binding because brightness, contrast and colour balance may vary due to the printing process.
- Colours may vary due to raw-material suppliers' changes and some differences may occur in tonal range.
- Typical Indoor Comfort Standards state a temperature range of 20°C - 27°C (68°F - 81°F), and a relative humidity of less than 60%. These would be considered as normal operational levels of JOCAVI® products' range.
- Despite all the standard sizes of all products, this model can be customised upon previous consultation. Sizes may vary slightly due to their production method and some inherent raw-materials characteristics.



FIXED DIFFUSION ACOUSTIC SHELLS

EFFECTFUSER® AcSh® • DYNAMICFLOW® AcSh® • WOODFOIL® AcSh® • PLURA® AcSh® • DIAMOND® AcSh® • NEO3Q® AcSh®



DESCRIPTION

The diffusing acoustic shells are acoustic treatment elements intended for large volume rooms, such as theatres or auditoriums with a stage where orchestral concerts or mere recitals take place. These acoustic diffusing components are meant to project the non-amplified original sound from the stage to the audience. This will enable people to hear the sound coming directly from its sound sources and instruments, without the electro-acoustic inherent characterization or colouring. This panel also aims to enable the stage and the room to be within the same space and not separate in two by the mouth of the stage. JOCA VI™s models have been designed at the specific scale of these needs. Due to its shape and depth, they also have a high diffusion coefficient on medium/low frequencies. The all are large-sized diffusers that provide a very homogeneous diffusion within the diffuse and sound spectrum. Manufactured in HIPS (except WOODFOIL® in wood) with a rigid framework, these pieces can be coupled and multiplied in order to suit each project's demands. When mounted, several modules should be grouped so as to obtain an area that is proportional to each space. Mounting: They can be hung from the ceiling in a strategic position in order to obtain sound diffusion in the required angles. They can also be mounted with a motorized rigging system from the stage ceiling. These elements / modules are fastened with steel cables by using appropriate mounting accessories. Their low weight makes mounting easier. As with any other JOCAVI® diffusion panel, these models can also be applied on false ceilings, flat ceilings or walls.

MAIN FEATURES

To adjust the diffusing properties of these models to the room where this product is applied, the placement of the pieces must be taken into account in order to obtain its best performance, bearing in mind these two types of diffusion:

DIFFUSION WITH COMPRESSION EFFECTS (only EFX COMBI and EFX Plate)

It emphasizes the sound diffusion with a smaller covering angle, effective at a longer incidence distance.

Features: efficient at a longer distance; smaller incidence angle; higher sound level.

DIFFUSION WITH SCATTERING EFFECTS (only EFX COMBI and EFX Plate)

It emphasizes the sound diffusion at a wider covering angle, effective at a shorter incidence distance.

Features: efficient at a shorter distance; less sound level; wider incidence angle.

SCATTERING EFFECTS (example for the EFX180COMBI)

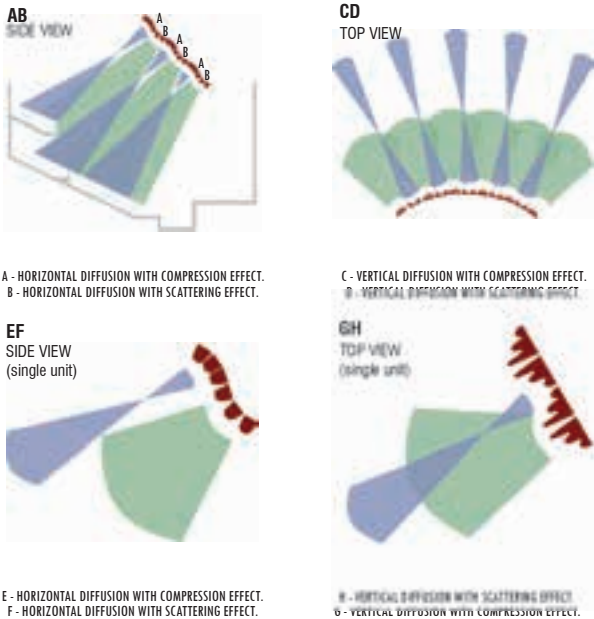

A - HORIZONTAL DIFFUSION WITH COMPRESSION EFFECT.
B - HORIZONTAL DIFFUSION WITH SCATTERING EFFECT.

C - VERTICAL DIFFUSION WITH COMPRESSION EFFECT.
D - VERTICAL DIFFUSION WITH SCATTERING EFFECT.

EF
SIDE VIEW
(single unit)

GH
TOP VIEW
(single unit)

E - HORIZONTAL DIFFUSION WITH COMPRESSION EFFECT.
F - HORIZONTAL DIFFUSION WITH SCATTERING EFFECT.

G - VERTICAL DIFFUSION WITH SCATTERING EFFECT.
H - VERTICAL DIFFUSION WITH COMPRESSION EFFECT.

MODELS AND SIZES*

MODELS	HEIGHT	WIDTH	DEPTH	WEIGHT
EFX COMBI 180	180 cm (70.9 in)	120 cm (47.2 in)	32 cm (12.6 in)	57 Kg (125.66 lbs)
EFX Plate 120	120 cm (47.2 in)	120 cm (47.2 in)	32 cm (12.6 in)	38 Kg (83.78 lbs)
DYN Plate 180	180 cm (70.9 in)	120 cm (47.2 in)	13 cm (5.1 in)	34 Kg (74.96 lbs)
DYN Plate 120	120 cm (47.2 in)	120 cm (47.2 in)	13 cm (5.1 in)	25 Kg (55.12 lbs)
WFL Plate 180	180 cm (70.9 in)	120 cm (47.2 in)	23 cm (9.1 in)	38 Kg (83.78 lbs)
WFL Plate 120	120 cm (47.2 in)	120 cm (47.2 in)	23 cm (9.1 in)	27 Kg (59.52 lbs)
PLR Plate 180	180 cm (70.9 in)	120 cm (47.2 in)	16 cm (6.3 in)	33 Kg (72.75 lbs)
PLR Plate 120	120 cm (47.2 in)	120 cm (47.2 in)	16 cm (6.3 in)	24 Kg (52.91 lbs)
DIA Plate 180	180 cm (70.9 in)	120 cm (47.2 in)	14 cm (5.5 in)	34 Kg (74.96 lbs)
DIA Plate 120	120 cm (47.2 in)	120 cm (47.2 in)	14 cm (5.5 in)	25 Kg (55.12 lbs)
N3Q Plate 180	180 cm (70.9 in)	120 cm (47.2 in)	16 cm (6.3 in)	33 Kg (72.75 lbs)
N3Q Plate 120	120 cm (47.2 in)	120 cm (47.2 in)	16 cm (6.3 in)	24 Kg (52.91 lbs)

*Specifications can be modified without prior notice, if technical or commercial reasons so require.

STANDARD HIPS COLOURS



YELLOW Similar to RAL 1003
ORANGE Similar to RAL 2008
RED Similar to RAL 3001
GREEN Similar to RAL 6001
BLUE Similar to RAL 5013
PURPLE Similar to RAL 4005
LILAC Similar to RAL 4009
BROWN Similar to RAL 8017
CREAM Similar to RAL 1001
BLACK Similar to RAL 9005
GREY Similar to RAL 7042
WHITE Similar to RAL 9003

WOOD VENEER FINISHINGS



PINE OAK CHERRY MAHOGANY WENGE BLACK-BROWN

IMPORTANT NOTICES

- JOCAVI® accepts no responsibility for any printing errors. Specifications can be modified without prior notice, if technical or commercial reasons so require.
- RAL® is an international independent colour standard system partner for industry, trade, architecture and design. Should be consulted before placing any order.
- The colours shown on this catalogue are only a reference and an illustration of the products finishing. The colours shown are not binding because brightness, contrast and colour balance may vary due to the printing process.
- Colours may vary due to raw-material suppliers' changes and some differences may occur in tonal range.
- Typical Indoor Comfort Standards state a temperature range of 20°C - 27°C (68°F - 81°F), and a relative humidity of less than 60%. These would be considered as normal operational levels of JOCAVI® products' range.
- Sizes may vary slightly due to their production method and some inherent raw-materials characteristics.



PORTABLE DIFFUSION ACOUSTIC SHELLS

DYNAMICFLOW® AcSh® • WOODFOIL® AcSh® • PLURA® AcSh® • DIAMOND® AcSh® • NEO3Q® AcSh®

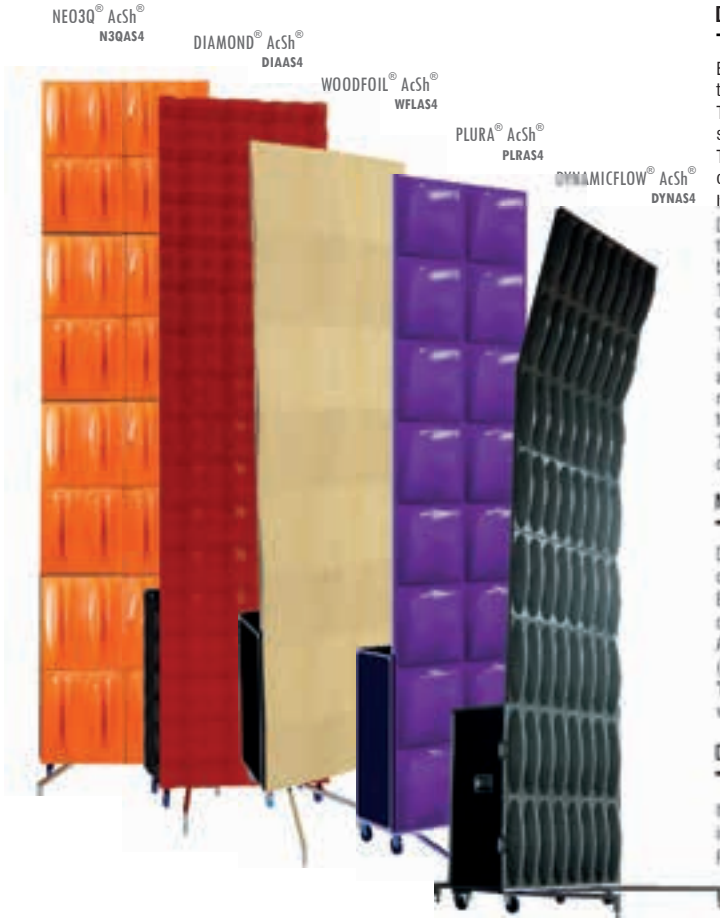

DESCRIPTION

Based on works and experiments in the field of sound wave diffusion and the positive aspects that result from the presence of diffusers in rooms, we have built these acoustic diffuser.

Therefore, we are presenting new design proposals that are less common in diffusion structures designed for mobile use.

These models are an easy-to-install portable acoustic diffusion shells meant to be used in certain types of musical concerts.

It is a piece that changes the room's acoustics by enhancing its features.

Diffusion shells are acoustic treatment elements used in large volume rooms, such as theatres and auditoriums. They may also be used outdoors for the performance of concerts by large orchestras or just recitals.

The installation of these acoustic diffusion components is meant to project the non-amplified original sound from the stage towards the audience.

This will enable to hear the sound that comes directly from the sound sources and instruments, without the characterization or colouring inherent to the use of electroacoustics. These shells also enable the stage and the room to be within the same space and not separate in two by the mouth of the stage. These pieces do not need any preparation prior to their installation, just a free stage with good access.

They must be coupled and multiplied in such a way that is adequate to each project in order to obtain a diffusing area that is proportionate to the space in question.

MAIN FEATURES

Depending on the space available on the stage, more or less elements may be used in order to form the shape of a perfect shell.

Built on a modular configuration with 120x120cm pieces, up to four modules can be coupled in height, thus totalling a diffusing homogeneous surface of 480 x 120cm. All AS4 models have 500x125cm (196.9"x49.2") and the AS3, 380x125cm (149.6"x49.2").

These models are a large-sized diffusers that provides a very homogeneous diffusion within the sound and diffuse spectrum.

DIFFUSION WITH SCATTERING EFFECTS

emphasizes the sound diffusion at a wider covering angle, effective at a shorter incidence distance.

Features: efficient at a shorter distance; less sound level; wider incidence angle.

SCATTERING EFFECTS (example for the DYNAS4)

A SIDE VIEW



A - VERTICAL DIFFUSION WITH SCATTERING EFFECT.

B TOP VIEW



B - HORIZONTAL DIFFUSION WITH SCATTERING EFFECT.

C SIDE VIEW (single unit)

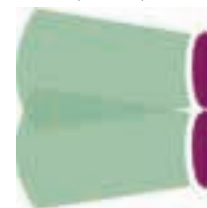

C - VERTICAL DIFFUSION WITH SCATTERING EFFECT.

D TOP VIEW (single unit)



D - HORIZONTAL DIFFUSION WITH SCATTERING EFFECT.

STANDARD HIPS COLOURS



IMPORTANT NOTICES

- JOCAVI® accepts no responsibility for any printing errors. Specifications can be modified without prior notice, if technical or commercial reasons so require.
- RAL® is an international independent colour standard system partner for industry, trade, architecture and design. Should be consulted before placing any order.
- The colours shown on this catalogue are only a reference and an illustration of the products finishing. The colours shown are not binding because brightness, contrast and colour balance may vary due to the printing process.
- Colours may vary due to raw-material suppliers' changes and some differences may occur in tonal range.
- Typical Indoor Comfort Standards state a temperature range of 20°C - 27°C (68°F - 81°F), and a relative humidity of less than 60%. These would be considered as normal operational levels of JOCAVI® products' range.
- Sizes may vary slightly due to their production method and some inherent raw-materials characteristics.

MODELS AND SIZES IN FLIGHT-CASE*

MODELS	HEIGHT	WIDTH	DEPTH	WEIGHT
DYNAS4	165 cm (65.0 in)	127 cm (50.0 in)	73.3 cm (28.9 in)	170 Kg (374.79 lbs)
DYNAS3	165 cm (65.0 in)	127 cm (50.0 in)	56 cm (22.0 in)	145 Kg (319.67 lbs)
WFLAS4	165 cm (65.0 in)	127 cm (50.0 in)	114 cm (44.9 in)	175 Kg (385.51 lbs)
WFLAS3	165 cm (65.0 in)	127 cm (50.0 in)	85 cm (33.5 in)	152 Kg (335.10 lbs)
PLRAS4	165 cm (65.0 in)	127 cm (50.0 in)	85.3 cm (33.6 in)	170 Kg (374.79 lbs)
PLRAS3	165 cm (65.0 in)	127 cm (50.0 in)	65 cm (25.6 in)	145 Kg (319.67 lbs)
DIAAS4	165 cm (65.0 in)	127 cm (50.0 in)	79.3 cm (31.2 in)	165 Kg (363.76 lbs)
DIAAS3	165 cm (65.0 in)	127 cm (50.0 in)	60.5 cm (23.8 in)	140 Kg (308.65 lbs)
N3QAS4	165 cm (65.0 in)	127 cm (50.0 in)	85.3 cm (33.6 in)	165 Kg (363.76 lbs)
N3QAS3	165 cm (65.0 in)	127 cm (50.0 in)	65 cm (25.6 in)	140 Kg (308.65 lbs)
WFLAS4 (120)	165 cm (65.0 in)	127 cm (50.0 in)	120 cm (47.2 in)	250 Kg (551.16 lbs)
WFLAS3 (120)	165 cm (65.0 in)	127 cm (50.0 in)	92 cm (36.2 in)	207.5 Kg (457.46 lbs)

*Specifications can be modified without prior notice, if technical or commercial reasons so require.

WOOD VENEER FINISHINGS



When symphony and chamber orchestras, soloists and opera singers perform in conventional theatres, they encounter problems with the projection of the sound and their voice due to the fact that the sound produced on stage is not properly scattered by diffusion materials. The sound produced by the orchestra is scattered unevenly in all directions, depending on the instruments, and requires an acoustic shell to project it towards the audience. The only way to not lose the sound level and musicality of the orchestra is to place acoustic diffusion shells around it.

To project the sound, diffusion panels shaped like a shell need to be installed facing the audience, which direct and project the sound in that direction. Acoustic shells may be portable so they can be placed around the stage and/or suspended from the ceiling above the stage and there are a number of models available for this.

Spaces such as theatres and auditoriums, where classical music performances are held, are usually high volume rooms. Audience noise all too often leads to reliance on electro-acoustic amplification which can alter the sound of the instruments. Musicians, singers and musical directors prefer the natural colour of their instruments and voices and therefore prefer to avoid the use of microphones etc.

The use of our AS[®] acoustic shells increases the natural sound level as produced by the instruments. This means that the sound is directed towards the audience instead of being lost in the orchestra pit, naturally increasing the acoustic pressure level in the room, producing a balanced diffusion over the whole range of the sound spectrum.

Our acoustic study uses ray tracing simulation, which is perfect for previewing the sound. We can therefore guarantee an increase in sound level, an homogeneous dispersion of acoustic energy and the consequent increase in the room's reverberation time.

AS[®] WHO WE ARE

On the market for 10 years, AS[®] is a brand of the JOCAVI[®] group, which specialises in the sale and hire of highly specialised acoustic shells, conceived in Jocavi[®] Paineis Acústicos Lda.'s R&D labs in Portugal.

We prepare projects to advise clients on the best shell for each space.

We do long duration rental contracts for events that are regularly held in the same venue.

We sell for permanent installation in theatres and auditoriums where these acoustic diffusers are suitable for the main activity.

We also carry out the installation and acoustic verification of our shells and can provide maintenance contracts.

We are Acoustic Shell, AS[®], a company dedicated to acoustic diffusion shells.

SHELL VERSATILITY

Unlike the original acoustic shells made of stone in Roman open-air amphitheatres, today's acoustic shells used in performance rooms have to be versatile and discreet so that their placement does not hinder the use of the space for the different types of performances held there. Our shells were developed and built with lightweight, attractive materials, which facilitate their practical use as much as possible. They can be adapted to the orchestra by changing the number of modules needed and by adjusting their positioning for each orchestra layout.

This stage equipment is easily assembled and disassembled and is inconspicuous when not in use.

ACOUSTIC BEHAVIOUR

The purpose of acoustic shells is to prevent acoustic energy, sound, from being lost or wasted in the orchestra pit, and direct it towards the audience.

How this is done is particularly important. Normally acoustic shells are used that are no more than a flat, convex or concave pieces of varnished plywood. Due to their large size, these shells return the acoustic energy in very tight angles of incidence and also do not have a balanced scattering coefficient versus frequency. Or rather, they do not scatter all the frequencies uniformly, scattering high frequencies more than mids/lows.

Our acoustic shells are specifically designed to also return the mid/low frequencies to the room. These use JOCAVI[®]'s acoustic diffusion panels which are developed to obtain the best balance in diffusion over the sound spectrum. This gives an excellent, distributed angular coverage and better balance in diffusion values over a broader range of the sound spectrum, which is therefore better for the mid/low frequencies.

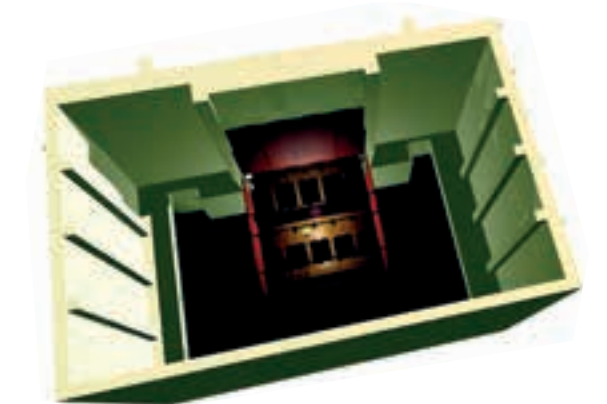
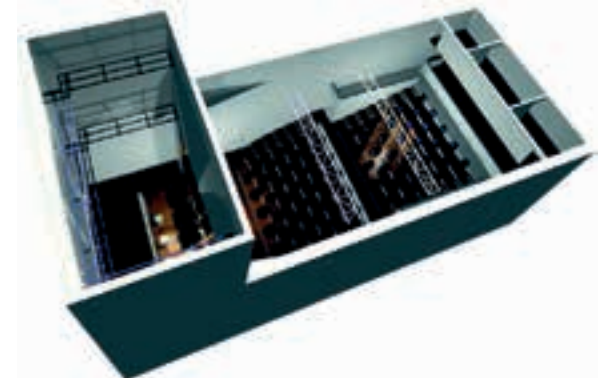
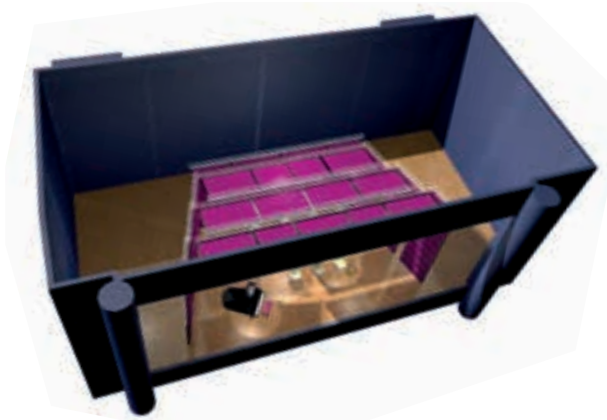

BENEFITS FOR THE ORCHESTRA AND THE MAESTRO

Acoustic comfort for musicians and musical directors is fundamental. It is impossible to get a good sound in a room with bad acoustics. This is frustrating for musicians, maestros and sound technicians alike as there is little or nothing they can do to improve the sound.

A room's acoustics is a fundamental problem that has to do with its physical structure, which can only be attenuated by the use of acoustic materials.

The quality of the interpretation of musical pieces may be enhanced when conditions are excellent. The acoustic shell harmonises the sound, enabling musicians to hear each other clearly, which is more enjoyable for them and facilitates playing in unison. It also allows the several groups of instruments of the orchestra to be enhanced or moderated according to the Maestro's taste.

AS[®] FIXED SHELLS

Fixed acoustic shells come in lateral, background and ceiling modules. These allow various angulations to be defined according to the degrees of incidence towards the audience.

These modules are suspended above the stage using aluminium and steel cables. They may be moved manually or using a system electric engines where the most common positions can be pre-programmed.

When not in use, the shells can be placed together completely inconspicuously.

AS[®] PORTABLE SHELLS

Portable acoustic shells are composed of four 120cm x 120cm modules which can be transported in flight cases. The casing is part of the shell's structure which means the case does not have to be stored away when the shell is used. The various modules are just placed in an arc on the stage floor. Their placement and number can be adapted to each orchestra according to the number and position of the musicians.

Portable shells are versatile, allowing diverse configurations according to the musical formation, and the easy access of musicians and instruments, besides quick assembly and disassembly.

Its wheeled box is easily transported, and when not in use can be kept out of the way in storage.

FEATURES

- Naturally increases the acoustic pressure level in the room, enhancing diffusion.
- The natural sound level actually produced by the instruments is increased.
- Offers unique acoustic diffusion characteristics.
- The AcSh[®] shell system enhances the real dimension of a concert hall.
- Versatile options for any performance room, easy and quick to assemble.
- Attractive, in a variety of colours and models.
- For theatres, auditoriums or spaces for classical orchestra concerts.

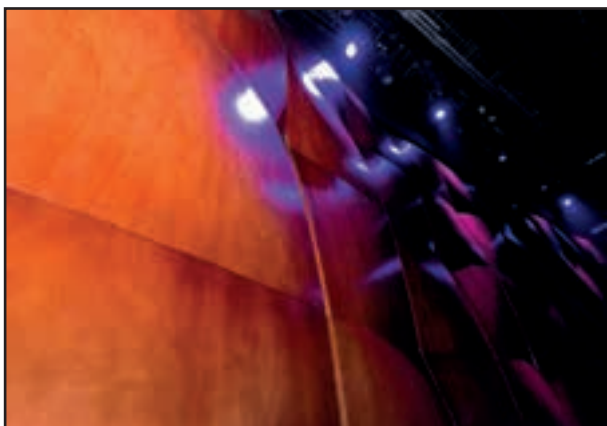



Image of 120x60cm model Ref.:ECOABLw (on the left) and Ref.:ECOABLw applied (ambient image) LFMT120 perforation on both images..

DESCRIPTION

The ECOiso[®]ABL[®] is ideal to install in auditoriums, conference rooms, business spaces, restaurants and bars, etc.. The coconut fibre is a natural, renewable and very light vegetal material. It has high porosity (95% of pores), which translates into an extremely high absorption of sound energy. The good behaviour of the recycled wood fibres, associated with the coconut fibre's micro-porous absorbent properties, makes a natural first-class combination in terms of acoustic solutions.

The acoustic behaviour of the ECOiso[®]ABL[®] (coconut + wood) delivers a natural combination, and ensures solutions with superb acoustic performances to reduce airborne levels, as well as an excellent aesthetic and decorative integration.

The ECOiso[®]ABL[®] is composed of two materials (coconut fibres and recycled wood fibres) forming the Acoustic Absorber element, that gives us the final decorative finishing.

FEATURES

- 100% natural materials.
- 100% recycled and recyclable.
- Noise reduction coefficient (NRC): **0.78/m²**
- Fire-resistance: Wood Veneer Faced (or Engineered Coloured Fibre) Boards - Euroclass B-s2,d0 (similar to old M1), Coconut (Coir Fibre) - Euroclass E (similar to old M4).
- Unlimited durability, no loss of features.
- Excellent dimensional stability (even when subject to high thermal variations).
- Low energy consumption during the manufacturing process.

ABSORPTION COEFFICIENT



ABSORPTION COEFFICIENT: Values in accordance with the standards, EN 20654, ASTM C423 and EN 11654.

● ADDSORB LINE
 ○ LEAKY FM LINE

ENGINEERED COLOURED WOOD COLOURS

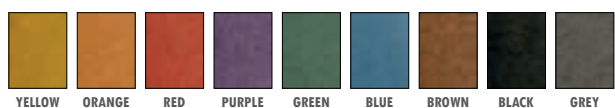

TECHNICAL DRAWINGS

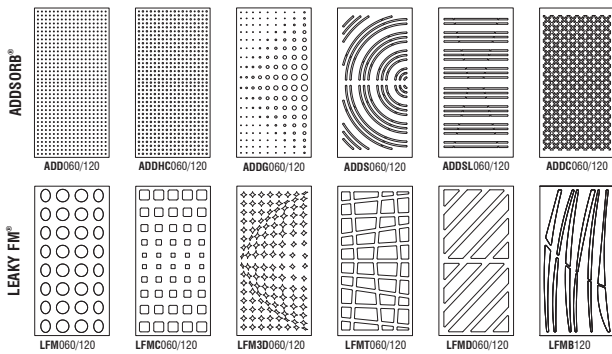

MODELS AND SIZES

MODELS	HEIGHT	WIDTH	DEPTH	WEIGHT
ECOABLc	120 cm (47.2 in)	60 cm (23.6 in)	2.8 cm (2.8 in)	4.1 Kg (9.04 lbs)
ECOABLw	120 cm (47.2 in)	60 cm (23.6 in)	2.8 cm (2.8 in)	4.1 Kg (9.04 lbs)

ABSORPTION COEFFICIENTS OF ALL MODELS (NRC) AND FINISHING PANELS PERFORATIONS (%/m²)

ADDSORB [®] REFERENCE AND SIZES AVAILABLE	PERFORATIONS (%/m ²)	NRC	LEAKY FM [®] REFERENCE AND SIZES AVAILABLE	PERFORATIONS (%/m ²)	NRC
ADD 060/120	4,53%	0,53	LFM 060/120	31,00%	0,82
ADDHC 060/120	7,36%	0,63	LFMC 060/120	12,03%	0,77
ADDG 060/120	6,22%	0,59	LFM3D 060/120	13,47%	0,72
ADDS 060/120	17,73%	0,74	LFMT 060/120	52,22%	0,90
ADDSL 060/120	18,39%	0,74	LFMD 060/120	51,31%	0,90
ADDC 060/120	20,72%	0,76	LFMB 060	38,35%	0,80

WOOD VENEER FINISHINGS



IMPORTANT NOTICES

- JOCAVI[®] accepts no responsibility for any printing errors. Specifications can be modified without prior notice, if technical or commercial reasons so require.
- The colours shown on this catalogue are only a reference and an illustration of the products finishing. The colours shown are not binding because brightness, contrast and colour balance may vary due to the printing process.
- Colours may vary due to raw-material suppliers' changes and some differences may occur in tonal range.
- Due to its natural origin, wood-based products will always present natural imperfections inherent to the organic nature. And for similar reasons, they will also present traces of old-age in the course of time.
- Wood and Fabric products are highly susceptible to change its appearance with humidity and temperature. Close attention must be paid to the storage conditions and the acclimatization before, during and after the installation.
- Typical Indoor Comfort Standards state a temperature range of 20°C - 27°C (68°F - 81°F), and a relative humidity of less than 60%. These would be considered as normal operational levels of JOCAVI[®] products' range.
- Despite all the standard sizes of all products, this model can be customised upon previous consultation. Sizes may vary slightly due to their production method and some inherent raw-materials characteristics.



ECOiso[®] SYSTEM

SOUNDPROOFING AND ABSORBENT LAYER



Image of 120x600cm model Ref.:ECOIS093 (on the left) and Ref.:ECOIS073 applied (ambient image).

DESCRIPTION

Following an ecological philosophy, JOCAVI[®] has designed this line of acoustic insulation and treatment materials, which are made exclusively from natural raw-materials, like cork and coconut. This compound, made of strictly 100% natural ecological materials, has an excellent technical performance. The unique features of these raw materials combined in the ECOiso[®] provide it with a high degree of thermal, acoustic and anti-vibration insulation and airborne noise reduction. This product represents the most practical, efficient and ecological solution to build high-quality acoustic insulation and treatment. The ECOiso[®] is ideal to install in music and television studios, business spaces, auditoriums, conference rooms, restaurants and bars, etc.

The acoustic behaviour of the ECOiso[®] (cork + coconut + wood) delivers a natural combination, and ensures solutions with superb acoustic performances to reduce sound levels, as well as an excellent aesthetical and decorative integration.

The ECOiso[®] system is composed of two types of elements in plates and some accessories. The first element to be applied is the Acoustic Insulation, and the second element is the Acoustic Absorber that gives the final decorative finishing. Accessories are: wooden slats, wall plugs, bolts and glue.

FEATURES

- Renewable, 100% natural raw-material and fully recyclable.
- Noise reduction coefficient (NRC): **0.78/m²**
- Level of sound insulation: **Rw 54 dB**.
- Fire-resistance: Wood Veneer Faced (or Engineered Coloured Fibre) Boards - Euroclass B-s2,d0 (similar to old M1), Coconut (Coir Fibre) - Euroclass E (similar to old M4) and Cork Euroclass E (similar to old M4).
- **Thermal, acoustic insulation, anti-vibration and acoustic absorbent.**
- Unlimited durability, no loss of features.
- Excellent dimensional stability (even when subject to high thermal variations).
- Low energy consumption during the manufacturing process.

SOUND INSULATION INDEX R (dB)

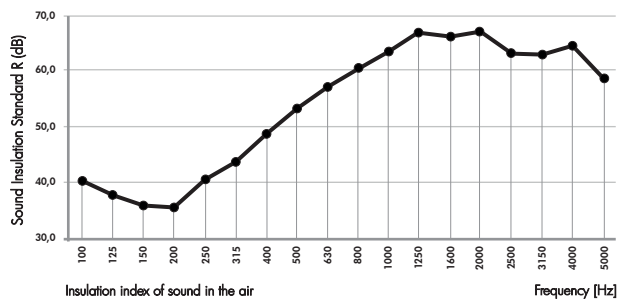

ENGINEERED COLOURED WOOD COLOURS

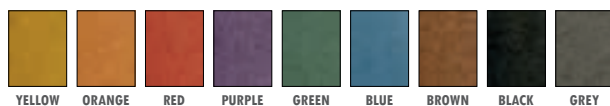

IMPORTANT NOTICES

- JOCAVI[®] accepts no responsibility for any printing errors. Specifications can be modified without prior notice, if technical or commercial reasons so require.
- The colours shown in this catalogue are only a reference and an illustration of the products finishing. The colours shown are not binding because brightness, contrast and colour balance may vary due to the printing process.
- Colours may vary due to raw-material suppliers' changes and some differences may occur in tonal range.
- Due to its natural origin, wood-based products will always present natural imperfections inherent to the organic nature. And for similar reasons, they will also present traces of old-age in the course of time.
- Wood and Fabric products are highly susceptible to change its appearance with humidity and temperature. Close attention must be paid to the storage conditions and the acclimatization before, during and after the installation.
- Typical Indoor Comfort Standards state a temperature range of 20°C - 27°C (68°F - 81°F), and a relative humidity of less than 60%. These would be considered as normal operational levels of JOCAVI[®] products' range.
- Despite all the standard sizes of all products, this model can be customised upon previous consultation. Sizes may vary slightly due to their production method and some inherent raw-materials characteristics.

TECHNICAL DRAWINGS



MODELS AND SIZES

MODELS	HEIGHT	WIDTH	DEPTH	WEIGHT
ECOIS093	120 cm (47.2 in)	60 cm (23.6 in)	9.3 cm (3.7 in)	13.6 Kg (29.98 lbs)
ECOIS073	120 cm (47.2 in)	60 cm (23.6 in)	7.3 cm (2.9 in)	12.6 Kg (27.78 lbs)

THERMAL TRANSMISSION COEFFICIENT

LAYERS	λ [W/m.°C]	e [m]	R [m ² .C/W]
Rse			0,040
traditional plaster	1,30	0,015	0,012
brick 22 Preceram	-	0,220	0,580
traditional plaster	1,30	0,015	0,012
ECO iso board	0,04	0,040	1,500
ADD or LFM finishing board	0,25	0,0125	0,050
Rsi			0,130

Thermal transmission coefficient **U = 0,430 W/m².°C** (without insulation U = 1,294 W/m².°C)

WOOD VENEER FINISHINGS



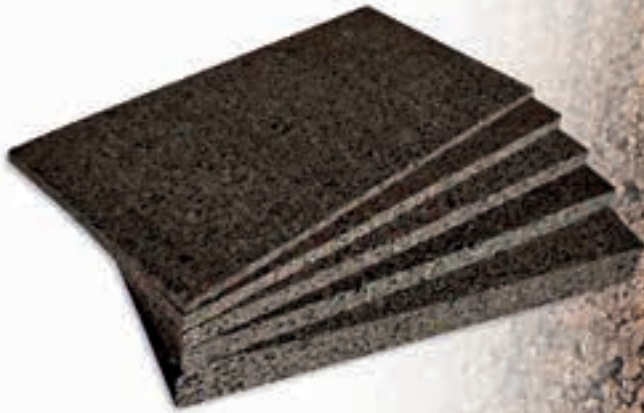

Different thickness models of SPL (on the left) and SPL applied (ambient image).

DESCRIPTION

It is definitely the oldest and noblest raw material used for Acoustic and Thermal Insulation. Cork, a 100% natural product, is par excellence the best material for soundproofing.

This agglomerate is made of selected raw material originating from self-sustainable cork-oak stands, which are more than 100 years old, in the Portuguese territory. The process to manufacture the agglomerate only uses cork and steam, no other additives. The density is controlled at 120kg/m³ - (264.55 lbs/ft³).

It comes in 1000 x 500mm plates (39.4"x19.7") and its thickness varies between 20 and 100mm (0.8"x3.9"). It may be placed on the inner layers of walls, ceilings or floors or may be placed on the outer layer as a final finishing.

This material is simply beautiful, exotic and very attractive and it may certainly make the difference in your space. Control noise like never before!

FEATURES

- 100% Cork and Natural Material
- Density: 120Kg / m³ - (264.55 lbs/ ft³).
- Fire-resistance: single product Euroclass E (similar to old M4) and ETICS system Euroclass B-s1,d0 (similar to old M1).
- Unlimited durability and excellent Thermal Properties.
- Excellent anti-vibration properties.
- Applicable on ceilings, floors and walls.
- Applicable as coating or as insulation material.
- Plate sizes: 1000x500mm (39.4"x19.7"); thickness, 10/20/40/60/80/100mm (0.4"/0.8"/1.6"/2.4"/3.1"/3.9").

SOUND INSULATION INDEX (dB/Hz)

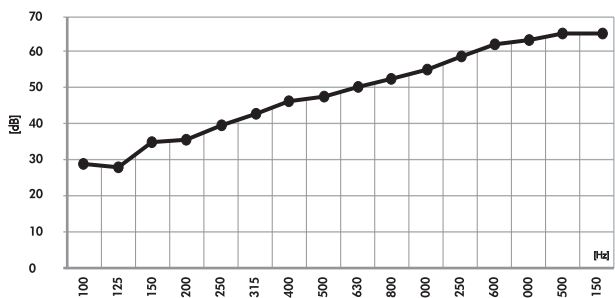

● 13mm plaster + 110mm ceramic brick + 13mm plaster + ECOiso[®] SPL[®] 60mm
0.5" plaster + 4.3" ceramic brick + 0.5" plaster + ECOiso[®] SPL[®] 60mm (2.4")

INSULATION AND THERMAL RESISTANCE VALUES

Thickness	INSULATION VALUES R_w (dB)	THERMAL RESISTANCE R_t (m ² ·°C/W)
20mm ECOiso [®] SPL [®]	$R_w = 39$ dB	0,50
40mm ECOiso [®] SPL [®]	$R_w = 44$ dB	1,00
60mm ECOiso [®] SPL [®]	$R_w = 50$ dB	1,50
80mm ECOiso [®] SPL [®]	$R_w = 52$ dB	2,00
100mm ECOiso [®] SPL [®]	$R_w = 54$ dB	2,50

IMPORTANT NOTICES

- JOCAVI[®] accepts no responsibility for any printing errors. Specifications can be modified without prior notice, if technical or commercial reasons so require.
- Colours may vary due to raw-material suppliers' changes and some differences may occur in tonal range.
- Due to its natural origin, wood-based products will always present natural imperfections inherent to the organic nature. And for similar reasons, they will also present traces of old-age in the course of time.
- Wood and Fabric products are highly susceptible to change its appearance with humidity and temperature. Close attention must be paid to the storage conditions and the acclimatization before, during and after the installation.
- Typical Indoor Comfort Standards state a temperature range of 20°C - 27°C (68°F - 81°F), and a relative humidity of less than 60%. These would be considered as normal operational levels of JOCAVI[®] products' range.

APPLICATION EXAMPLES

REINFORCEMENT INSULATION COATING

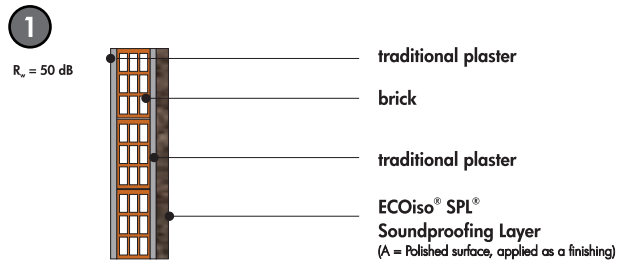

13mm plaster + 110mm ceramic brick + 13mm plaster + ECOiso[®] SPL[®]60mm
0.5" plaster + 4.3" ceramic brick + 0.5" plaster + ECOiso[®] SPL[®]60mm (2.4")

INSIDE A PARTITION WALL

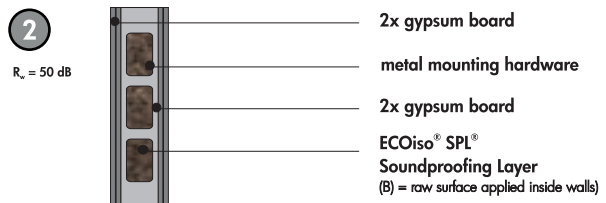

2x13mm gypsum board + ECOiso[®] SPL[®]60mm on metal frame + 2x13mm gypsum board
2x0.5" gypsum board + ECOiso[®] SPL[®]60mm (2.4") on metal frame + 2x0.5" gypsum board

GENERAL FEATURES

TECHNICAL FEATURES	STANDARD	LIMIT VALUES / TOLERANCES	CLASS
Apparent bulk density	NP EN 1602	< 130 kg/m ³	---
Thermal conductivity coefficient	EN 12667	< 0,040 W/m.K (λ _s)	---
Water content	EN 12105	< 8%	---
Water absorption	NP EN 1609	< 0,5 kg/m ²	WS
Fire Class	NP ISO 11925-1	< 150 mm (h)	Euroclass E
	ETICS	---	B - s1,d0

INSULATION AND THERMAL RESISTANCE VALUES

Thickness	INSULATION VALUES R_w (dB)	THERMAL RESISTANCE R_t (m ² ·°C/W)
40mm ECOiso [®] SPL [®]	$R_w = 44$ dB	1,00
60mm ECOiso [®] SPL [®]	$R_w = 50$ dB	1,50
80mm ECOiso [®] SPL [®]	$R_w = 53$ dB	2,00
100mm ECOiso [®] SPL [®]	$R_w = 56$ dB	2,50

(1) Laboratory Measurement of Sound Absorption Coefficient according to ISO 140-3 and ISO 354:2003



GROUTPAINT®

ACOUSTIC FINISHING COMPOUND

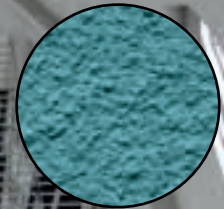

TEXTURE AND COLOUR EXAMPLE



EXAMPLE OF APPLICATION

DESCRIPTION

GROUTPAINT® is a water-based acoustic anti-vibration adhesive paint. Different from the conventional damping materials, GROUTPAINT® is a low-density product, which has a high damping performance on the premise of its low weight.

The product is a key choice to reduce air noise and reverberation time, ideal for use on large surfaces for environments with strict additional weight requirements, such as plasterboard and concrete surfaces, constructions structures and building ceilings, yachts, vehicles and trains, etc. It provides a quick drying performance, environment-protection, performance and fire resistance. GROUTPAINT® is a 95% recycled compound.

This product can be applied on almost all surfaces by spraying, either using a pressure tank spray machine or an endless screw spray machine system gun.

GROUTPAINT® should be diluted with water (10%). It is advisable to apply a thin coat of (800g/ sq.m) as a primer to enhance adherence and to let it dry out completely before the next coat is sprayed. After that, you can apply more 2 or 3 coats, reaching 15mm maximum thickness.

The product effectively reduces the reverberation time, the resonance effect and the transmission loss is increased. Obviously it controls the resonant frequency of the raw base material, caused by micro vibrations, improving the noise reduction rate.

RECOMMENDATIONS AND FEATURES

- 10Kg bucket (22.05 Lbs), Water-based, easy to use and clean, 95% recycled compound.
- Main composition: Cellulose, textile and inert mineral fillers.
- Fire Class: A2-s1,d0, Non-Flammable (similar to old M0, French Norms CSTB).
- Absorption coefficient: 0.41/m² 12 to 15mm thickness (0.5" to 0.6").
- Application: any pressure tank spray machine or an endless screw spray machine using a large nozzle, from 8 to 12 mm (0.8" to 0.5").
- GROUTPAINT® should be diluted with water (10%). It is important to keep the same dilution during the whole job in order to ensure a continuous final look. DO NOT FORGET to add the small bottle of additive before application with an electrical mixer. This additive increases air entrainment and facilitates spraying application.

- GROUTPAINT® is fully compatible with all concentrated aqueous Paints used as colorants. Add the dye in the mix with an electrical mixer and make the color test before applying.
- Coverage: 4kg/m² (8.82 lbs/10.76 ft²) = 5mm to 12 Kg/m² (0.2" to 26.46 lbs/10.76 ft²) = depending on required sound absorption.
- Productivity: 0.8 to 1,2 Kg / m² (1.76 to 2.65 lbs/10.76 ft²) depending on the desired effect and the type of support. Drying: 24 to 36 hours (allow enough ventilation)
- Maximum thickness per layer: 5mm (0.2").
- Excellent adhesive ability to all surfaces. Suitable for indoor use only.
- The product follows IMO A653 standard and CE certification (MED B) and reaches the quality requirements of BS476.6 and BS476.7.
- Storage: 6 months in original package if not opened. Keep away from intensive heat and frost.

ABSORPTION COEFFICIENT

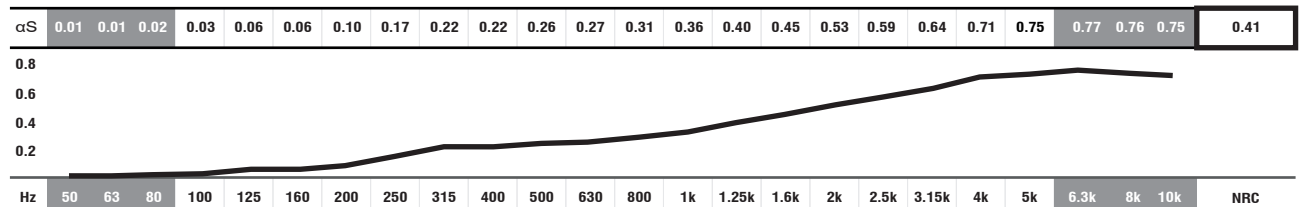

■ ABSORPTION COEFFICIENT: Values in accordance with the standards: EN 20654, ASTM C423 and EN 11654.

■ Values [$< 100\text{Hz}$ and $> 5\text{K}$] are Non Standard Values.

APPLICATION METHODS



IMPORTANT NOTICES

- JOCAVI® accepts no responsibility for any printing errors. Specifications can be modified without prior notice, if technical or commercial reasons so require.
- The colours shown in this catalogue are only a reference and an illustration of the products finishing. The colours shown are not binding because brightness, contrast and colour balance may vary due to the printing process.
- Colours may vary due to raw-material suppliers' changes and some differences may occur in tonal range. Sizes may vary slightly due to their production method and some inherent raw-materials characteristics.



ECOiso[®] NCF

NOISE CONTROL FLOOR



Image of NCF single unit (on the left) and NCF applied (ambient image).

DESCRIPTION

ECOiso[®]NCF[®] is a sound insulation material composed by one sheet of Cork Agglomerate and one board of high-density recycled wood fibers. This material was thought in order to reduce transmission of sound and vibration in the floors of residential and commercial buildings. It can also be used on walls and ceilings.

The strength and durability added to the available dimensions of the ECOiso[®]NCF[®] make it ideally suitable for primary construction or retrofitting of existing applications. There is requirement for a sound insulation material that should be as thin as possible, in order to maximize the usable room areas.

Beforetime the use of cork and wood agglomerates was one of earliest methods for building studios soundproofing insulation. It was soon discovered that these same excellent characteristics so essential in recording studios, could be applied equally well to home theatres, home studios, music rooms and many others.

ECOiso[®]NCF[®] has also proven effective over a wide sound frequencies range, giving the best noise reduction values at the low and high-frequencies in a single composite material.

FEATURES

- 100% Recyclable and Natural raw-materials.
- Recycled raw-materials.
- Fire-resistance: OSB - Euroclass D-s1,d0 (similar to old M3) and Cork - Euroclass E (similar to old M4).
- Supplied in tiles, easy to install.
- Excellent anti-vibrate performance.
- Easily cut to adjust to room dimensions.
- Provided in two sizes: **50 X 50 cm** or **100 X 50 cm** (19.7" x 19.7" or 39.4" x 19.7").
- Suitable for primary construction or retrofitting.

AIRBORN SOUND INSULATION (dB/Hz)

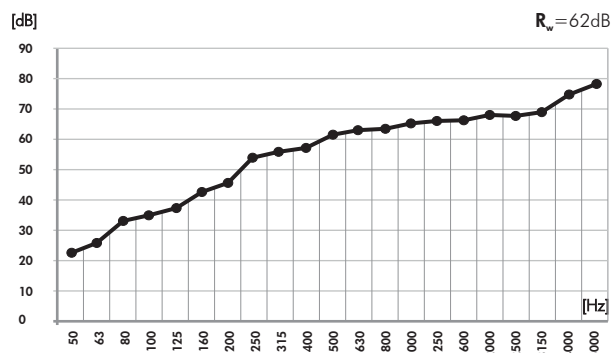

PACKAGE INFORMATION of 50 x 50 cm tiles

REFERENCE	PACKAGE DIMENSIONS	NR. OF TILES PER BOX
ECOiso [®] NCF486 - 60mm	1 Box - 62 x 62 x 36 cm	6 tiles (2,88m ²)
ECOiso [®] NCF488 - 80mm	1 Box - 62 x 62 x 36 cm	4 tiles (1,92m ²)

APPLICATION EXAMPLE

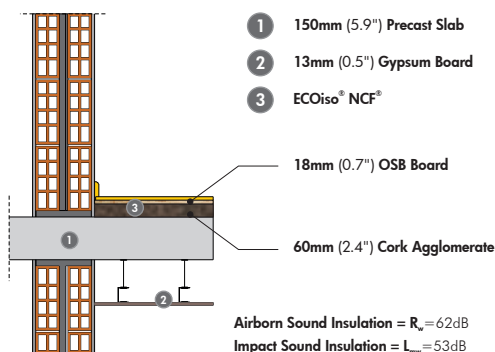

MODELS AND SIZES

MODELS	HEIGHT	WIDTH	DEPTH	WEIGHT
ECONCF968	100 cm (39.4 in)	50 cm (19.7 in)	8 cm (3.1 in)	8.2 Kg (18.08 lbs)
ECONCF966	100 cm (39.4 in)	50 cm (19.7 in)	6 cm (2.4 in)	7.4 Kg (16.31 lbs)
ECONCF488	50 cm (19.7 in)	50 cm (19.7 in)	8 cm (3.1 in)	4.1 Kg (9.04 lbs)
ECONCF486	50 cm (19.7 in)	50 cm (19.7 in)	6 cm (2.4 in)	3.7 Kg (8.16 lbs)

IMPACT SOUND INSULATION (dB/Hz)

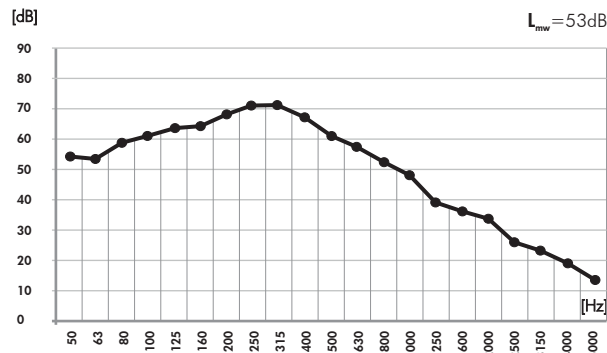

PACKAGE INFORMATION of 100 x 50 cm tiles

REFERENCE	PACKAGE DIMENSIONS	NR. OF TILES PER BOX
ECOiso [®] NCF966 - 60mm	1 Box - 120 x 62 x 36 cm	6 tiles (5,76m ²)
ECOiso [®] NCF968 - 80mm	1 Box - 120 x 62 x 36 cm	4 tiles (3,84m ²)

IMPORTANT NOTICES

- JOCAVI[®] accepts no responsibility for any printing errors. Specifications can be modified without prior notice, if technical or commercial reasons so require.
- The colours shown on this catalogue are only a reference and an illustration of the products finishing. The colours shown are not binding because brightness, contrast and colour balance may vary due to the printing process.
- Due to its natural origin, wood-based products will always present natural imperfections inherent to the organic nature. And for similar reasons, they will also present traces of old-age in the course of time.
- Wood and Fabric products are highly susceptible to change its appearance with humidity and temperature. Close attention must be paid to the storage conditions and the acclimatization before, during and after the installation.
- Typical Indoor Comfort Standards state a temperature range of 20°C - 27°C (68°F - 81°F), and a relative humidity of less than 60%. These would be considered as normal operational levels of JOCAVI[®] products' range.
- Despite all the standard sizes of all products, this model can be customised upon previous consultation. Sizes may vary slightly due to their production method and some inherent raw-materials characteristics.



QUADCORK®

ABSORBENT PANEL



Image of 25x25x6cm model Ref.:QCK006 (on the left) and Ref.:QCK006 models applied (ambient image).

DESCRIPTION

Following an ecological philosophy, JOCAVI® has designed this product made exclusively of cork from cork oak trees. Its industrial process is 100% natural. The QUADCORK® is an anti-vibration insulation and acoustic treatment product with a high degree of thermal insulation as well. The outstanding behaviour of the Expanded Cork Agglomerate, in terms of insulation and dimensional elasticity and its controlled porosity and density, delivers excellent acoustic performances to reduce sound levels by structure-born transmission and to reduce airborne noise and reverberation time. The QUADCORK® is thus the practical, efficient and ecological solution for a good acoustic insulation and treatment. It is meant to be applied on continuous surfaces or on selected spots. It comes in 25cm x 25cm (9.8" x 9.8") mosaics that are simply glued to the surfaces, walls and ceilings. The QUADCORK® is simply made of cork as its raw-material, without additives..., and is bonded with its own resin. 90% of the energy consumption is made up of biomass, the waste of its industrial process, granules and dust. It is fully reusable.

FEATURES

- Renewable and 100% natural raw-material and fully recyclable.
- NRC: **0.42/m²** - 4cm (1.6") and **0.53/m²** - 6cm (2.4").
- Level of sound insulation: **Rw 52 dB**.
- Fire resistance: Euroclass E (EN 13501-1 - similar to old M4). No release of toxic gases.
- Thermal, acoustic and anti-vibration insulation material.
- Density: 120Kg / m³ - (264.55 lbs/ ft³).
- Thermal conductivity / Specific heat: 0.004W/mk.
- Natural industrial process (without additives).
- Unlimited durability, no loss of features.

ABSORPTION COEFFICIENT*

αS	0.01	0.03	0.05	0.06	0.07	0.07	0.08	0.09	0.10	0.18	0.28	0.48	0.84	0.83	0.55	0.44	0.47	0.58	0.69	0.62	0.59	0.61	0.62	0.58	0.42
αS	0.02	0.05	0.08	0.07	0.07	0.09	0.12	0.19	0.33	0.57	0.78	0.85	0.79	0.61	0.53	0.49	0.54	0.61	0.69	0.63	0.59	0.62	0.63	0.59	0.53

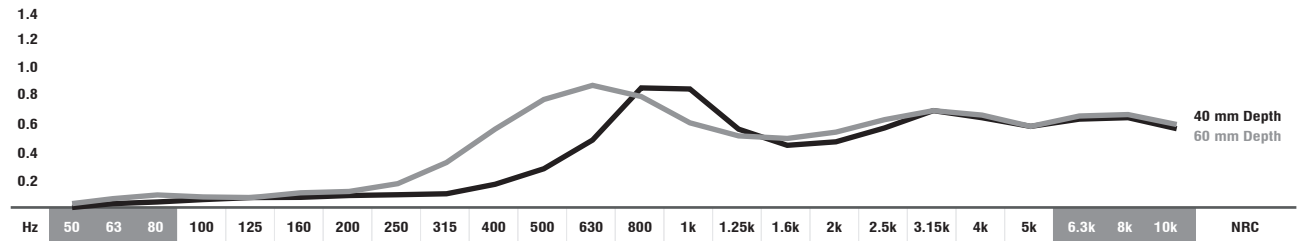

■ ■ ABSORPTION COEFFICIENT: Values in accordance with the standards: EN 20654, ASTM C423 and EN 11654.

■ Values [$< 100\text{Hz}$ and $> 5\text{K}$] are Non Standard Values.

*PANEL DATA ONLY OF REF: QCK004 AND QCK006 MODELS.

STANDARD CORK COLOUR

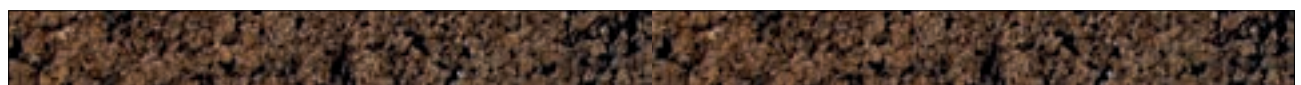

IMPORTANT NOTICES

- JOCAVI® accepts no responsibility for any printing errors. Specifications can be modified without prior notice, if technical or commercial reasons so require.
- The colours shown on this catalogue are only a reference and an illustration of the products finishing. The colours shown are not binding because brightness, contrast and colour balance may vary due to the printing process.
- Colours may vary due to raw-material suppliers' changes and some differences may occur in tonal range.
- Due to its natural origin, wood-based products will always present natural imperfections inherent to the organic nature. And for similar reasons, they will also present traces of old-age in the course of time.
- Typical Indoor Comfort Standards state a temperature range of 20°C - 27°C (68°F - 81°F), and a relative humidity of less than 60%. These would be considered as normal operational levels of JOCAVI® products' range.
- Despite all the standard sizes of all products, this model can be customised upon previous consultation. Sizes may vary slightly due to their production method and some inherent raw-materials characteristics.

TECHNICAL DRAWINGS

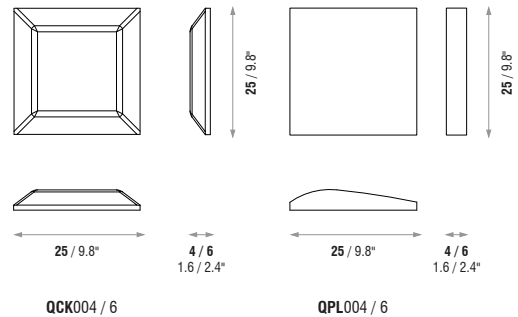

MODELS AND SIZES

MODELS	HEIGHT	WIDTH	DEPTH	WEIGHT
*QCK006	25 cm (9.8 in)	25 cm (9.8 in)	6 cm (2.4 in)	0.5 Kg (1.10 lbs)
**QCK004	25 cm (9.8 in)	25 cm (9.8 in)	4 cm (1.6 in)	0.3 Kg (0.66 lbs)
*QPL006	25 cm (9.8 in)	25 cm (9.8 in)	6 cm (2.4 in)	0.5 Kg (1.10 lbs)
**QPL004	25 cm (9.8 in)	25 cm (9.8 in)	4 cm (1.6 in)	0.3 Kg (0.66 lbs)

SOLD IN BOXES *1 Box = 0.75m² / **1 Box = 1.225m²

SOLD IN BOXES *1 Box = 8.07ft² / **1 Box = 12.1ft²



BASMEL[®] ACOUSTIC CURTAIN

ABSORBENT PANEL



Image of 600x150cm model Ref.:BAC1506 and the model 800x150cm Ref.:BAC1508 applied (ambient image).

DESCRIPTION

BASMEL[®] Acoustic Curtain is a low-cost acoustic product to be applied as a curtain or a sound divider. It is made of flexible open-cell polyester foam coated with fabric on both sides by fire-resistant fabric-finishing. At each end of the roll has fastening points for simple application.

This product can be applied as a window curtain or as a separator between different zones. The sound waves penetrate the open-cell structure, thus reducing the reflected energy and giving this product an excellent sound absorption capacity.

This product can be customized according to the specifications of each project, various colors and sizes can be provided by prior consultation.

TECHNICAL DRAWINGS

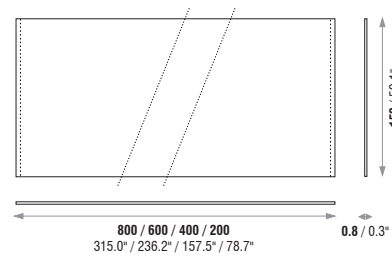

FEATURES

- NRC: **0.34/m²**.
- Fire-resistance: Germany B1, France M1, GB Class 1, USA V0 / HF1 .
- BASMEL[®] Acoustic Curtains are provided in rolls to be suspended.
- Mobile solution for events or to be permanently installed.
- Improves sound's intelligibility and sound insulation between different adjacent performing spaces.
- Easily assembled and adaptable to the audience capacity of each event.
- Can be used as a curtain or as a sound divider.
- Raw materials: Acoustic Foam and Fabric.

MODELS AND SIZES

MODELS	HEIGHT	WIDTH	DEPTH	WEIGHT
BAC1508	800 cm (315.0 in)	150 cm (59.1 in)	0.8 cm (0.3 in)	28 Kg (61.73 lbs)
BAC1506	600 cm (236.2 in)	150 cm (59.1 in)	0.8 cm (0.3 in)	21 Kg (46.30 lbs)
BAC1504	400 cm (157.5 in)	150 cm (59.1 in)	0.8 cm (0.3 in)	14 Kg (30.86 lbs)
BAC1502	200 cm (78.7 in)	150 cm (59.1 in)	0.8 cm (0.3 in)	7 Kg (15.43 lbs)

ABSORPTION COEFFICIENT

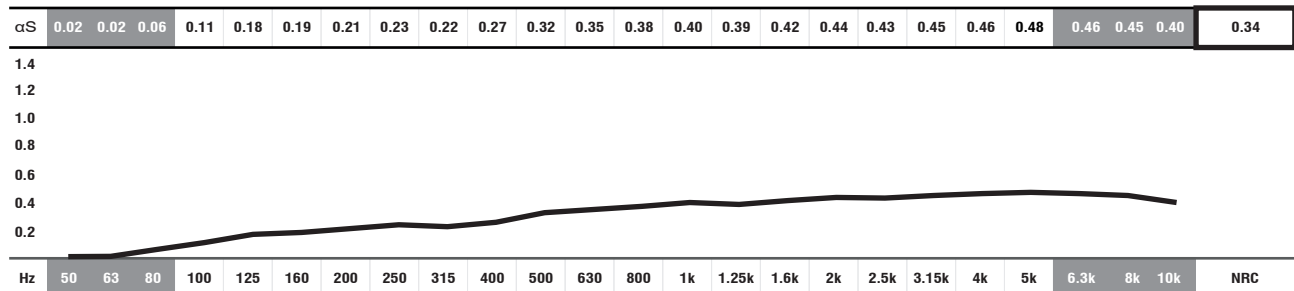

■ ABSORPTION COEFFICIENT: Values in accordance with the standards: EN 20654, ASTM C423 and EN 11654.

■ Values [$< 100\text{Hz}$ and $> 5\text{K}$] are Non Standard Values.

STANDARD FABRIC COLOURS / (Other customized colours available on demand)



IMPORTANT NOTICES

- JOCAVI[®] accepts no responsibility for any printing errors. Specifications can be modified without prior notice, if technical or commercial reasons so require.
- The colours shown on this catalogue are only a reference and an illustration of the products finishing. The colours shown are not binding because brightness, contrast and colour balance may vary due to the printing process.
- Colours may vary due to raw-material suppliers' changes and some differences may occur in tonal range. Close attention must be paid to the storage conditions and the acclimatization before, during and after the installation.
- Typical Indoor Comfort Standards state a temperature range of 20°C - 27°C (68°F - 81°F), and a relative humidity of less than 60%. These would be considered as normal operational levels of JOCAVI[®] products' range.
- Despite all the standard sizes of all products, this model can be customised upon previous consultation. Sizes may vary slightly due to their production method and some inherent raw-materials characteristics.



ARG®

RECYCLED SOUND INSULATION FOAM AGGLOMERATE

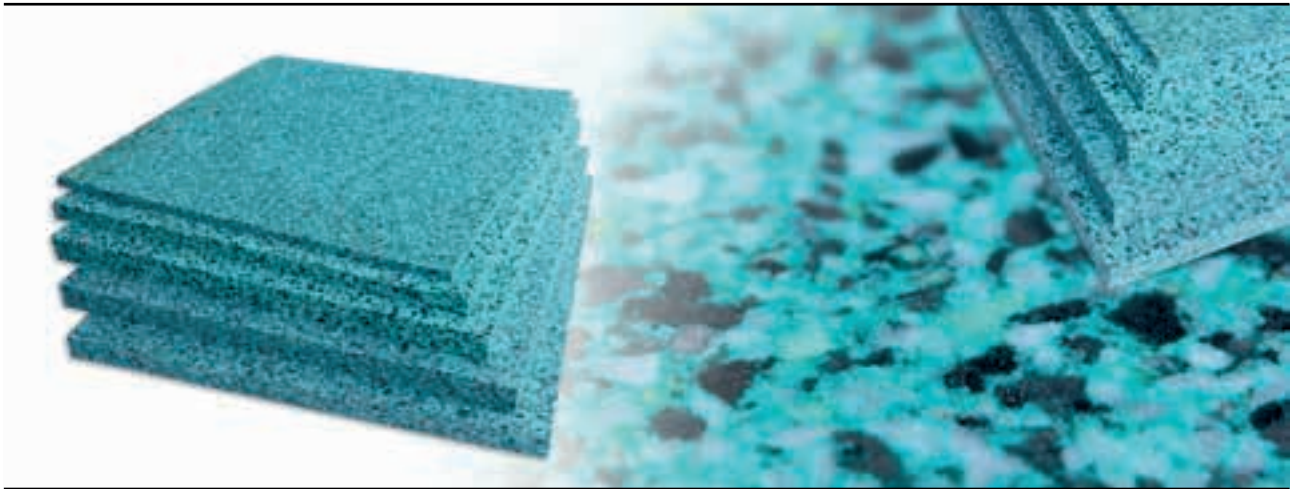

Image of ARG with different thickness, Ref.:ARG.

FEATURES

- Self-extinguishable recycled foam agglomerate.
- Made from the agglomeration of flexible polyurethane foam of different densities.
- Good fire resistance (M1 fire-class), uniform and stable composition.
- Great performance/cost. Supplied in 1m² (10.76 ft²) plates.
- Installation: with contact glue.
- Wide range of thickness, from 2 cm to 10 cm (0.8" to 3.9") with 80Kg/m³. (others upon consulting and request).
- Suitable for walls, ceilings and floors.

SPECIFICATIONS

REF.	DIMENSIONS	WEIGHTS
ARG020	100 x 100 x 2 cm / (39.4 x 39.4 x 0.8 in)	1.6 Kg (3.527 lbs)
ARG040	100 x 100 x 4 cm / (39.4 x 39.4 x 1.6 in)	3.2 Kg (7.055 lbs)
ARG060	100 x 100 x 6 cm / (39.4 x 39.4 x 2.4 in)	4.8 Kg (10.580 lbs)
ARG080	100 x 100 x 8 cm / (39.4 x 39.4 x 3.1 in)	6.4 Kg (14.110 lbs)
ARG100	100 x 100 x 10 cm / (39.4 x 39.4 x 3.9 in)	8 Kg (17.640 lbs)

DESCRIPTION

ARG® is a product resulting from the agglomeration of flexible polyurethane foam of different densities, presented on plates, which shows a uniform and stable composition. Endowed with a porous cellular structure and unique physical and mechanical characteristics, ARG® constitutes a central element in various building systems that allow solving the most complex acoustic problems of buildings, structures, machinery and the like. Find wide application in insulation systems percussion sounds, an area where leads, allowing the development of highly competitive solutions in terms of cost / benefit ratio. It is virtually universal in its application in double construction systems (or trucks) to meet the requirement of insulation to air sounds. This field is particularly important for systems "box-in-box" particularly when necessary for rehabilitation of buildings. Other uses the level of vibration control equipment to support and reverberation control in closed spaces complete range of applications in the acoustic behavior of buildings. ARG® thus exhibits a substantially unique feature of being useful at all required in the field of acoustic behavior of buildings. This universal characteristic in the field of acoustics allows you to stand out among the products for the building, like the one in the acoustic field can contribute more for the comfort of human beings. When coupled with plaster sheets or clusters give large amounts of insulation in the whole range of the sound spectrum. Gives a high absorption power. Because it is glued, without physical contact of rigid structures, mitigation damping is achieved by means of elasticity. Acoustic Insulation above 60 dB, one must isolate all areas of walls, ceilings and floors avoiding structural physical transmissions.



SHOCK AB® WALL / CEILING

WALL AND CEILING VIBRATION ABSORBERS

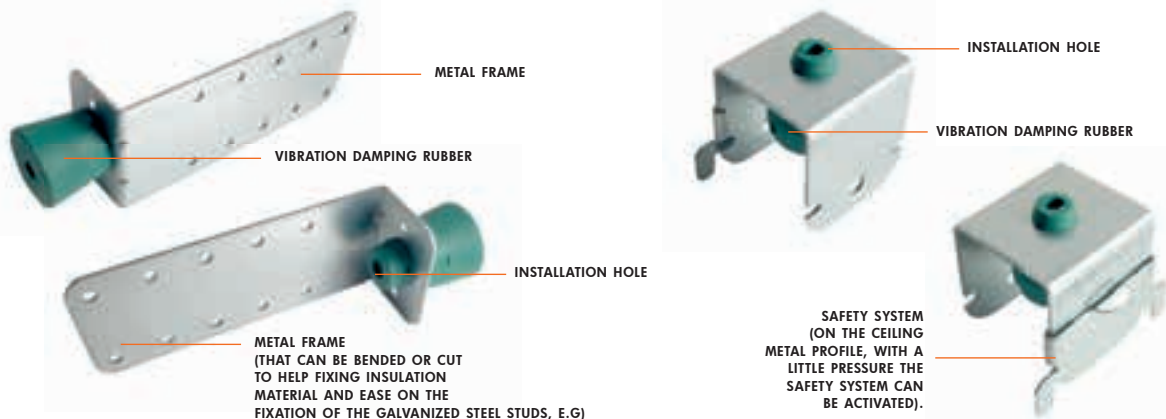

Image of SHOCK AB WALL®, Ref.:SHAW, and of SHOCK AB CEILING®, Ref.:SHAC.

FEATURES

- Dramatically improves the performance of your soundproofing layer.
- Minimise physical and structure sound transmission.
- Operating range of 30Kg to 50Kg per piece. Application: using screws.
- Can be applied in standard steel profiles used in the construction with plasterboard.
- Quick and easy installation with Safety System (SHAWC model).
- Packaging: 20 pieces.

MODELS AND SPECIFICATIONS

MODELS	MAXIMUM LOAD CAPACITY RANGE (unit)	PACKAGE (units)
SHAC	30 Kg to 50 Kg	20 pcs
SHAW	30 Kg to 50 Kg	20 pcs

DESCRIPTION

SHOCK AB® is a wall and ceiling vibration absorber, a composite piece consisting of a molded metal frame and a damping rubber component, which allows to support the weight of the wall or ceiling, thereby minimizing physical contact to the support structure and forming the sound insulation layer between the sound wave irradiation and the original base surface, wall or ceiling.

The SHOCK AB® is provided in two models; one for the ceiling and one for the wall.

SHOCK AB® Ceiling is an effective way to cut off the structure-borne sound transmission of the suspended ceiling and the original building base.

SHOCK AB® Wall is suitable for installing and fixing the wall reinforced sound insulation layer structure.

The quantity of pieces to be used on each application depends on the weight of the insulation layer that will be applied, so it is recommended make the calculation, bearing in mind that it is considered an operating range of 30kg to 50kg per piece (fixation point).

IMPORTANT NOTICES

- JOCAVI® accepts no responsibility for any printing errors. Specifications can be modified without prior notice, if technical or commercial reasons so require.
- The colours shown on this catalogue are only a reference and an illustration of the products finishing. The colours shown are not binding because brightness, contrast and colour balance may vary due to the printing process.
- Colours may vary due to raw-material suppliers' changes and some differences may occur in tonal range. Sizes may vary slightly due to their production method and some inherent raw-materials characteristics.



FLOATSHEET® INS

SOUND INSULATION LAYER



FLOATSHEET® INS ROLL



FLOATSHEET® INS PLATE

Image of FLOATSHEET® INS ROLL, Ref.:FINr010AD (on the left) and PLATE, Ref.:FINp010AD (on the right).

FEATURES

- Noise and sound Insulation layer.
- Good fire resistance, elasticity, flexibility and tensile strength.
- Great performance/cost.
- Installation: with nails or adhesive glue.
- Supplied in rolls or plates, with or without adhesive.
- Suitable for walls, ceilings and floors.

SIZES AND SPECIFICATIONS

MODELS	LENGTH	WIDTH	THICKNESS	WEIGHT
FINr010/AD (roll)	1000 cm (393.7 in)	150 cm (59.1 in)	1 cm (0.4 in)	4.62 Kg (10.19 lbs)
FINp010/AD (plate)	200 cm (78.7 in)	120 cm (47.2 in)	1 cm (0.4 in)	1.3 Kg (2.87 lbs)

DESCRIPTION

The Floatsheet® INSulation is made of polyurethane and it is a great material to be used as an insulation layer. The application of Floatsheet® INSulation meets the active sound insulation. It is suitable for use on the sound insulation composite constructions in studios, cabins, residences, hotels, clubs, nightclubs, as well as for industrial and traffic equipment.

Floatsheet® INSulation can effectively absorb and obstruct the noise transmitted through the walls, ceilings and floor structures by utilizing the mass law and damping principle of the architectural acoustic materials.

This thin and high quality material can provide obvious noise control and vibration absorption resulting in a highest cost/performance. It has good fire resistance, heat resistance, elasticity, flexibility and tensile strength. It can be cut with the wallpaper cutter and be fixed with nails or adhesive. This material is supplied in two options: rolls or plates.



FLOATSHEET® VIB

VIBRATION DAMPING AND SOUND INSULATION LAYER



FLOATSHEET® VIB AD

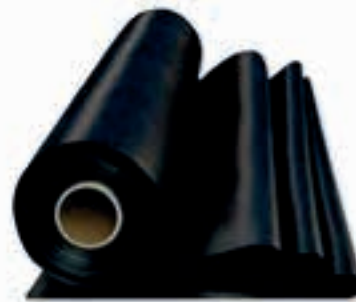

FLOATSHEET® VIB

Image of FLOATSHEET® VIB, Ref.:FVI003AD (with adhesive on the left), and FLOATSHEET® VIB, Ref.:FVI003 (on the right).

FEATURES

- Anti-vibration and noise control layer with great mass.
- Good fire resistance, elasticity, flexibility and tensile strength.
- Great performance/cost.
- Installation: with nails or adhesive glue.
- Supplied in rolls with or without adhesive.
- Suitable for walls, ceilings and floors.

SIZES AND SPECIFICATIONS

MODELS	LENGTH	WIDTH	THICKNESS	WEIGHT
FVI003AD	500 cm (196.85 in)	100 cm (39.4 in)	0.3 cm (0.1 in)	18.85 Kg (41.56 lbs)
FVI003	500 cm (196.85 in)	100 cm (39.4 in)	0.3 cm (0.1 in)	18.85 Kg (41.56 lbs)

DESCRIPTION

Floatsheet® VIBration, is a composed material made of a mixture of tar and rubber. It is a great product to be used as an anti-vibration layer, suitable to be applied on the sound insulation composite construction in residences, hotels, clubs, nightclubs, recording studios, as well as for sound insulation and noise reduction of the industrial traffic equipment. This thin and high quality material provides obvious noise control and vibration absorption results in a highest cost/performance.

Floatsheet® VIBration can effectively absorb and obstruct the noise transmitted through the walls, ceilings and floor structures by utilizing the mass law and damping principle of the architectural acoustic materials.

This product has good fire resistance, heat resistance, elasticity, flexibility and tensile strength. It can be cut with the wallpaper cutter and be fixed with nails or adhesive. This material is supplied in roll in two options: with or without adhesive.

IMPORTANT NOTICES

- JOCAVI® accepts no responsibility for any printing errors. Specifications can be modified without prior notice, if technical or commercial reasons so require.
- The colours shown on this catalogue are only a reference and an illustration of the products finishing. The colours shown are not binding because brightness, contrast and colour balance may vary due to the printing process.
- Colours may vary due to raw-material suppliers' changes and some differences may occur in tonal range. Sizes may vary slightly due to their production method and some inherent raw-materials characteristics.



STILLNESS I[®]

SOUNDPROOFING PLATES



SOUNDPROOFING ENHANCEMENT
BETWEEN 13 AND 15 dB.



Image of STILLNESS I, Ref.:STLLI, Soundproofing Plates of two layers

FEATURES

- Depending on the constitution of the base of the wall or ceiling, this material can enhance the sound insulation between **13** and **15** db.
- Reduces sound transmission loss property.
- Installation: with screws or contact glue.
- Fire-resistance: B-s1,d0 (similar to M1).
- Environmentally friendly material.
- High-density board surface, paintable.
- Suitable for usage in large construction areas.
- Total thickness: 2.6 cm (1 0/1").
- The fact that it uses layers of Type X FR Gypsumboard and cement fibre board, enables its usage in construction as a fire barrier.

SIZES AND SPECIFICATIONS

MODELS	HEIGHT	WIDTH	DEPTH	WEIGHT
STLL I	244 cm (8' 0 0/1")	120 cm (3' 11 1/4")	2.6 cm (1 0/1")	25.96 Kg (57.22 lbs)

WALL APPLICATION

INSIDE A
PARTITION WALL

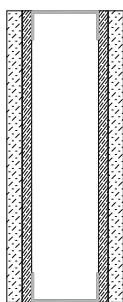

REINFORCEMENT
INSULATION COATING

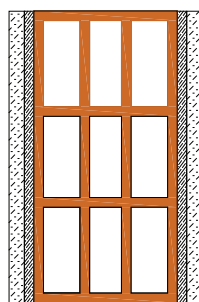

DESCRIPTION

STILLNESS is a damping system and sound insulation board composed of anti-vibration and massive elements. We've selected inorganic materials with different densities and thicknesses to form a composite layer with the best properties of sound insulation and vibration damping in order to effectively insulate the medium-low and low frequencies of the sound transmission. STILLNESS I is composed of a dual layer system made of high quality type X FR gypsum board and our 10 mm FLOATSHEET INS, when paired they can enhance the sound insulation between 13 and 15 dB, depending on the construction of the base of the wall or ceiling. This our base and most compact model. The layers of each compound model are pressed and adhered under high pressure. These composite vibration damping and sound insulation boards are much more practical than the traditional layer-by-layer construction and provides an effective sound reduction rate of walls and ceilings in all types of applications, from the music business to the industrial market. This multi-layer structure is portable and simple to install by using screws or contact glue and it is easy to cut to adjust to the room dimensions.

COMPOSITION

- STILLNESS® I is composed by:
- 1 layer of (10mm | 2/5") Polyurethane - Floatsheet® INS,
 - 1 layer of (16mm | 5/8") Type X FR Gypsumboard,

DIMENSIONS

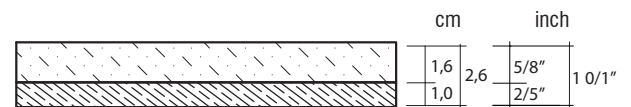

CEILING APPLICATION

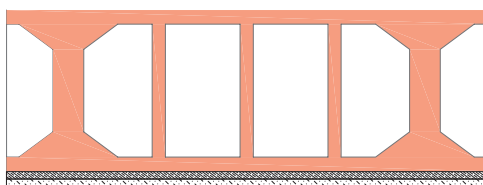

COMPOSITION



NOTICE

- JOCAVI® accepts no responsibility for any printing errors. Specifications can be modified without prior notice, if technical or commercial reasons so require.
- The colours shown on this catalogue are only a reference and an illustration of the products finishing. The colours shown are not binding because brightness, contrast and colour balance may vary due to the printing process.
- Colours may vary due to raw-material suppliers' changes and some differences may occur in tonal range. Sizes may vary slightly due to their production method and some inherent raw-materials characteristics.



STILLNESS II[®]

SOUNDPROOFING PLATES



SOUNDPROOFING ENHANCEMENT
BETWEEN 15 AND 18 dB.



Image of STILLNESS II, Ref.:STLLII, Soundproofing Plates of three layers

FEATURES

- Depending on the constitution of the base of the wall or ceiling, this material can enhance the sound insulation between **15** and **18** db.
- Reduces sound transmission loss property.
- Installation: with screws or contact glue.
- Fire-resistance: B-s1,d0 (similar to M1).
- Environmentally friendly material.
- High-density board surface, paintable.
- Suitable for usage in large construction areas.
- Total thickness: 4,2 cm (1 2/3").
- The fact that it uses layers of Type X FR Gypsumboard and cement fibre board, enables its usage in construction as a fire barrier.

SIZES AND SPECIFICATIONS

MODELS	HEIGHT	WIDTH	DEPTH	WEIGHT
STLLII	244 cm (8' 0 0/1")	120 cm (3' 11 1/4")	4.2 cm (1 2/3")	54.6 Kg (120.36 lbs)

WALL APPLICATION

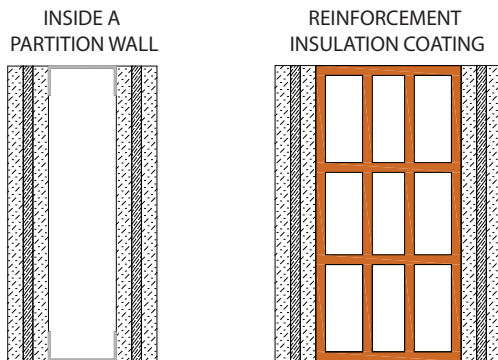

CEILING APPLICATION

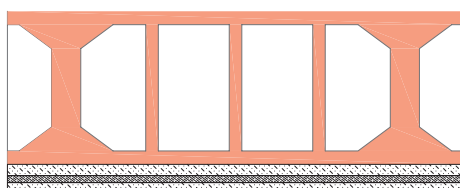

DESCRIPTION

STILLNESS is a damping system and sound insulation board composed of anti-vibration and massive elements. We've selected inorganic materials with different densities and thicknesses to form a composite layer with the best properties of sound insulation and vibration damping in order to effectively insulate the medium-low and low frequencies of the sound transmission. STILLNESS II is composed of a triple layer system built off the STLL I. Using our 10 mm FLOATSHEET INS sandwiched in between two sheets of high quality type X FR gypsum board, when combined they can enhance the sound insulation between 15 and 18 dB, depending on the construction of the base of the wall or ceiling. This model steps up and is both sturdy while still compact. The layers of each compound model are sandwiched and adhere under high pressure. These composite vibration damping and sound insulation boards are much more practical than the traditional layer-by-layer construction and provides an effective sound reduction rate of walls and ceilings in all types of applications, from the music business to the industrial market.

COMPOSITION

- STILLNESS® II is composed by:
- 1 layer of (16mm | 5/8") Type X FR Gypsumboard,
 - 1 layer of (10mm | 2/5") Polyurethane - Floatsheet® INS,
 - 1 layer of (16mm | 5/8") Type X FR Gypsumboard,

DIMENSIONS

cm		inch	
1,6	4,2	5/8"	1 2/3"
1,0		2/5"	
1,6		5/8"	

COMPOSITION

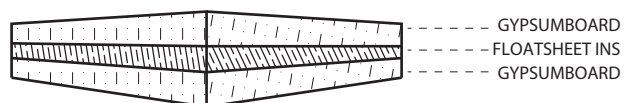

NOTICE

- JOCAVI® accepts no responsibility for any printing errors. Specifications can be modified without prior notice, if technical or commercial reasons so require.
- The colours shown on this catalogue are only a reference and an illustration of the products finishing. The colours shown are not binding because brightness, contrast and colour balance may vary due to the printing process.
- Colours may vary due to raw-material suppliers' changes and some differences may occur in tonal range. Sizes may vary slightly due to their production method and some inherent raw-materials characteristics.



STILLNESS III[®]

SOUNDPROOFING PLATES

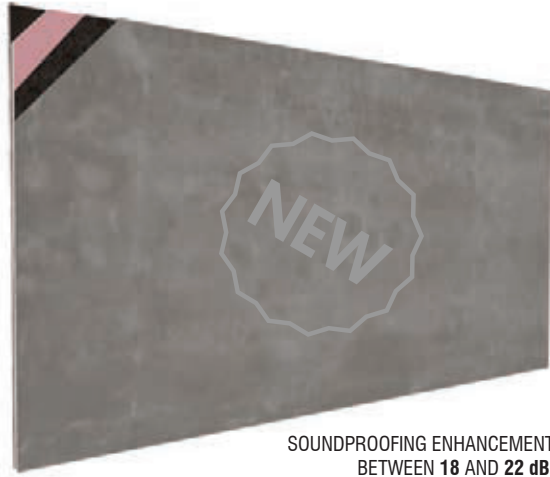

SOUNDPROOFING ENHANCEMENT BETWEEN 18 AND 22 dB.



Image of STILLNESS III, Ref.:STLLIII, Soundproofing Plates of four layers

FEATURES

- Depending on the constitution of the base of the wall or ceiling, this material can enhance the sound insulation between **18** and **22** db.
- Reduces sound transmission loss property.
- Installation: with screws or contact glue.
- Fire-resistance: B-s1,d0 (similar to M1).
- Environmentally friendly material.
- High-density board surface, paintable.
- Suitable for usage in large construction areas.
- Total thickness: 4,0 cm (1 4/7").
- The fact that it uses layers of Type X FR Gypsumboard and cement fibre board, enables its usage in construction as a fire barrier.

SIZES AND SPECIFICATIONS

MODELS	HEIGHT	WIDTH	DEPTH	WEIGHT
STLL III	244 cm (8' 0 0/1")	120 cm (3' 11 1/4")	4.0cm (1 4/7")	81.12 Kg (178.83 lbs)

WALL APPLICATION

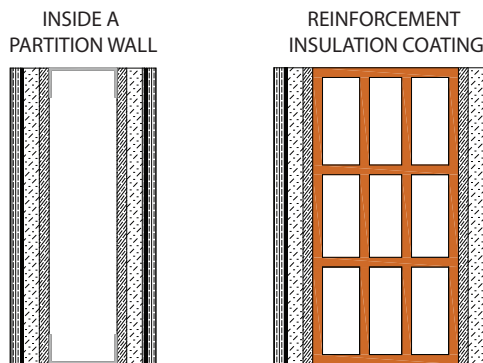

CEILING APPLICATION

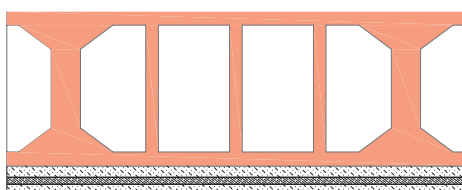

DESCRIPTION

STILLNESS is a damping system and sound insulation board composed of anti-vibration and massive elements. We've selected inorganic materials with different densities and thicknesses to form a composite layer with the best properties of sound insulation and vibration damping in order to effectively insulate the medium-low and low frequencies of the sound transmission. STILLNESS III is composed of a quad layer system made with our 10 mm FLOATSHEET INS, followed by high quality type X FR gypsum board, our 2 mm FLOATSHEET VIB and finished off with cement fiber board, when combined they can enhance the sound insulation between 18 and 22 dB, depending on the construction of the base of the wall or ceiling. This model has the third highest db reduction and is only 4 cm thick. The layers of each compound model are pressed and adhered under high pressure. These composite vibration damping and sound insulation boards are much more practical than the traditional layer-by-layer construction and provides an effective sound reduction rate of walls and ceilings in all types of applications, from the music business to the industrial market.

COMPOSITION

- STILLNESS® III is composed by:
- 1 layer of (10mm | 2/5") Polyurethane - Floatsheet® INS,
 - 1 layer of (16mm | 5/8") Type X FR Gypsumboard,
 - 1 layer of (2mm | 0/1") Floatsheet® VIB and
 - 1 layer of (12mm | 1/2") cement fibre board.

DIMENSIONS

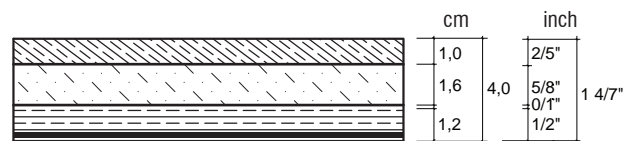

COMPOSITION



NOTICE

- JOCAVI® accepts no responsibility for any printing errors. Specifications can be modified without prior notice, if technical or commercial reasons so require.
- The colours shown on this catalogue are only a reference and an illustration of the products finishing. The colours shown are not binding because brightness, contrast and colour balance may vary due to the printing process.
- Colours may vary due to raw-material suppliers' changes and some differences may occur in tonal range. Sizes may vary slightly due to their production method and some inherent raw-materials characteristics.



STILLNESS IV[®]

SOUNDPROOFING PLATES

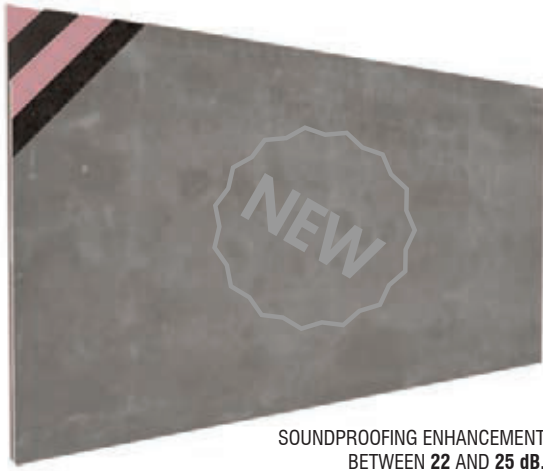

SOUNDPROOFING ENHANCEMENT BETWEEN 22 AND 25 dB.



Image of STILLNESS IV, Ref.:STLLIV, Soundproofing Plates of five layers.

FEATURES

- Depending on the constitution of the base of the wall or ceiling, this material can enhance the sound insulation between **22** and **25** db.
- Reduces sound transmission loss property.
- Installation: with screws or contact glue.
- Fire-resistance: B-s1,d0 (similar to M1).
- Environmentally friendly material.
- High-density board surface, paintable.
- Suitable for usage in large areas of construction.
- Total thickness: 5,6 cm (2 1/5").
- The fact that it uses layers of Type X FR Gypsumboard and cement fibre board, enables its usage in construction as a fire barrier.

SIZES AND SPECIFICATIONS

MODELS	HEIGHT	WIDTH	DEPTH	WEIGHT
STLL IV	244 cm (8' 0 0/1")	120 cm (3' 11 1/4")	5.6cm (2 1/5")	109,02 Kg (240.35 lbs)

WALL APPLICATION

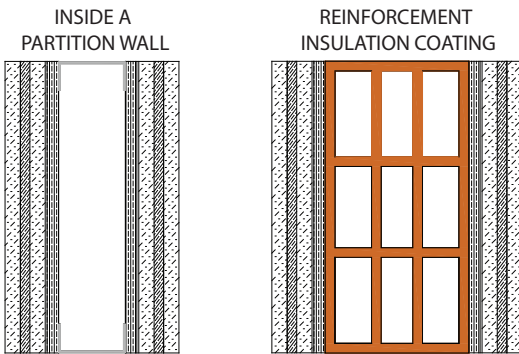

CEILING APPLICATION

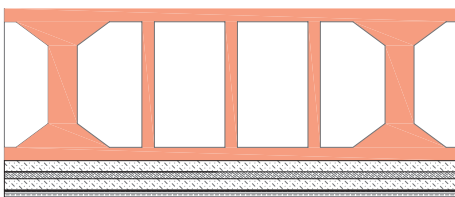

DESCRIPTION

STILLNESS is a damping system and sound insulation board composed of anti-vibration and massive elements. We've selected inorganic materials with different densities and thicknesses to form a composite layer with the best properties of sound insulation and vibration damping in order to effectively insulate the medium-low and low frequencies of the sound transmission. STILLNESS IV is composed of a 5 layer system built off the STLL III. Adding a top layer of high quality type X FR gypsum board, followed by our 10 mm FLOATSHEET INS, high quality type X FR gypsum board, our 2 mm FLOATSHEET VIB and finished off with cement fiber board, this combination can enhance the sound insulation between 22 and 25 dB, depending on the construction of the base of the wall or ceiling. This model has the second highest db reduction and is only 5.6 cm thick. The layers of each compound model are pressed and adhered under high pressure. These composite vibration damping and sound insulation boards are much more practical than the traditional layer-by-layer construction and provides an effective sound reduction rate of walls and ceilings in all types of applications, from the music business to the industrial market.

COMPOSITION

- STILLNESS® IV is composed by:
- 1 layer of (16mm | 5/8") Type X FR Gypsumboard,
 - 1 layer of (10mm | 2/5") Polyurethane - Floatsheet® INS,
 - 1 layer of (16mm | 5/8") Type X FR Gypsumboard,
 - 1 layer of (2mm | 0/1") Floatsheet® VIB and
 - 1 layer of (12mm | 1/2") cement fibre board.

DIMENSIONS

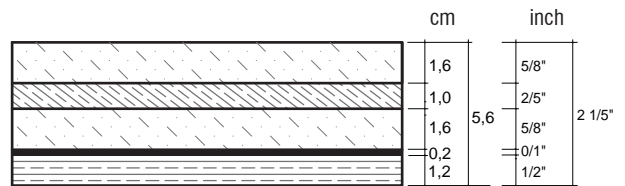

COMPOSITION

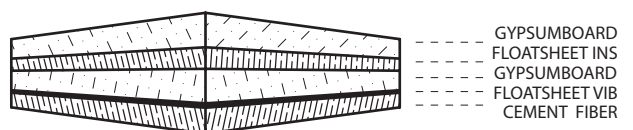

NOTICE

- JOCAVI® accepts no responsibility for any printing errors. Specifications can be modified without prior notice, if technical or commercial reasons so require.
- The colours shown on this catalogue are only a reference and an illustration of the products finishing. The colours shown are not binding because brightness, contrast and colour balance may vary due to the printing process.
- Colours may vary due to raw-material suppliers' changes and some differences may occur in tonal range. Sizes may vary slightly due to their production method and some inherent raw-materials characteristics.



STILLNESS V[®]

SOUNDPROOFING PLATES

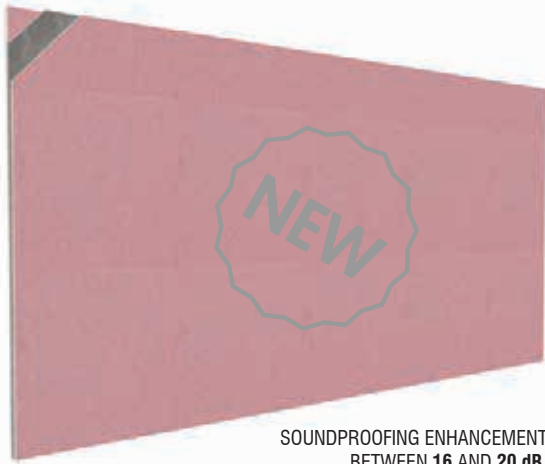

SOUNDPROOFING ENHANCEMENT
BETWEEN 16 AND 20 dB.



Image of STILLNESS V, Ref.:STLLV, Soundproofing Plates of three layers.

FEATURES

- Depending on the constitution of the base of the wall or ceiling, this material can enhance the sound insulation between **16** and **20** db.
- Reduces sound transmission loss property.
- Installation: with screws or contact glue.
- Fire-resistance: B-s1,d0 (similar to M1).
- Environmentally friendly material.
- High-density board surface, paintable.
- Suitable for usage in large areas of construction.
- Total thickness: 4,4 cm (1 3/4").
- The fact that it uses layers of Type X FR Gypsumboard and cement fibre board, enables its usage in construction as a fire barrier.

SIZES AND SPECIFICATIONS

MODELS	HEIGHT	WIDTH	DEPTH	WEIGHT
STLLV	244 cm (8' 0 0/1")	120 cm (3' 11 1/4")	4.4cm (1 3/4")	92.80 Kg (240.35 lbs)

WALL APPLICATION

INSIDE A
PARTITION WALL

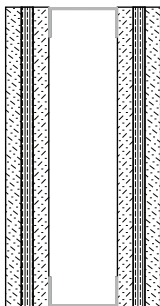

REINFORCEMENT
INSULATION COATING

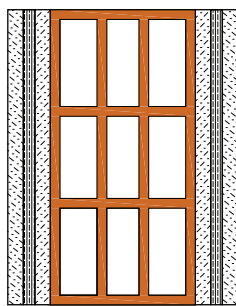

CEILING APPLICATION

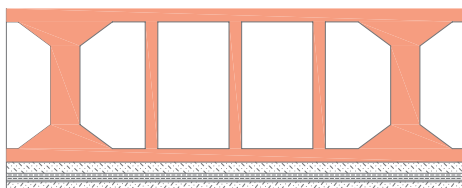

DESCRIPTION

STILLNESS is a damping system and sound insulation board composed of anti-vibration and massive elements. We've selected inorganic and organic materials with different densities and thicknesses to form a composite layer with the best properties of sound insulation and vibration damping in order to effectively insulate the medium-low and low frequencies of the sound transmission. STILLNESS V is composed of a triple layer system made with high quality type X FR gypsum board, cement fiber board, high quality type X FR gypsum board and finished off with your choice of anti-vibratic material. This particular model was designed to be custom tailored to meet a wide range of db reduction, alone the tree layers can enhance the sound insulation from 16 to 20 db and when combining our *ARG or **ECOiso board they can enhance the sound insulation up to 74 dB, depending on the base of the wall or ceiling. The layers of each compound model are pressed and adhered under high pressure. These composite vibration damping and sound insulation boards are much more practical than the traditional layer-by-layer construction and provides an effective sound reduction rate of walls and ceilings in all types of applications, from the music business to the industrial market.

COMPOSITION

STILLNESS® V is composed by:

- 1 layer of (16mm | 5/8") Type X FR Gypsumboard,
- 1 layer of (12mm | 1/2") cement fibre board.
- 1 layer of (16mm | 5/8") Type X FR Gypsumboard,

DIMENSIONS

	cm	inch	
	1,6	5/8"	1 3/4"
	1,2	1/2"	
	1,6	5/8"	

COMPOSITION

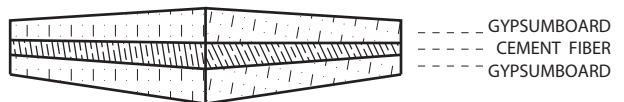

NOTICE

- JOCAVI® accepts no responsibility for any printing errors. Specifications can be modified without prior notice, if technical or commercial reasons so require.
- The colours shown on this catalogue are only a reference and an illustration of the products finishing. The colours shown are not binding because brightness, contrast and colour balance may vary due to the printing process.
- Colours may vary due to raw-material suppliers' changes and some differences may occur in tonal range. Sizes may vary slightly due to their production method and some inherent raw-materials characteristics.



STILLNESS VI[®]

SOUNDPROOFING PLATES



SOUNDPROOFING ENHANCEMENT BETWEEN 25 AND 28 dB.



Image of STILLNESS VI, Ref.:STLLVI, Soundproofing Plates of three layers.

FEATURES

- Depending on the constitution of the base of the wall or ceiling, this material can enhance the sound insulation between **25** and **28** db.
- Reduces sound transmission loss property.
- Installation: with screws or contact glue.
- Fire-resistance: B-s1,d0 (similar to M1).
- Environmentally friendly material.
- High-density board surface, paintable.
- Suitable for usage in large areas of construction.
- Total thickness: 10,4 cm (4 0/1").
- The fact that it uses layers of Type X FR Gypsumboard and cement fibre board, enables its usage in construction as a fire barrier.

SIZES AND SPECIFICATIONS

MODELS	HEIGHT	WIDTH	DEPTH	WEIGHT
STLLVI	244 cm (8' 0 0/1")	120 cm (3' 11 1/4")	10.4cm (4 0/1")	111.38 Kg (245.55 lbs)

WALL APPLICATION

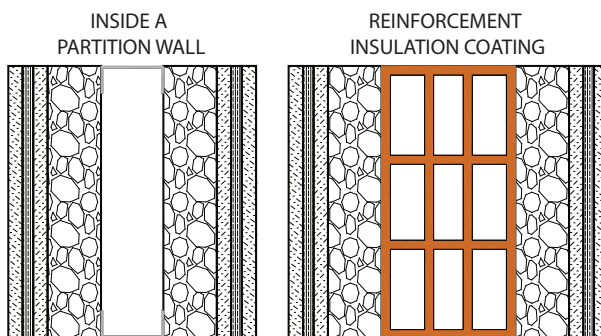

CEILING APPLICATION

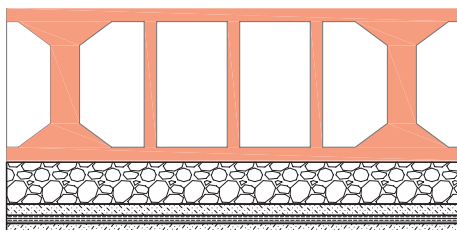

DESCRIPTION

STILLNESS is a damping system and sound insulation board composed of anti-vibration and massive elements. We select inorganic materials with different densities and thicknesses to form a composite layer with the best properties of sound insulation and vibration damping in order to effectively insulate the medium-low and low frequencies of the sound transmission. STILLNESS VI is composed of a quad layer system built off the concept of our STLL V. Starting off with a top layer of high quality type X FR gypsum board, followed by cement fiber board, high quality type X FR gypsum board finished off with our 60 mm ARG, this combination can enhance the sound insulation between 25 and 28 dB, depending on the construction of the base of the wall or ceiling. This is our highest db reduction in a fixed model, making this out "best" option. The layers of each compound model are pressed and adhered under high pressure. These composite vibration damping and sound insulation boards are much more practical than the traditional layer-by-layer construction and provides an effective sound reduction rate of walls and ceilings in all types of applications, from the music business to the industrial market.

COMPOSITION

- STILLNESS® VI is composed by:
- 1 layer of (16mm | 5/8") Type X FR Gypsumboard,
 - 1 layer of (12mm | 1/2") cement fibre board.
 - 1 layer of (16mm | 5/8") Type X FR Gypsumboard,
 - 1 layer of (60mm | 2 1/3") IN® ARG060,

DIMENSIONS

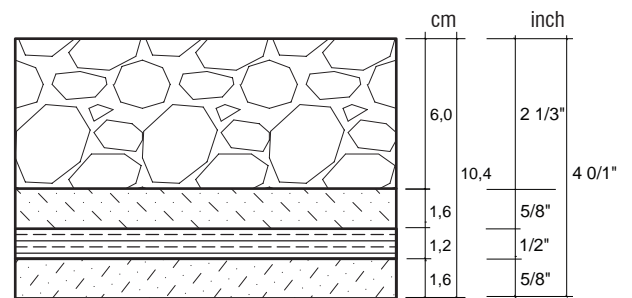

COMPOSITION

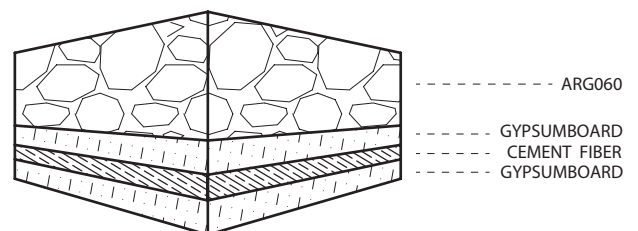

NOTICE

- JOCAVI® accepts no responsibility for any printing errors. Specifications can be modified without prior notice, if technical or commercial reasons so require.
- The colours shown on this catalogue are only a reference and an illustration of the products finishing. The colours shown are not binding because brightness, contrast and colour balance may vary due to the printing process.
- Colours may vary due to raw-material suppliers' changes and some differences may occur in tonal range. Sizes may vary slightly due to their production method and some inherent raw-materials characteristics.



AIRBILLOW®

ABSORBENT PANEL

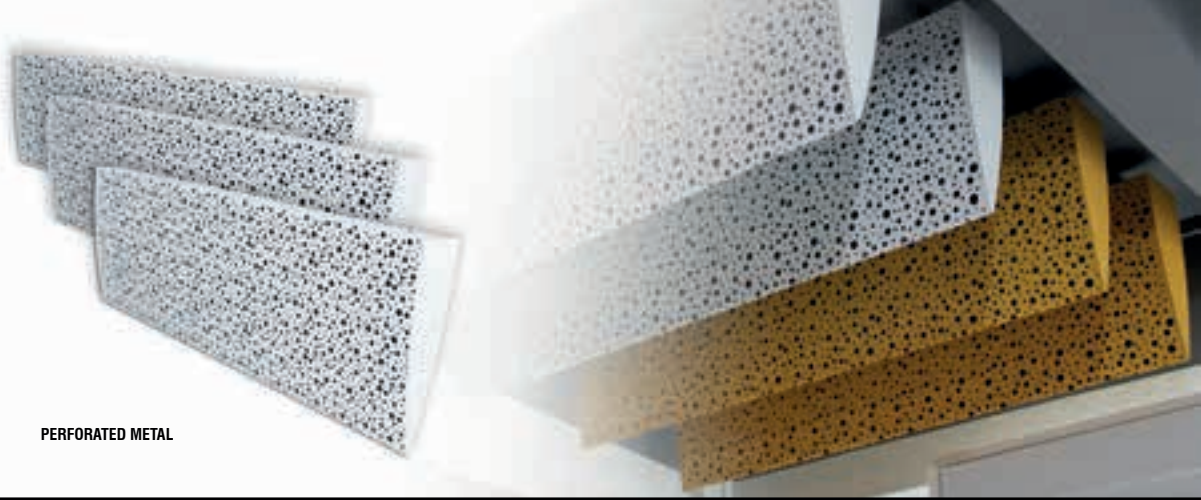

PERFORATED METAL

Image of model Ref.:MTBL150V (on the left) and applied (ambient image).

DESCRIPTION

AIRBILLOW® is an absorbent suspending panel mainly meant for big venues like: stadiums, large halls, airports, subways and bus stations, as well as for industrial applications. It can also be applied in moist environments and outdoors.

AIRBILLOW® it is different in aesthetic terms, its triangular shape is attractive and provides pleasant combinations. It is available in several colors and it is easy to install suspending on the ceilings.

This panel's structure is made on a holed metal lacquered plate, which gives the product a good robustness; the interior is built by combining absorbent raw materials made from mineral fibers in different layers and densities. These products are applicable on a ceiling, suspended with the provided accessories.

The typical public and industrial spaces require an adequate noise control in order to provide good sound perception. This model has a good absorption coefficient in mid-low spectrum, concentrated within 400Hz to 1250Hz, which is very important to improve the absorption in the sound frequencies of the common noise.

FEATURES

- Made of metal lacquered plate and different raw absorbent materials inside.
- NRC: **1.05/m²**.
- Fire-resistance: B-s1,d1 (similar to old M1).
- Several and pleasant combinations.
- Good robustness and air noise control.
- Suitable for areas with large space, e.g. stadiums, airports and bus stations, pavilions as well as for public or industrial facilities.

TECHNICAL DRAWINGS

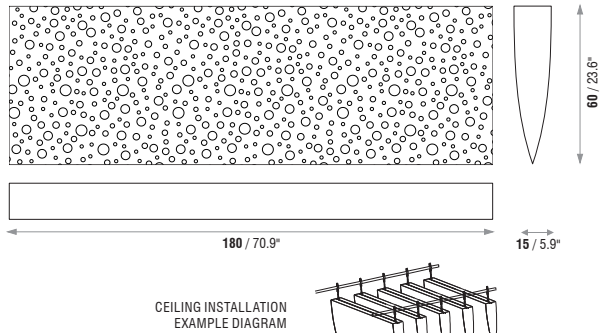

MODELS AND SIZES

MODELS	HEIGHT	WIDTH	DEPTH	WEIGHT
MTBL150V	180 cm (70.9 in)	60 cm (23.6 in)	15 cm (5.9 in)	9.4 Kg (20.72 lbs)

ABSORPTION COEFFICIENT

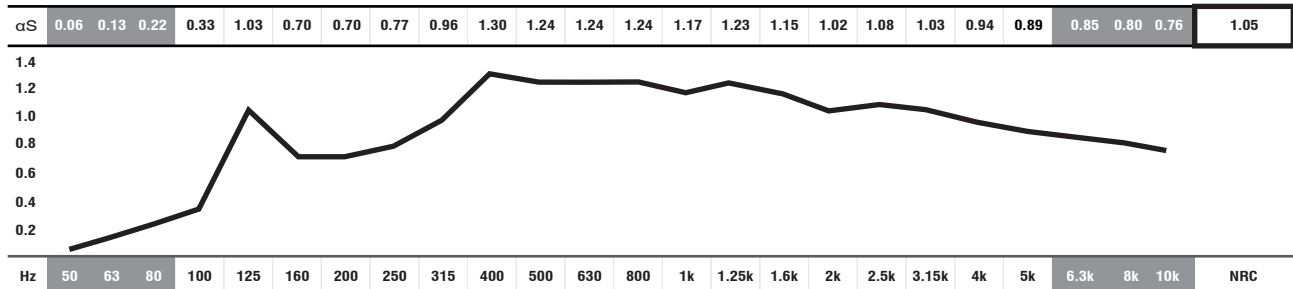

■ ABSORPTION COEFFICIENT: Values in accordance with the standards: EN 20654, ASTM C423 and EN 11654.

■ Values [$<100\text{Hz}$ and $>5\text{K}$] are Non Standard Values.

STANDARD COLOURS



IMPORTANT NOTICES

- JOCAVI® accepts no responsibility for any printing errors. Specifications can be modified without prior notice, if technical or commercial reasons so require.
- The colours shown on this catalogue are only a reference and an illustration of the products finishing. The colours shown are not binding because brightness, contrast and colour balance may vary due to the printing process.
- Colours may vary due to raw-material suppliers' changes and some differences may occur in tonal range. Close attention must be paid to the storage conditions and the acclimatization before, during and after the installation.
- Typical Indoor Comfort Standards state a temperature range of 20°C - 27°C (68°F - 81°F), and a relative humidity of less than 60%. These would be considered as normal operational levels of JOCAVI® products' range.
- Despite all the standard sizes of all products, this model can be customised upon previous consultation. Sizes may vary slightly due to their production method and some inherent raw-materials characteristics.



AIRFLAT® ABSORBENT PANEL



Image of 120x60cm model Ref.:MTAF050

DESCRIPTION

The AIRFLAT® is an additional option as an absorption panel. This panel's structure is made on an aluminum frame, which gives the product a good robustness; the absorbent layer is built in a mineral fiber plate with viselike fabric that makes the finishing.

It is mainly meant for stadiums, large halls, airports, subways and bus stations, as well as for industrial applications. It can also be applied in moist environments or outdoors.

The AIRFLAT® is available in several colors with the same acoustic features. It is easy to install hanging on ceilings.

The typical public and industrial spaces require an adequate planning of acoustics in order to provide good noise control and sound reception. This product provides a good absorption coefficient at mid frequency range, exactly within the area where the largest common noise occur.

TECHNICAL DRAWINGS

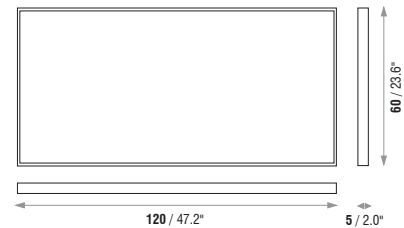

HORIZONTAL INSTALLATION DIAGRAM

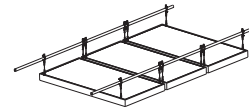

FEATURES

- Made on an aluminium frame and different raw absorbent materials inside.
- NRC: **0.66/m²**.
- Fire-resistance: B-s1,d1 (similar to old M1).
- Several combinations and positioning.
- Good robustness and airborne noise control.
- Can be used in different environments.
- Suitable for areas with large space, subways, stadiums, airports and bus stations, pavilions as well as for public or industrial facilities.

MODELS AND SIZES

MODELS	HEIGHT	WIDTH	DEPTH	WEIGHT
MTAF050	120 cm (47.2 in)	60 cm (23.6 in)	5 cm (2.0 in)	4 Kg (8.82 lbs)

ABSORPTION COEFFICIENT

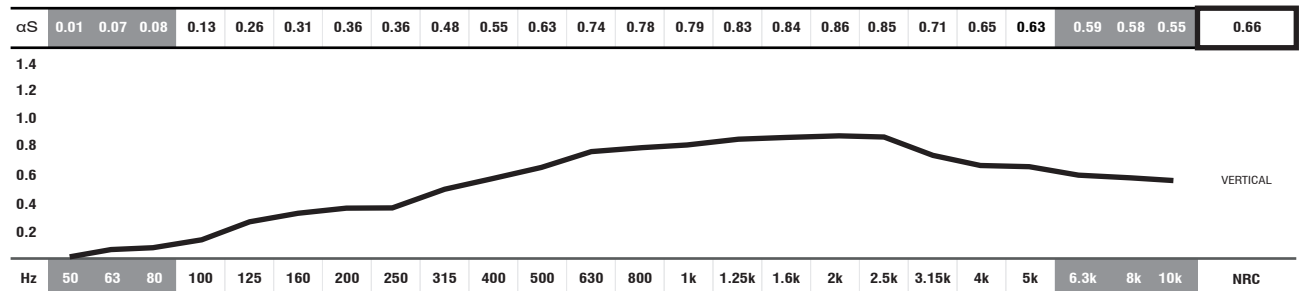

■ ABSORPTION COEFFICIENT: Values in accordance with the standards: EN 20654, ASTM C423 and EN 11654.

■ Values [<100Hz and > 5K] are Non Standard Values.

STANDARD COLOURS



BLACK



GREY



WHITE

IMPORTANT NOTICES

- JOCAVI® accepts no responsibility for any printing errors. Specifications can be modified without prior notice, if technical or commercial reasons so require.
- The colours shown on this catalogue are only a reference and an illustration of the products finishing. The colours shown are not binding because brightness, contrast and colour balance may vary due to the printing process.
- Colours may vary due to raw-material suppliers' changes and some differences may occur in tonal range. Close attention must be paid to the storage conditions and the acclimatization before, during and after the installation.
- Typical Indoor Comfort Standards state a temperature range of 20°C - 27°C (68°F - 81°F), and a relative humidity of less than 60%. These would be considered as normal operational levels of JOCAVI® products' range.
- Despite all the standard sizes of all products, this model can be customised upon previous consultation. Sizes may vary slightly due to their production method and some inherent raw-materials characteristics.



AIRHOLED® ABSORBENT PANEL



Image of 120x60cm model Ref.:MTHL100D.

DESCRIPTION

AIRHOLED® is an absorbent suspension panel mainly meant for stadiums, large halls, airports, subways and bus stations, as well as for industrial applications. It can also be applied in moist environments and outdoors.

This panel's structure is made on a holed metal lacquered plate, which gives the product a good robustness; the interior is built by combining absorbent raw materials made from mineral fibers in different layers and densities. These products are applicable to ceiling, suspended with the provided accessories.

The typical public and industrial spaces require an adequate planning of acoustics in order to provide good noise control and sound perception. AIRHOLED® has a good absorption coefficient in mid range spectrum, which is very important to improve the absorption of the airborne noise in big venues.

FEATURES

- Made of metal lacquered plate and different raw absorbent materials inside.
- NRC: **0.68/m²**.
- Fire-resistance: B-s1,d1 (similar to old M1).
- Several combinations and positionings: vertical, horizontal and 45°.
- Good robustness and airborne noise control.
- Suitable for areas with large space, subways, stadiums, airports and bus stations, pavilions as well as for public or industrial facilities.

TECHNICAL DRAWINGS

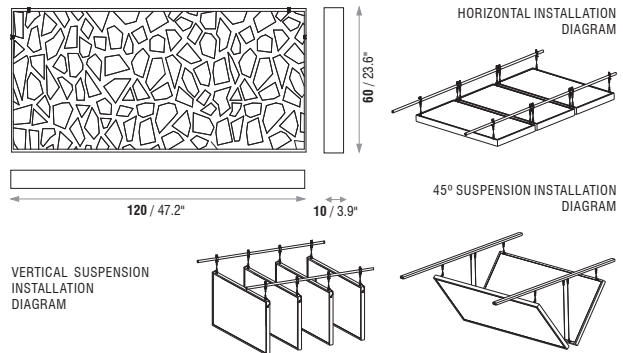

MODELS AND SIZES

MODELS	HEIGHT	WIDTH	DEPTH	WEIGHT
MTHL100D	120 cm (47.2 in)	60 cm (23.6 in)	10 cm (3.9 in)	8.7 Kg (19.18 lbs)

ABSORPTION COEFFICIENT

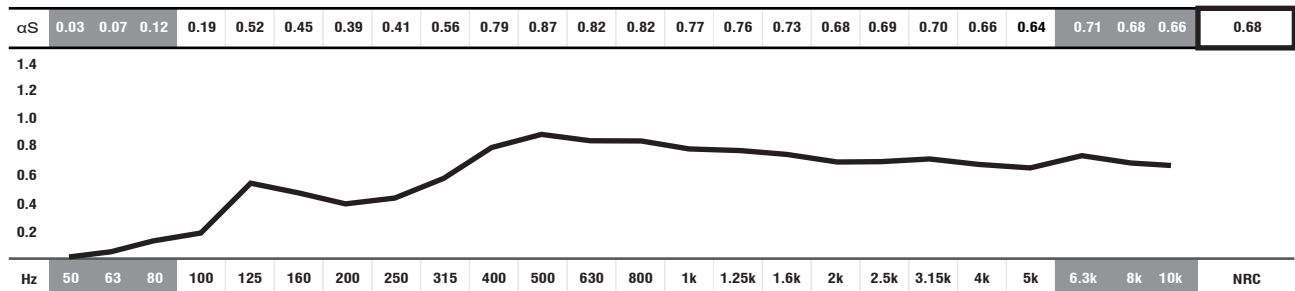

■ ABSORPTION COEFFICIENT: Values in accordance with the standards: EN 20654, ASTM C423 and EN 11654.

■ Values [$<100\text{Hz}$ and $>5\text{K}$] are Non Standard Values.

STANDARD COLOURS



IMPORTANT NOTICES

- JOCAVI® accepts no responsibility for any printing errors. Specifications can be modified without prior notice, if technical or commercial reasons so require.
- The colours shown on this catalogue are only a reference and an illustration of the products finishing. The colours shown are not binding because brightness, contrast and colour balance may vary due to the printing process.
- Colours may vary due to raw-material suppliers' changes and some differences may occur in tonal range. Close attention must be paid to the storage conditions and the acclimatization before, during and after the installation.
- Typical Indoor Comfort Standards state a temperature range of 20°C - 27°C (68°F - 81°F), and a relative humidity of less than 60%. These would be considered as normal operational levels of JOCAVI® products' range.
- Despite all the standard sizes of all products, this model can be customised upon previous consultation. Sizes may vary slightly due to their production method and some inherent raw-materials characteristics.



AIRPERF®
ABSORBENT PANEL



PERFORATED METAL



Image of 120x60cm model Ref.:MTPF100Q.

DESCRIPTION

JOCAVI® has developed this range of acoustic absorbent panels, mainly meant for stadiums, large halls, airports, subways and bus stations, as well as for industrial applications. It can also be applied in moist environments and outdoors.

This panel's structure is made on a perforated metal lacquered plate, which gives the product a good robustness; the interior is built by combining absorbent raw materials made from mineral fibers in different layers and densities. These products are applicable to ceilings and suspended with the provided accessories.

The typical public and industrial spaces require an adequate planning of acoustics in order to provide good sound reception. Due to its composite absorption layer, the AIRPERF® has a good absorption coefficient in mid and mid-low spectrum, which is very important to reduce the airborne noise in the frequencies common noise range.

FEATURES

- Made of metal lacquered plate and different raw absorbent materials inside.
- NRC: **0.76/m²**.
- Fire-resistance: B-s1,d1 (similar to old M1).
- Several combinations and positionings: vertical, horizontal and 45°.
- Good robustness and airborne noise control.
- Suitable for areas with large space, subways, stadiums, airports and bus stations, pavilions as well as for public or industrial facilities.

TECHNICAL DRAWINGS

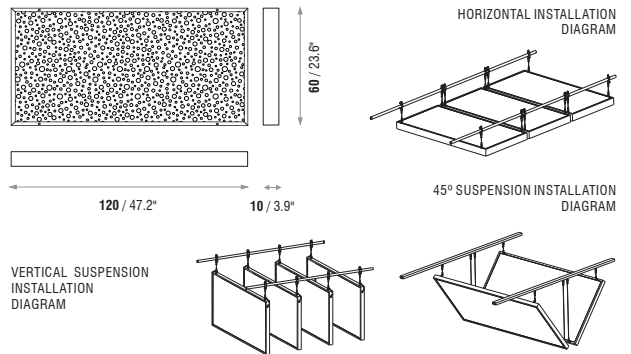

MODELS AND SIZES

MODELS	HEIGHT	WIDTH	DEPTH	WEIGHT
MTPF100Q	120 cm (47.2 in)	60 cm (23.6 in)	10 cm (3.9 in)	7.1 Kg (15.65 lbs)

ABSORPTION COEFFICIENT

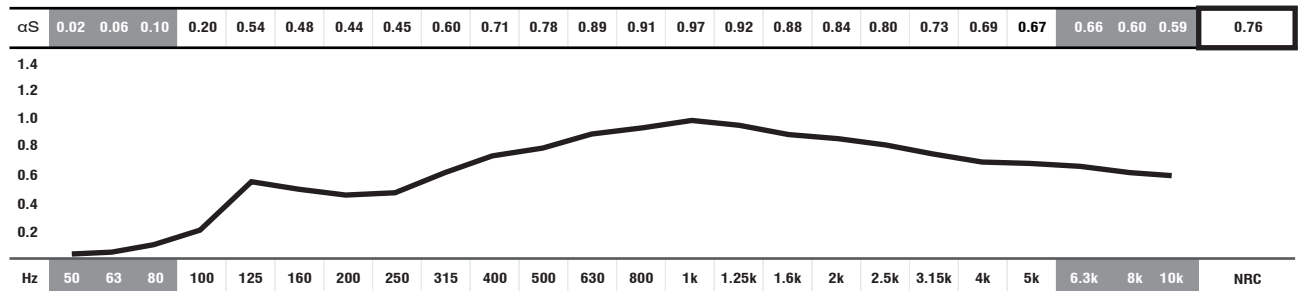

■ ABSORPTION COEFFICIENT: Values in accordance with the standards: EN 20654, ASTM C423 and EN 11654.

■ Values [$<100\text{Hz}$ and $>5\text{K}$] are Non Standard Values.

STANDARD COLOURS



BEIGE



GREY



BLACK

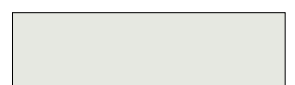

WHITE

IMPORTANT NOTICES

- JOCAVI® accepts no responsibility for any printing errors. Specifications can be modified without prior notice, if technical or commercial reasons so require.
- The colours shown on this catalogue are only a reference and an illustration of the products finishing. The colours shown are not binding because brightness, contrast and colour balance may vary due to the printing process.
- Colours may vary due to raw-material suppliers' changes and some differences may occur in tonal range. Close attention must be paid to the storage conditions and the acclimatization before, during and after the installation.
- Typical Indoor Comfort Standards state a temperature range of 20°C - 27°C (68°F - 81°F), and a relative humidity of less than 60%. These would be considered as normal operational levels of JOCAVI® products' range.
- Despite all the standard sizes of all products, this model can be customised upon previous consultation. Sizes may vary slightly due to their production method and some inherent raw-materials characteristics.



AIRTUBE® ABSORBENT PANEL



PERFORATED METAL

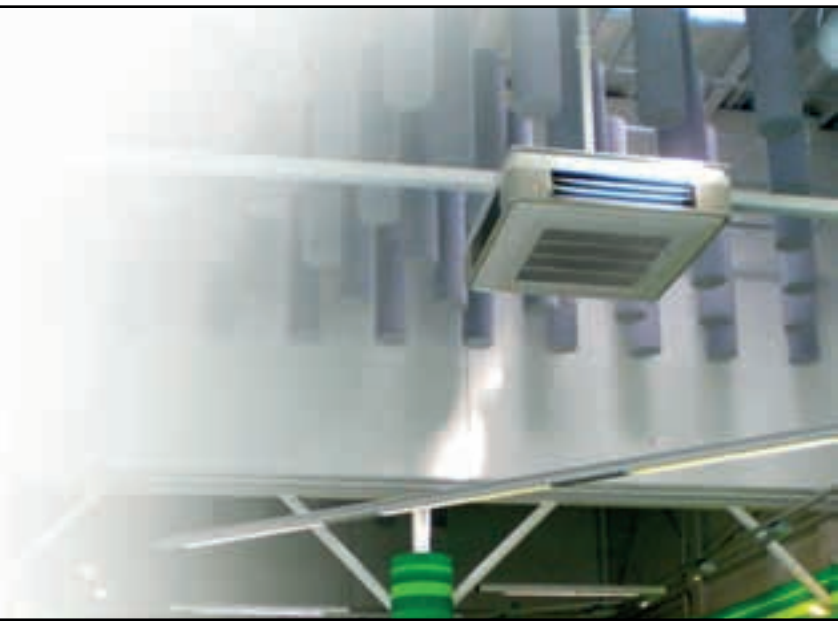

Image of 100x32cm model Ref.:MTAT032.

DESCRIPTION

AIRTUBE® is a tube-shaped absorbent panel that can be suspended in vertical or horizontal position providing pleasant combinations. This model is mainly meant for stadiums, large halls, airports, subways and bus stations, as well as for industrial applications. It can also be applied in moist environments and outdoors.

This panel's structure is made on a holed metal lacquered plate, which gives the product a good robustness; the interior is built with mineral fibres in different layers and densities. It is available in several colors and it is easy to install with the supplied accessories.

Big venues and industrial spaces require an adequate noise control in order to provide good sound perception. Due to its formation, the AIRTUBE® has a good absorption values at the mid-range of the sound spectrum, which is very important to improve the reduction of the common air-noise.

FEATURES

- Made of metal lacquered plate.
- NRC: **0.95/m²**.
- Fire-resistance: B-s1,d1 (similar to old M1).
- Several and pleasant combinations.
- Can be suspended horizontal or vertical positions.
- Suitable for areas with large space, e.g. stadiums, airports and bus stations, as well as for industrial facilities.

TECHNICAL DRAWINGS

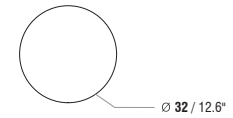
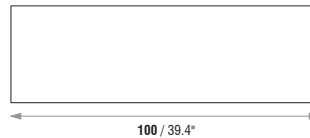

HORIZONTAL INSTALLATION
EXAMPLE DIAGRAM

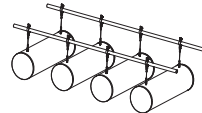

VERTICAL INSTALLATION
EXAMPLE DIAGRAM



MODELS AND SIZES

MODELS	HEIGHT	DIAMETER	WEIGHT
MTAT032	100 cm (39.4)	Ø 32 cm (12.6 in)	7.2 Kg (15.87 lbs)

ABSORPTION COEFFICIENT

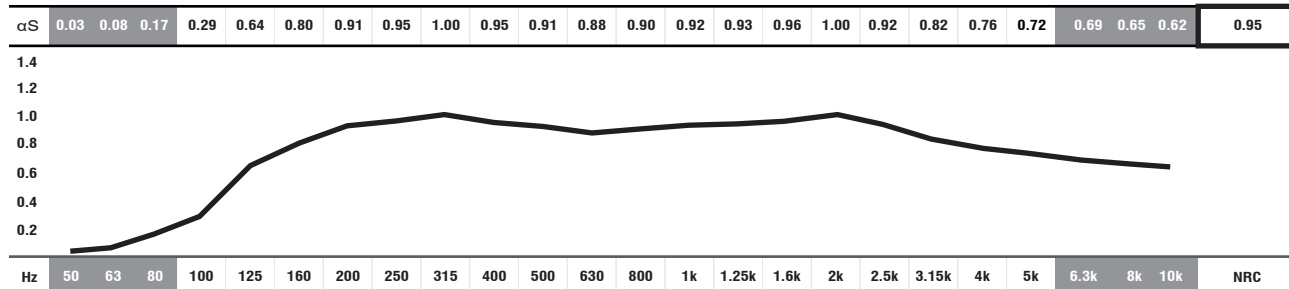

■ ABSORPTION COEFFICIENT: Values in accordance with the standards: EN 20654, ASTM C423 and EN 11654.

■ Values [$<100\text{Hz}$ and $>5\text{K}$] are Non Standard Values.

STANDARD COLOURS



BEIGE



GREY



BLACK

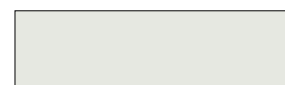

WHITE

IMPORTANT NOTICES

- JOCAVI® accepts no responsibility for any printing errors. Specifications can be modified without prior notice, if technical or commercial reasons so require.
- The colours shown on this catalogue are only a reference and an illustration of the products finishing. The colours shown are not binding because brightness, contrast and colour balance may vary due to the printing process.
- Colours may vary due to raw-material suppliers' changes and some differences may occur in tonal range. Close attention must be paid to the storage conditions and the acclimatization before, during and after the installation.
- Typical Indoor Comfort Standards state a temperature range of 20°C - 27°C (68°F - 81°F), and a relative humidity of less than 60%. These would be considered as normal operational levels of JOCAVI® products' range.
- Despite all the standard sizes of all products, this model can be customised upon previous consultation. Sizes may vary slightly due to their production method and some inherent raw-materials characteristics.



ENHANCE YOUR COMFORT, DECORATE ACOUSTICALLY

MAIN INFO

Motif® is a finishing for digital printing on fabric or wood. Challenge your imagination and choose the finishing you want for your space without any limitation.

We print any image on wood or fabric for our panels, just choose from our gallery or send us your image.

Available on all JOCAVI® models with a finishing in wood or fabric:

Addsorb®, LeakyFM®, Mellowalltrap®, Lightwalltrap® (except for some models), Convexabsorber®, Basscorner®, Roundbasscorner®, Walltrap®, Basslayer®, Tubabsorber® and Tubabsorber®SY, Mellowaffle®.

All these models may have the image you want as a finishing, as an alternative to the usual colours and textures.

FEATURES

- Printed on fabric or wood.
- Acoustically transparent textile and/or perforated wood.
- Same acoustic performance as the original models.
- Exclusive customized images guaranteed by our One of a Kind department.
- Fire security requirements (B1) for public use (fabric finishing).
- High-quality print, using CMYK colour system and resolution up to 1080 dpi.
- Custom-made by size and images.
- Large-scale seamless images.

EXAMPLES OF MODELS SIZES AND COMBINATIONS

LIGHTWALLTRAP®

STANDARD SIZES OTHER SIZES AND COMBINATIONS AVAILABLE UNDER REQUEST

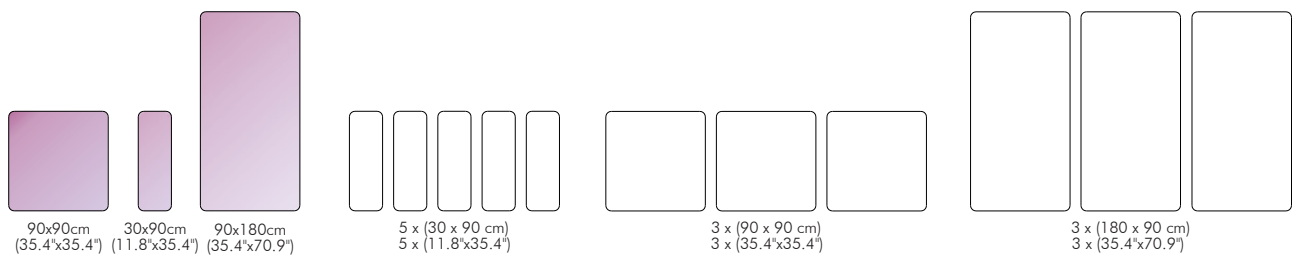

MELLOWALLTRAP® ADDSORB® LEAKY FM®

STANDARD SIZES OTHER SIZES AND COMBINATIONS AVAILABLE UNDER REQUEST

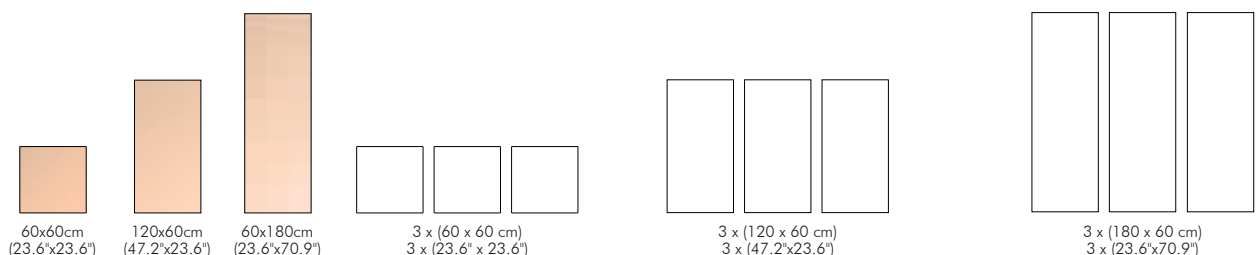

MOTIF®

PRINTED IMAGE FINISHING



ON WOOD

3x Addisorb®
120x60cm
 (47.2"x23.6")

Motif® is a new image printed finishing meant to widen the decorating options on acoustic panels. It can be used on the Addisorb® and LeakyFM® wood-finishing models, while keeping the same acoustic performance as the original models.

Besides the 6 standard wood veneer finishings and the 10 standard coloured wood fibre JOCAVI® colours, Motif® image printed finishing line provides an option for those who want a more personalised solution. The Motif® image printed finishing line offers a sophisticated look with our acoustically perforated woods, which are available in a multitude of design options that perfectly match decor of your space.

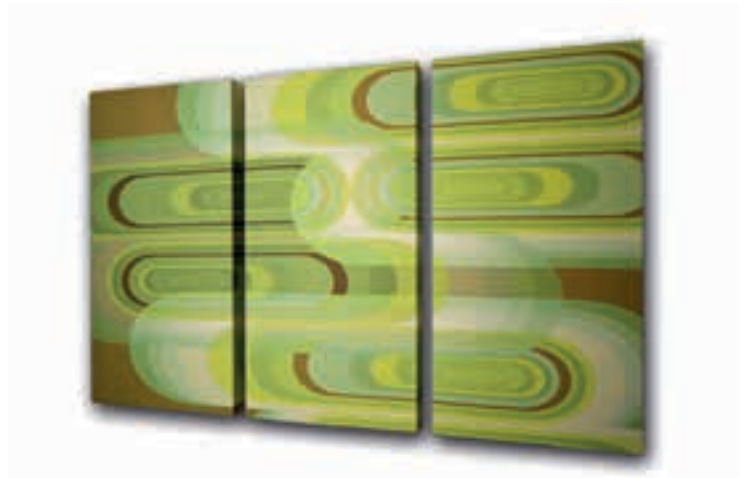

ON FABRIC

3x Mellowalltrap®
120x60cm
 (47.2"x23.6")

Motif® is a new printed textile finishing meant to widen the decorating options on acoustic panels. It can be used on the Mellowalltrap® and Lightwalltrap® fabric-finishing models (e.g.), while keeping the same acoustic performance as the original models.

Besides the 15 standard JOCAVI® colours, Motif® provides an option for those who want a more personalised solution (except with some models). The Motif® printed textile finishing line offers a sophisticated look with our acoustically transparent fabric, which is available in a multitude of design options that perfectly match decor of your space.

ONE OF A KIND

Motif® offers a new possibility to use acoustic elements in a unique customised interior design. Sound control solutions need to meet greater acoustic demands while maintaining an aesthetic appeal.

Acoustic Panels help control the excessive reverberation and echoes caused by the hard surfaces of construction materials. The strategic placement of acoustic panels on walls and ceilings helps absorb unwanted sound energy and causes a reduction of acoustic defects. Thus, you can hear your music and movies as they were meant to be heard.

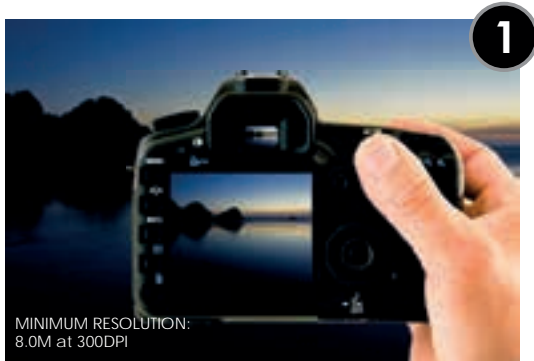

MINIMUM RESOLUTION:
 8.0M at 300DPI



SEND US YOUR IMAGE
 (photography or vector)

MOTIF® images can be obtained by printing them from our image data bank or by using our design services for individual designs or customers' own images, texts and symbols.

A precise evaluation of the customers' files resolution will be confirmed before printing. The **One of a Kind** department guarantees the quality and exclusivity of your file printing, which will be used only once and only for you.

Different colours and patterns can be used for printing. The quality of our textiles used with the pictures fulfils the fire security requirements (B1) for public use.



SOME IMAGES FROM OUR GALLERY (check online at jocavi.net)



REF: URB-01

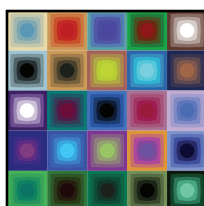

REF: ART-01

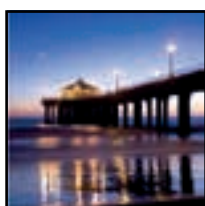

REF: LAN-01



REF: MUS-01



REF: LAN-04

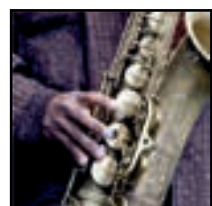

REF: MUS-02

STANDARD FABRIC • COLOURS

JOCAVI® AND ATP® FABRIC COLOURS

BRANDS



MODELS

Basscorner • Roundbasscorner • Tubabsorber • Tubabsorber SY • Basslayer • Walltrap • Ebony • Convexabsorber • Mellowalltrap • Lightwalltrap • Mellowaffle • Ripple • Mellowcloud ABS • Camou • Basmel • LF Camou • LF Tone • Tonal • Twin



BEIGE
APPROXIMATE TO RAL 1011



YELLOW
APPROXIMATE TO RAL 1003



ORANGE
APPROXIMATE TO RAL 2001



RED
APPROXIMATE TO RAL 3003

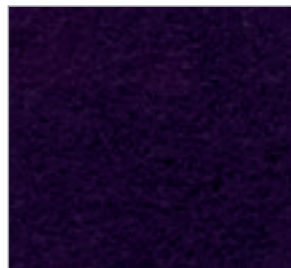

PURPLE
APPROXIMATE TO RAL 4007



LIGHT BLUE
APPROXIMATE TO RAL 5010



BLUE
APPROXIMATE TO RAL 5013



GREEN
APPROXIMATE TO RAL 6028



BROWN
APPROXIMATE TO RAL 8019



LIGHT GREY
APPROXIMATE TO RAL 7001



GREY
APPROXIMATE TO RAL 7015



BLACK
APPROXIMATE TO RAL 9005

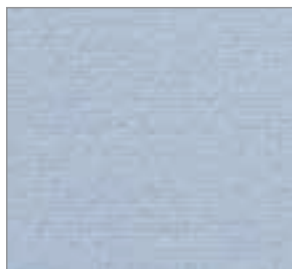

WHITE
APPROXIMATE TO RAL 9003

NOTICE

- COLOURS MAY VARY DUE TO SUPPLIERS' CHANGES AND SOME DIFFERENCES MAY OCCUR IN TONAL RANGE.
- JOCAVI® ACCEPTS NO RESPONSABILITY FOR ANY PRINTING ERRORS.
- OTHER COLOURS UNDER CONSULTING AND WITH A MINIMUM QUANTITY ORDER.
- SPECIFICATIONS CAN BE MODIFIED WITHOUT PRIOR NOTICE, IF TECHNICAL OR COMMERCIAL REASONS SO REQUIRE.

PREMIUM FABRIC • COLOURS

JOCAVI® AND ATP® FABRIC COLOURS

BRANDS



MODELS

Basscorner • Roundbasscorner • Tubabsorber • Tubabsorber SY • Basslayer • Walltrap • Ebony • Convexabsorber • Mellowalltrap • Lightwalltrap • Mellowaffle • Ripple • Mellowcloud ABS • Camou • Basmel • LF Camou • LF Tone • Tonal • Twin

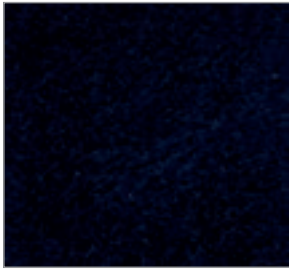

BLUE - MC24
APPROXIMATE TO RAL 1011



BROWN - MC11
APPROXIMATE TO RAL 1003



RED - MC47
APPROXIMATE TO RAL 2001



BLUE - MC22
APPROXIMATE TO RAL 3003



BROWN - MC9
APPROXIMATE TO RAL 4007



ORANGE - MC33
APPROXIMATE TO RAL 5010



BLUE - MC21
APPROXIMATE TO RAL 5013



BROWN - MC36
APPROXIMATE TO RAL 6028



ORANGE - MC29
APPROXIMATE TO RAL 8019



BLACK - MC19
APPROXIMATE TO RAL 7001



BEIGE - MC4
APPROXIMATE TO RAL 7015



GREEN - MC16
APPROXIMATE TO RAL 9005



GREY - MC15
APPROXIMATE TO RAL 9003



GOLD - MC28
APPROXIMATE TO RAL 9003

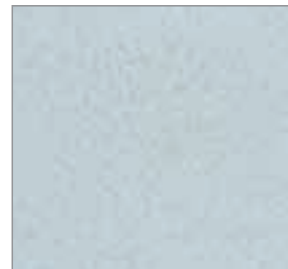

WHITE - MC15
APPROXIMATE TO RAL 9003

NOTICE

- COLOURS MAY VARY DUE TO SUPPLIERS' CHANGES AND SOME DIFFERENCES MAY OCCUR IN TONAL RANGE.
- JOCAVI® ACCEPTS NO RESPONSABILITY FOR ANY PRINTING ERRORS.
- OTHER COLOURS UNDER CONSULTING AND WITH A MINIMUM QUANTITY ORDER.
- SPECIFICATIONS CAN BE MODIFIED WITHOUT PRIOR NOTICE, IF TECHNICAL OR COMMERCIAL REASONS SO REQUIRE.

STANDARD PAINTED • COLOURS

HIGH DENSITY EPS AND PROJECTABLE CELLULOSE INK COLOURS

BRANDS



MODELS

Coralreef • Ivory • Wallblind (diffusion surface) • Mellowcloud DIF • Wavyfuser • Stripefuser • Reflex • Bassweakner • Basskeeper Angle • Basskeeper Wall • Camou (box) • Cosmos (box) • LF Tone (box)



BEIGE
APPROXIMATE TO RAL 1011



YELLOW
APPROXIMATE TO RAL 1003



ORANGE
APPROXIMATE TO RAL 2001



RED
APPROXIMATE TO RAL 3003

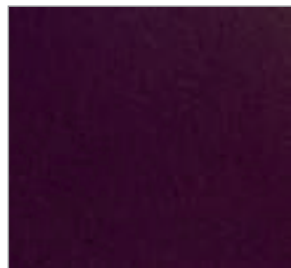

PURPLE
APPROXIMATE TO RAL 4007



LIGHT BLUE
APPROXIMATE TO RAL 5010



BLUE
APPROXIMATE TO RAL 5013



GREEN
APPROXIMATE TO RAL 6028



BROWN
APPROXIMATE TO RAL 8019



LIGHT GREY
APPROXIMATE TO RAL 7001



GREY
APPROXIMATE TO RAL 7015



BLACK
APPROXIMATE TO RAL 9005

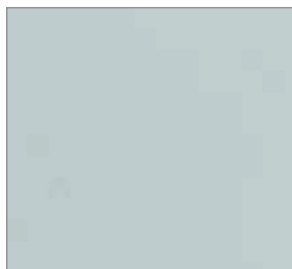

WHITE
APPROXIMATE TO RAL 9003

NOTICE

- COLOURS MAY VARY DUE TO SUPPLIERS' CHANGES AND SOME DIFFERENCES MAY OCCUR IN TONAL RANGE.
- JOCAVI® ACCEPTS NO RESPONSABILITY FOR ANY PRINTING ERRORS.
- OTHER COLOURS UNDER CONSULTING AND WITH A MINIMUM QUANTITY ORDER.
- SPECIFICATIONS CAN BE MODIFIED WITHOUT PRIOR NOTICE, IF TECHNICAL OR COMMERCIAL REASONS SO REQUIRE.

FOAM • TYPES AND COLOURS

ACOUSTIC, MELAMINE AND PE FOAM FINISHINGS

BRANDS



MODELS

(A) Wallblind (absorbent surface) • Slimbass Angle • Seafoam • Foamsorb • Widebaffle • Trap • Snowsorb • Stripesorb • Stripesorb ARC • Decoart • Swell • Basmel • Cookie

(B) Watercot

(A)

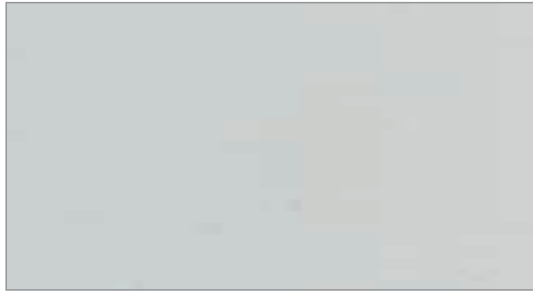

LIGHT GREY

MELAMINE FOAM BTEC G

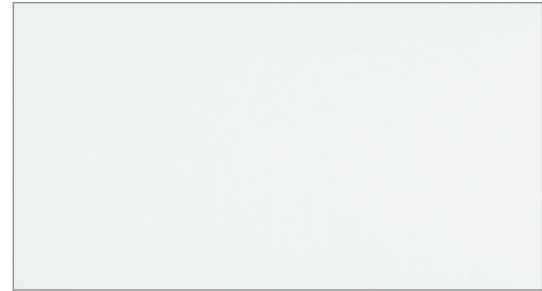

WHITE

MELAMINE FOAM BTEC G

(A)



GREY

ACOUSTIC FOAM PUR FR 25

(B)

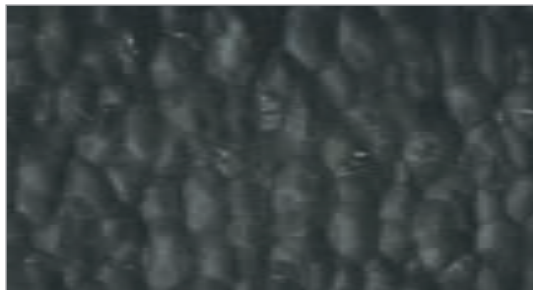

GREY

PE - CLOSED CELL POLYETHYLENE FOAM



WHITE

PE - CLOSED CELL POLYETHYLENE FOAM

NOTICE

- COLOURS MAY VARY DUE TO SUPPLIERS' CHANGES AND SOME DIFFERENCES MAY OCCUR IN TONAL RANGE.
- JOCAVI® ACCEPTS NO RESPONSABILITY FOR ANY PRINTING ERRORS.
- OTHER COLOURS UNDER CONSULTING AND WITH A MINIMUM QUANTITY ORDER.
- SPECIFICATIONS CAN BE MODIFIED WITHOUT PRIOR NOTICE, IF TECHNICAL OR COMMERCIAL REASONS SO REQUIRE.

VELVETY • FINISHINGS

VELVETY FINISHING COLOURS

BRANDS



MODELS

Seafoam • Foamsorb • Snowsorb • Swell • Decoart • Lownote W •
Lownote C • Cookie • Noven



RED

FLOCKED ACOUSTIC FOAM PUR FR 25



BLUE

FLOCKED ACOUSTIC FOAM PUR FR 25

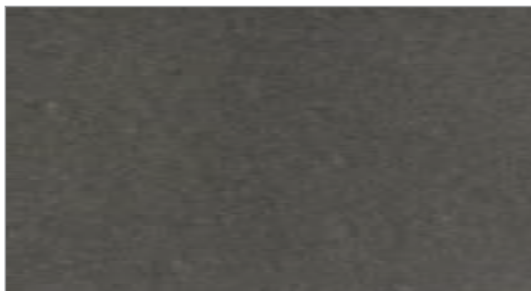

GREY

FLOCKED ACOUSTIC FOAM PUR FR 25

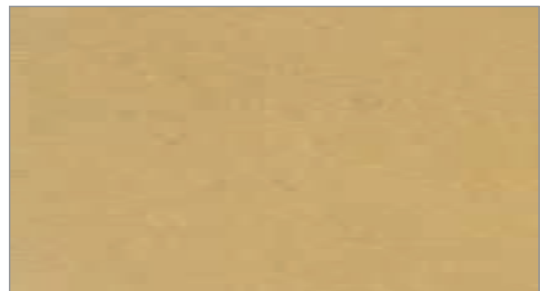

BEIGE

FLOCKED ACOUSTIC FOAM PUR FR 25



BLACK

FLOCKED ACOUSTIC FOAM PUR FR 25

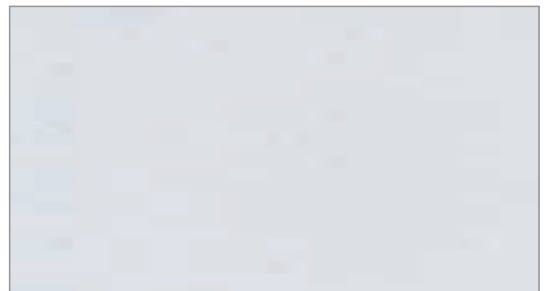

WHITE

FLOCKED ACOUSTIC FOAM PUR FR 25

NOTICE

- COLOURS MAY VARY DUE TO SUPPLIERS' CHANGES AND SOME DIFFERENCES MAY OCCUR IN TONAL RANGE.
- JOCAVI® ACCEPTS NO RESPONSABILITY FOR ANY PRINTING ERRORS.
- OTHER COLOURS UNDER CONSULTING AND WITH A MINIMUM QUANTITY ORDER.
- SPECIFICATIONS CAN BE MODIFIED WITHOUT PRIOR NOTICE, IF TECHNICAL OR COMMERCIAL REASONS SO REQUIRE.

PLASTIC • COLOURS

HIPS PLASTIC COLOURS

BRANDS



MODELS

Dynamicflow • Twin • Tuneflector • Effectfuser • Ripple • Plura
• Diamond

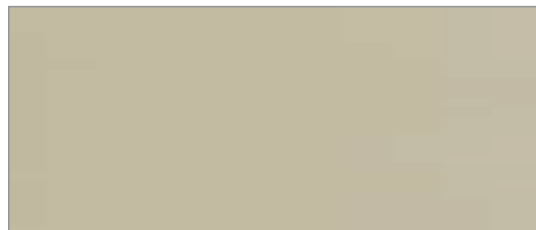

CREAM

APPROXIMATE / SIMILAR TO RAL 1001



RED

APPROXIMATE / SIMILAR TO RAL 3011



ORANGE

APPROXIMATE / SIMILAR TO RAL 2008



YELLOW

APPROXIMATE / SIMILAR TO RAL 1003



BLUE

APPROXIMATE / SIMILAR TO RAL 5013



PURPLE

APPROXIMATE / SIMILAR TO RAL 4005



BROWN

APPROXIMATE / SIMILAR TO RAL 8017

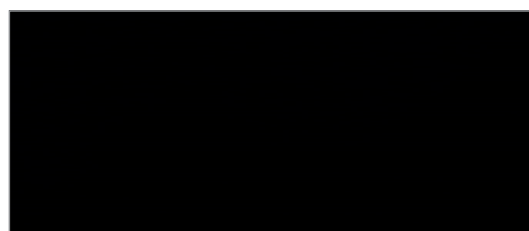

BLACK

APPROXIMATE / SIMILAR TO RAL 9005



GREY

APPROXIMATE / SIMILAR TO RAL 7042

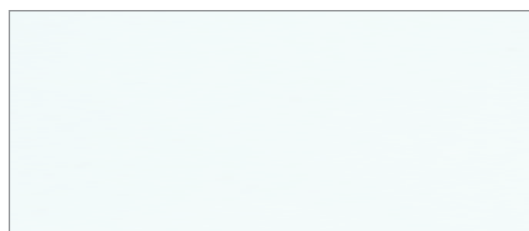

WHITE

APPROXIMATE / SIMILAR TO RAL 9003

NOTICE

- COLOURS MAY VARY DUE TO SUPPLIERS' CHANGES AND SOME DIFFERENCES MAY OCCUR IN TONAL RANGE.
- JOCAVI® ACCEPTS NO RESPONSABILITY FOR ANY PRINTING ERRORS.
- OTHER COLOURS UNDER CONSULTING AND WITH A MINIMUM QUANTITY ORDER.
- SPECIFICATIONS CAN BE MODIFIED WITHOUT PRIOR NOTICE, IF TECHNICAL OR COMMERCIAL REASONS SO REQUIRE.

WOOD • FINISHINGS

NATURAL WOOD AND WOOD VENEER FINISHINGS

BRANDS



MODELS

Wooddiffusor • Addisorb • Leaky FM • Woodfoil • Addisorb REV • Archtrap • ECOiso System • ECOiso ABL
• Woodface • Woodquad • Humcut BXA • Humcut BXW

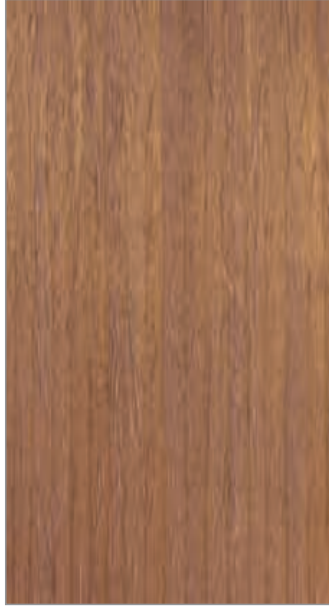

CHERRY



OAK



PINE



MAHOGANY



BLACK-BROWN



SUCUPIRA

NOTICE

- COLOURS MAY VARY DUE TO SUPPLIERS' CHANGES AND SOME DIFFERENCES MAY OCCUR IN TONAL RANGE.
- JOCAVI® ACCEPTS NO RESPONSABILITY FOR ANY PRINTING ERRORS.
- OTHER COLOURS UNDER CONSULTING AND WITH A MINIMUM QUANTITY ORDER.
- SPECIFICATIONS CAN BE MODIFIED WITHOUT PRIOR NOTICE, IF TECHNICAL OR COMMERCIAL REASONS SO REQUIRE.

BRANDS



MODELS

Cerareflector • Squarydiffusor

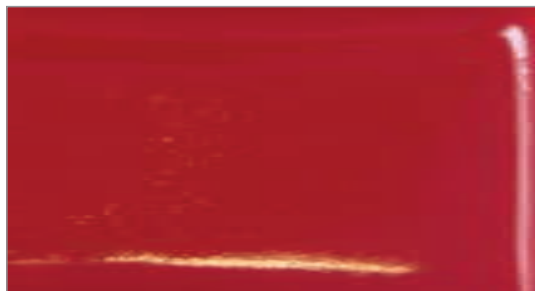

RED



BLACK



YELLOW

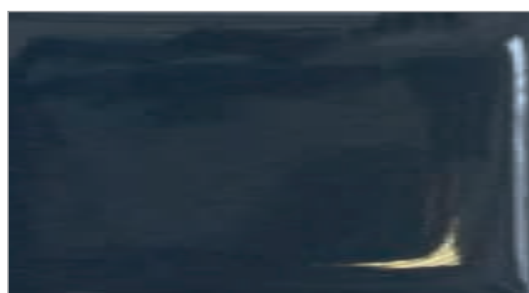

GREY



CREAM

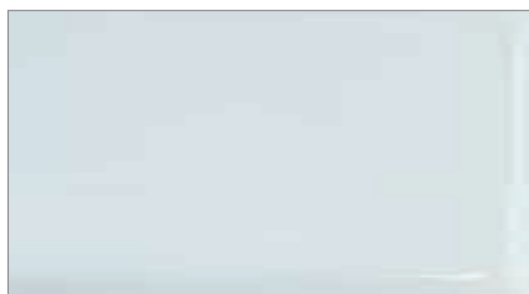

WHITE

NOTICE

- COLOURS MAY VARY DUE TO SUPPLIERS' CHANGES AND SOME DIFFERENCES MAY OCCUR IN TONAL RANGE.
- JOCAVI® ACCEPTS NO RESPONSABILITY FOR ANY PRINTING ERRORS.
- OTHER COLOURS UNDER CONSULTING AND WITH A MINIMUM QUANTITY ORDER.
- SPECIFICATIONS CAN BE MODIFIED WITHOUT PRIOR NOTICE, IF TECHNICAL OR COMMERCIAL REASONS SO REQUIRE.

MINERAL • COLOURS

GRANULATED MINERAL COLOURS

BRANDS



MODELS

Staidtreat BXA/SP • Staidtreat BXW • Staidtreat WBA/SP



RED APPROXIMATE TO RAL 3013



BLUE APPROXIMATE TO RAL 5010



GREY APPROXIMATE TO RAL 7001



BROWN APPROXIMATE TO RAL 8002



MAROON APPROXIMATE TO RAL 8015



BLACK APPROXIMATE TO RAL 9005

NOTICE

- COLOURS MAY VARY DUE TO SUPPLIERS' CHANGES AND SOME DIFFERENCES MAY OCCUR IN TONAL RANGE.
- JOCAVI® ACCEPTS NO RESPONSABILITY FOR ANY PRINTING ERRORS.
- OTHER COLOURS UNDER CONSULTING AND WITH A MINIMUM QUANTITY ORDER.
- SPECIFICATIONS CAN BE MODIFIED WITHOUT PRIOR NOTICE, IF TECHNICAL OR COMMERCIAL REASONS SO REQUIRE.

ENGINEERED • COLOURS

ENGINEERED COLOURED WOOD FIBRE BOARD FINISHINGS

BRANDS



MODELS

Addsorb • Leaky FM • Addsorb REV • ECOiso System • ECOiso ABL • Woodface • Humcut BXA / BXW



YELLOW



ORANGE



RED



GREEN



BLUE

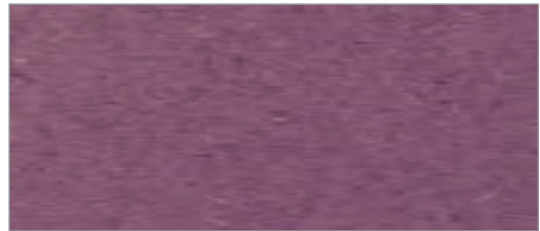

PURPLE



BROWN



BLACK



GREY



LIGHT GREY

NOTICE

- COLOURS MAY VARY DUE TO SUPPLIERS' CHANGES AND SOME DIFFERENCES MAY OCCUR IN TONAL RANGE.
- JOCAVI® ACCEPTS NO RESPONSABILITY FOR ANY PRINTING ERRORS.
- OTHER COLOURS UNDER CONSULTING AND WITH A MINIMUM QUANTITY ORDER.
- SPECIFICATIONS CAN BE MODIFIED WITHOUT PRIOR NOTICE, IF TECHNICAL OR COMMERCIAL REASONS SO REQUIRE.

FACED BOARD • FINISHINGS

WOOD FACED BOARDS FINISHINGS

BRANDS



MODELS

Slimbass Angle • Slimbass Wall • Cosmos • LF Cosmos

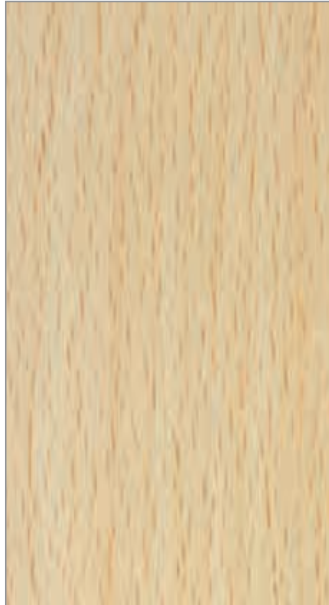

BEECH



OAK



CHERRY

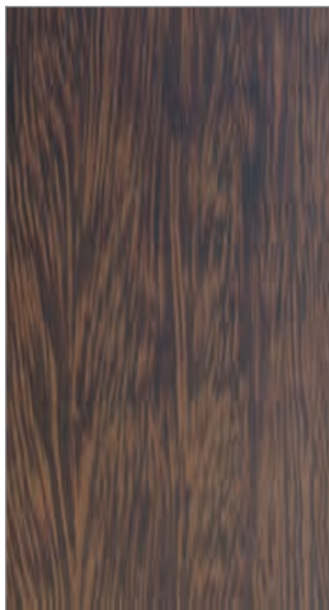

SUCUPIRA



GREY

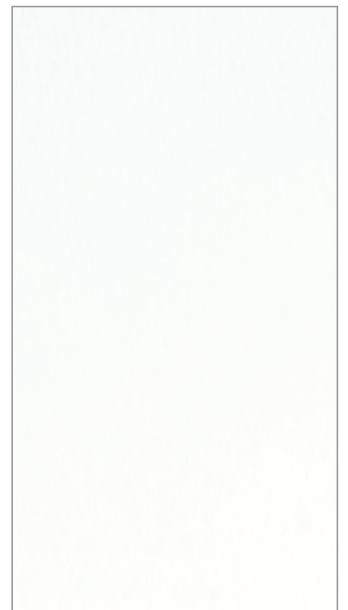

WHITE

NOTICE

- COLOURS MAY VARY DUE TO SUPPLIERS' CHANGES AND SOME DIFFERENCES MAY OCCUR IN TONAL RANGE.
- JOCAVI® ACCEPTS NO RESPONSABILITY FOR ANY PRINTING ERRORS.
- OTHER COLOURS UNDER CONSULTING AND WITH A MINIMUM QUANTITY ORDER.
- SPECIFICATIONS CAN BE MODIFIED WITHOUT PRIOR NOTICE, IF TECHNICAL OR COMMERCIAL REASONS SO REQUIRE.

MOTIF • FINISHINGS

WOOD AND FABRIC IMAGE PRINTED FINISHINGS

BRANDS



MODELS

- (A)** Convexabsorber • Mellowalltrap • Mellowcloud ABS • Lightwalltrap • Ebony • Mellowaffle • Basscorner • Roundbasscorner • Basslayer • Walltrap • Tubabsorber
- (B)** Addsorber • Leaky FM

(A)



ON FABRIC

IMAGE PRINTED FINISHING

(B)

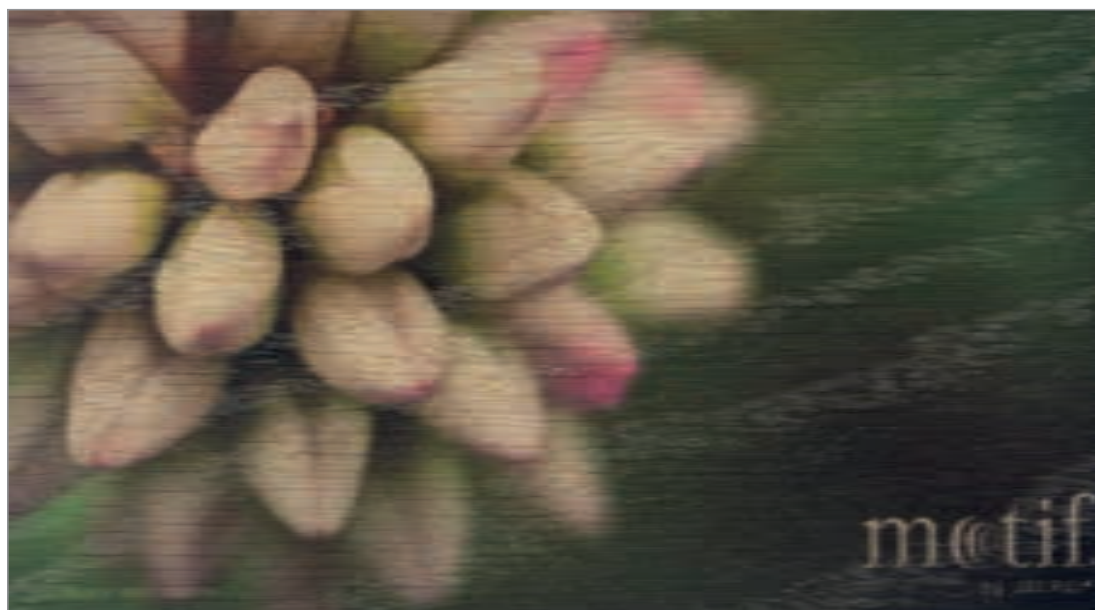

ON WOOD

IMAGE PRINTED FINISHING

NOTICE

- COLOURS MAY VARY DUE TO SUPPLIERS' CHANGES AND SOME DIFFERENCES MAY OCCUR IN TONAL RANGE.
- JOCAVI® ACCEPTS NO RESPONSABILITY FOR ANY PRINTING ERRORS.
- OTHER COLOURS UNDER CONSULTING AND WITH A MINIMUM QUANTITY ORDER.
- SPECIFICATIONS CAN BE MODIFIED WITHOUT PRIOR NOTICE, IF TECHNICAL OR COMMERCIAL REASONS SO REQUIRE.

BRANDS



MODELS

ECOiso SYSTEM • ECOiso ABL • ECOiso SPL • ECOiso NCF • Quadcork • Quadcork OUTLINE
• GroutPAINT



CORK

NATURAL EXPANDED CORK AGGLOMERATE



COCONUT FIBRE

NATURAL COCONUT FIBRE

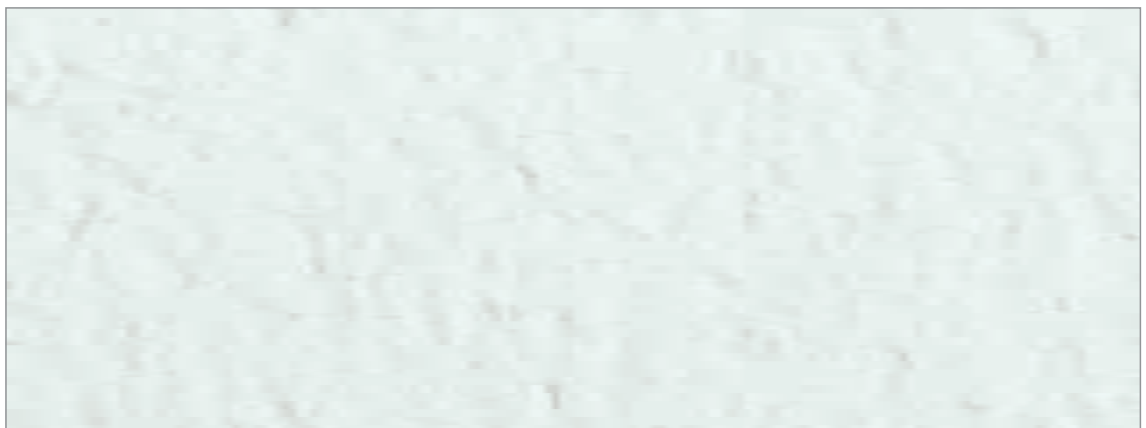

WATER-BASED ELASTIC VIBRATION PAINT

NOTICE

- COLOURS MAY VARY DUE TO SUPPLIERS' CHANGES AND SOME DIFFERENCES MAY OCCUR IN TONAL RANGE.
- JOCAVI® ACCEPTS NO RESPONSABILITY FOR ANY PRINTING ERRORS.
- OTHER COLOURS UNDER CONSULTING AND WITH A MINIMUM QUANTITY ORDER.
- SPECIFICATIONS CAN BE MODIFIED WITHOUT PRIOR NOTICE, IF TECHNICAL OR COMMERCIAL REASONS SO REQUIRE.

BRANDS



MODELS

Airflat • Airgrid • Airperf • Wallperf • Airholed • Airbillow • Airtube • Floatsheet
INS • Floatsheet VIB

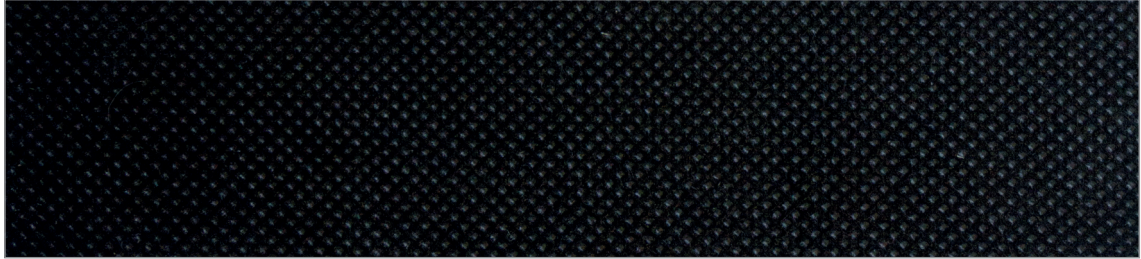

VISELIKE FABRIC



PERFORATED GRID



PERFORATED METAL LACQUERED PLATE

OTHER PERFORATIONS AVAILABLE ON DEMAND



POLYURETHANE ACOUSTIC LAYER

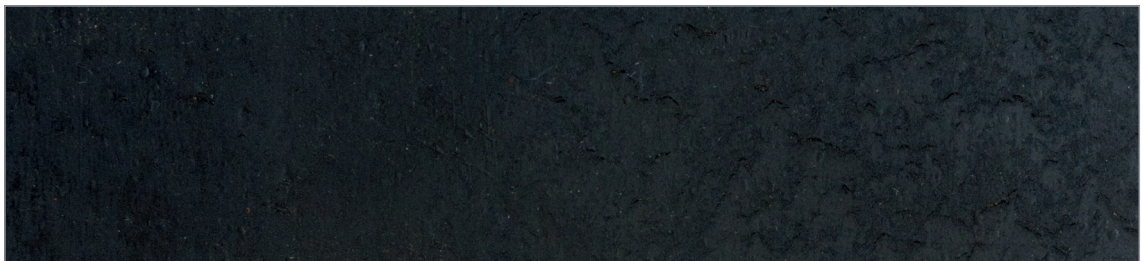

BITUMEN DAMPING COMPOUND

NOTICE

- COLOURS MAY VARY DUE TO SUPPLIERS' CHANGES AND SOME DIFFERENCES MAY OCCUR IN TONAL RANGE.
- JOCAMI® ACCEPTS NO RESPONSABILITY FOR ANY PRINTING ERRORS.
- OTHER COLOURS UNDER CONSULTING AND WITH A MINIMUM QUANTITY ORDER.
- SPECIFICATIONS CAN BE MODIFIED WITHOUT PRIOR NOTICE, IF TECHNICAL OR COMMERCIAL REASONS SO REQUIRE.

STANDARD PET • COLOURS

POLYESTER ACOUSTIC BOARD COLOURS

BRANDS



MODELS

• PETREV • WALLPART • JMORSE

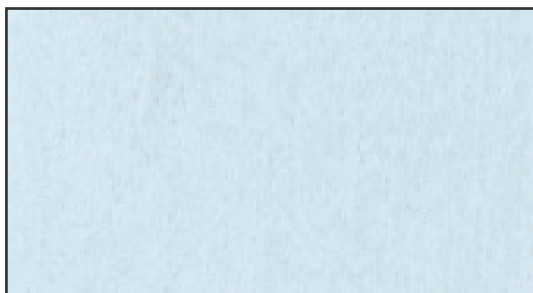

WHITE - MHL - M05 - Similar to RAL 9003

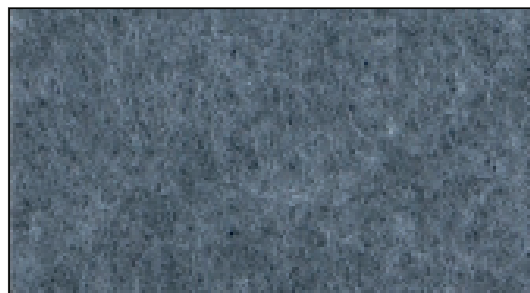

GREY - MHL - M28 - Similar to RAL 7031



BEIGE - MHL - M01 - Similar to RAL 9001



BLUE - MHL - M22 - Similar to RAL 5002

NOTICE

- COLOURS MAY VARY DUE TO SUPPLIERS' CHANGES AND SOME DIFFERENCES MAY OCCUR IN TONAL RANGE.
- JOCAVI® ACCEPTS NO RESPONSABILITY FOR ANY PRINTING ERRORS.
- OTHER COLOURS UNDER CONSULTING AND WITH A MINIMUM QUANTITY ORDER.
- SPECIFICATIONS CAN BE MODIFIED WITHOUT PRIOR NOTICE, IF TECHNICAL OR COMMERCIAL REASONS SO REQUIRE.

ACCESSORIES

ACCESSORIES AND PANELS' HARDWARE

BRANDS



MODELS

For all models and JOCAVI brands' products



NYLON SUSPENSION CABLES

ATP MODELS



STEEL SUSPENSION CABLES

JOCAVI MODELS

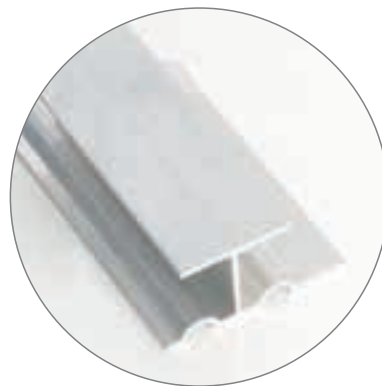

ALUMINIUM BARS

JOCAVI MODELS

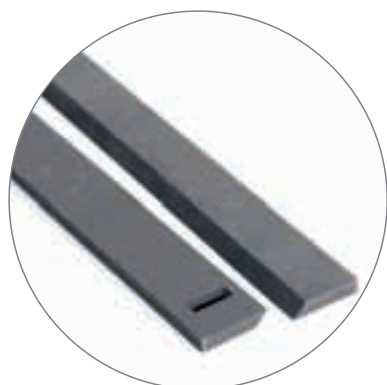

REMOVABLE MOUNTING STRIPES (PAIR)

JOCAVI AND ATP MODELS



TUBE PU GLUE UV + HUMIDITY RESISTANCE

FOR ALL BRANDS



CONTACT GLUE

FOR PRODUCTS OF ALL BRANDS

NOTICE

- COLOURS MAY VARY DUE TO SUPPLIERS' CHANGES AND SOME DIFFERENCES MAY OCCUR IN TONAL RANGE.
- JOCAVI® ACCEPTS NO RESPONSABILITY FOR ANY PRINTING ERRORS.
- OTHER COLOURS UNDER CONSULTING AND WITH A MINIMUM QUANTITY ORDER.
- SPECIFICATIONS CAN BE MODIFIED WITHOUT PRIOR NOTICE, IF TECHNICAL OR COMMERCIAL REASONS SO REQUIRE.

PERFORATIONS • BRANDS' AVAILABLE PERFORATIONS

CUSTOM MADE NATURAL WOOD AND ENGINEERED WOOD

BRANDS



MODELS

Addsorb • Leaky FM • ECOiso System • ECOiso ABL • Woodface • Humcut BXA / BXW • Cosmos • LF Cosmos • Noven

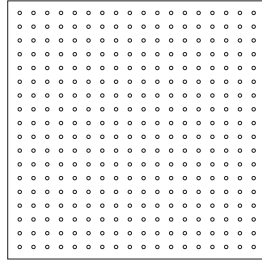

ADD060/120/180

PERFORATION (%/m²): **4,53 %**

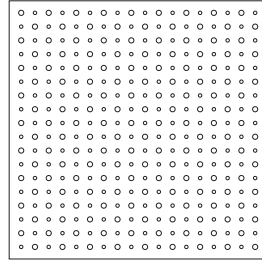

HC060/120/180

PERFORATION (%/m²): **7,36 %**

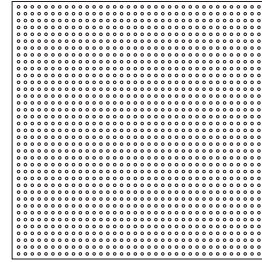

WP0616060/120/180

PERFORATION (%/m²): **10,75 %**

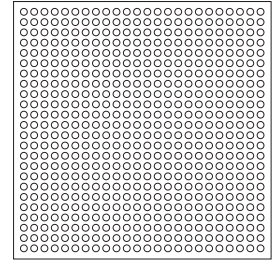

WP1624060/120/180

PERFORATION (%/m²): **32,17 %**

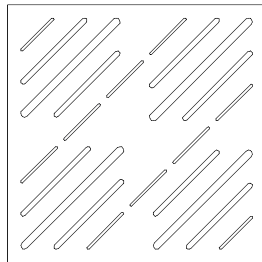

CTR060

PERFORATION (%/m²): **14,14 %**

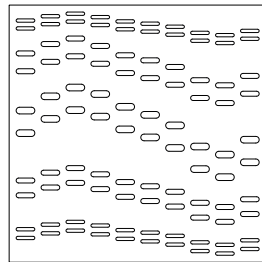

SP060/120

PERFORATION (%/m²): **12,42 %**

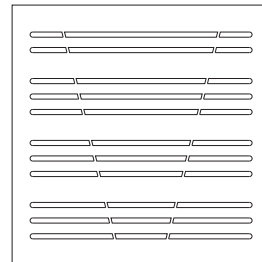

SL060/120/180

PERFORATION (%/m²): **18,39 %**

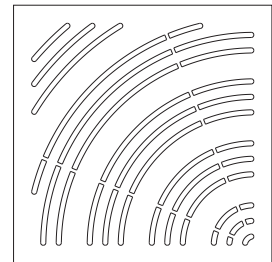

S060/120

PERFORATION (%/m²): **17,73 %**

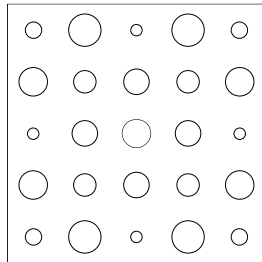

HOL060

PERFORATION (%/m²): **14,31 %**

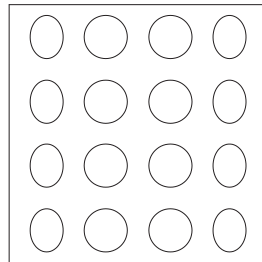

FM060/120/180

PERFORATION (%/m²): **31,00 %**

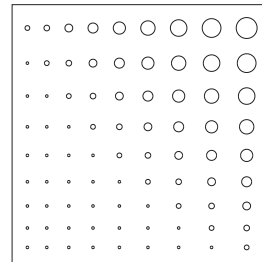

G060/120

PERFORATION (%/m²): **6,22 %**

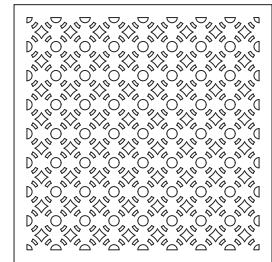

C060/120/180

PERFORATION (%/m²): **20,72 %**

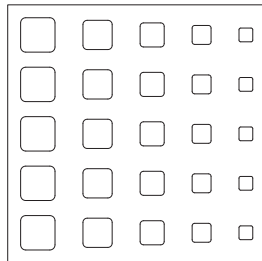

C060/120/180

PERFORATION (%/m²): **12,03 %**

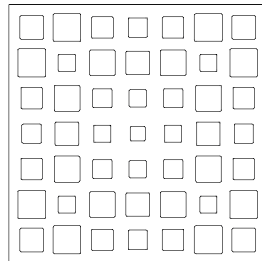

QRD060

PERFORATION (%/m²): **37,95 %**

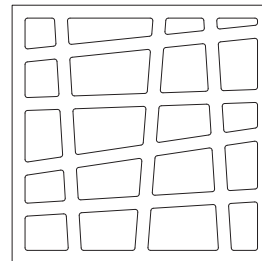

T060/120/180

PERFORATION (%/m²): **52,22 %**

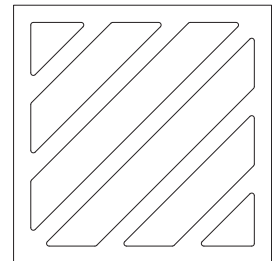

D060/120/180

PERFORATION (%/m²): **51,31 %**

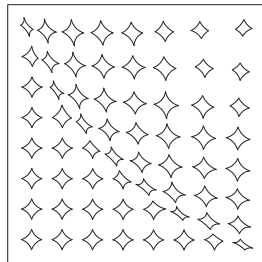

3D060/120

PERFORATION (%/m²): **13,47 %**

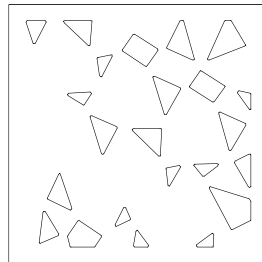

KLMT060

PERFORATION (%/m²): **13,78 %**

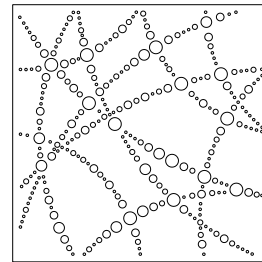

COS060/120

PERFORATION (%/m²): **10,17 %**

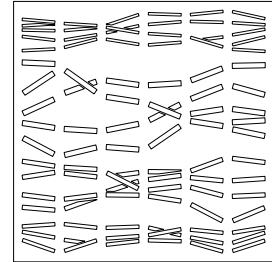

RT060/120

PERFORATION (%/m²): **17,33 %**

NOTICE

- COLOURS MAY VARY DUE TO SUPPLIERS' CHANGES AND SOME DIFFERENCES MAY OCCUR IN TONAL RANGE.
- JOCAVI® ACCEPTS NO RESPONSABILITY FOR ANY PRINTING ERRORS.
- OTHER COLOURS UNDER CONSULTING AND WITH A MINIMUM QUANTITY ORDER.
- SPECIFICATIONS CAN BE MODIFIED WITHOUT PRIOR NOTICE, IF TECHNICAL OR COMMERCIAL REASONS SO REQUIRE.

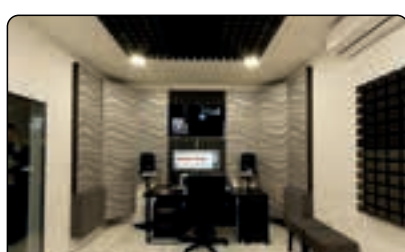
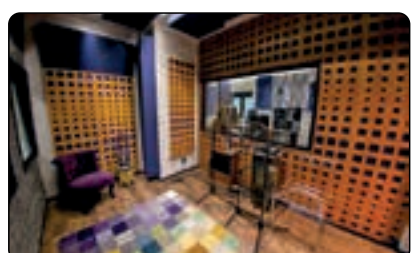
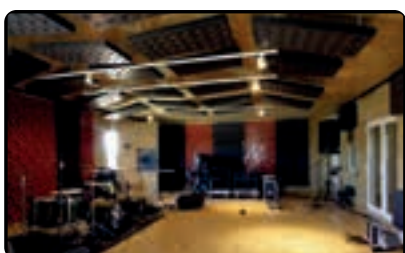
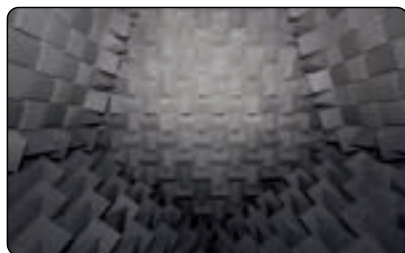
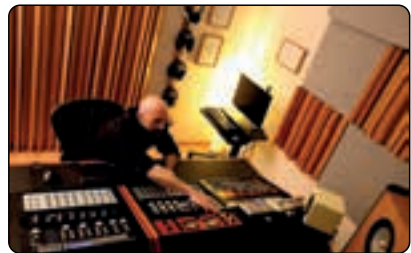
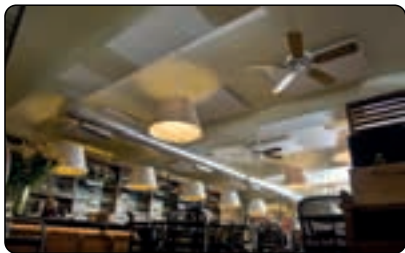



JOCAVI International

Av. Pedro Álvares Cabral
Sintra Estoril V - B18
2710-297 Sintra, Portugal
Tel: (+351) 21 924 30 97
Email: info@jocavi.net
www.jocavi.net

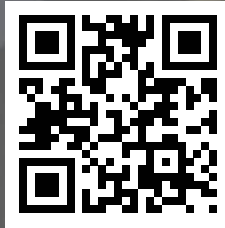

JOCAVI USA Corporation

46-B Ferry Street, Unit 196
07105 Newark, NJ, US
Tel: +1 (973) 536 18 32
Tel: +1 (917) 294 34 11
Email: info@jocaviusa.com
www.jocaviusa.com

